

O	S		V
O	S		V

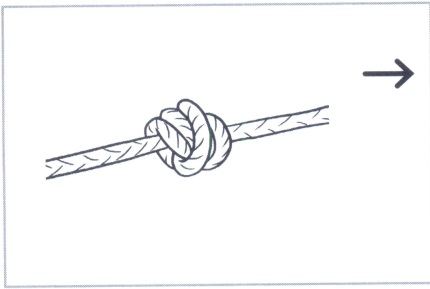

O	D		N
O	D		N

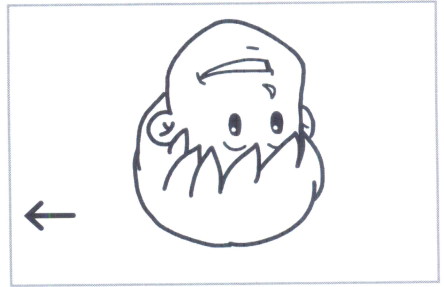
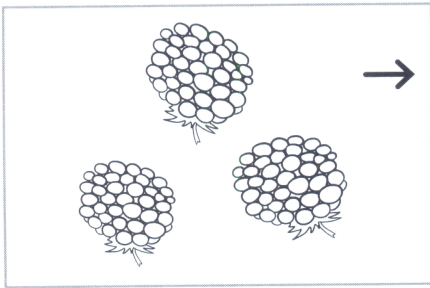
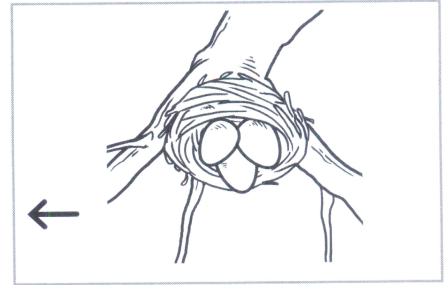

E	R		M
E	R		M

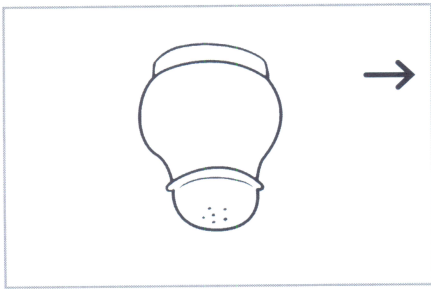
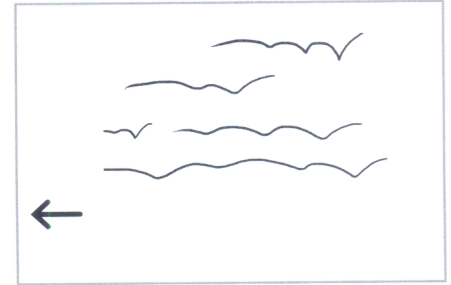

E	L		S
E	L		S

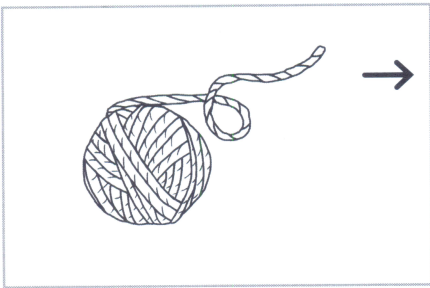
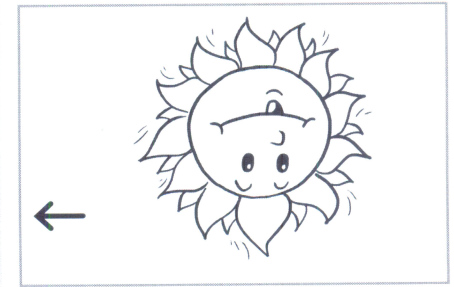

A	N		L
A	N		L

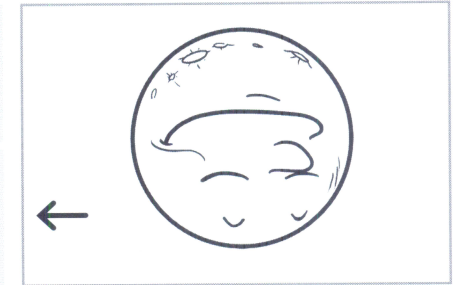

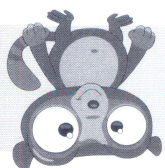
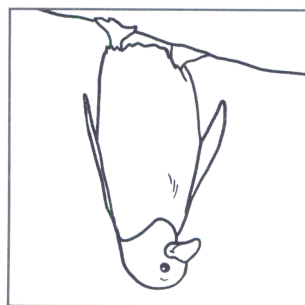
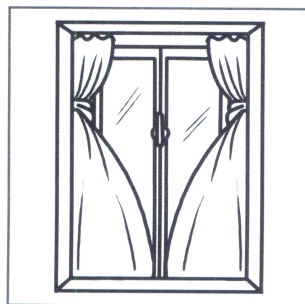
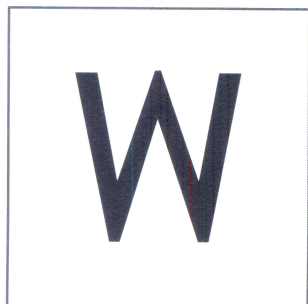
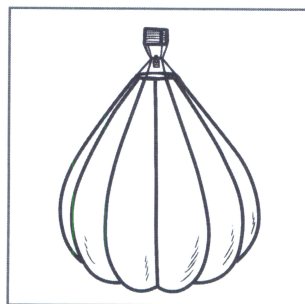
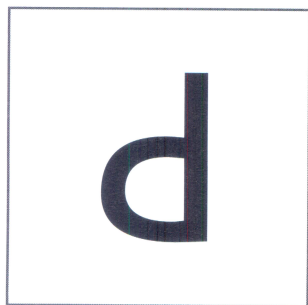
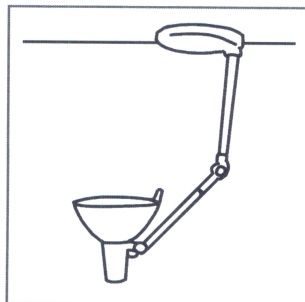
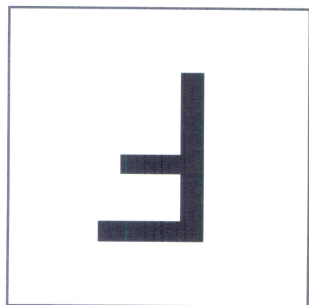

COLLEGA OGNI DISEGNO ALLA CONSONANTE  
CORRISPONDENTE

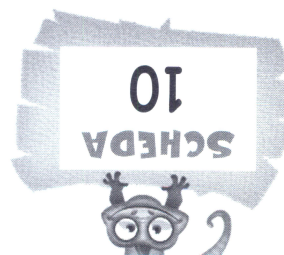



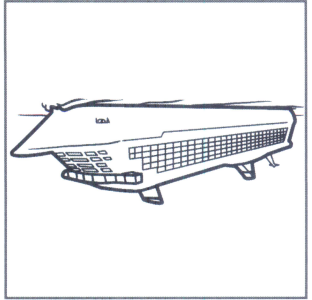
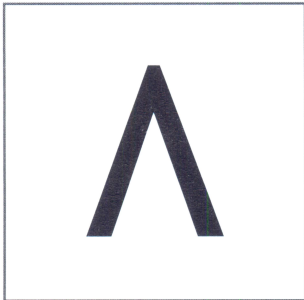
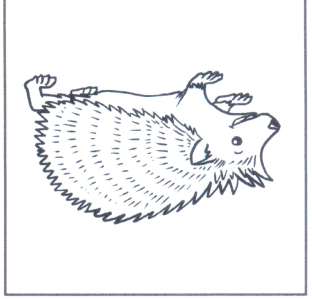
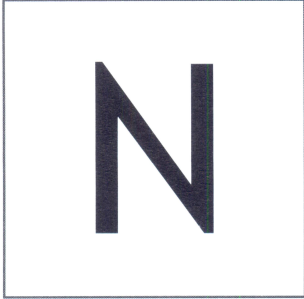
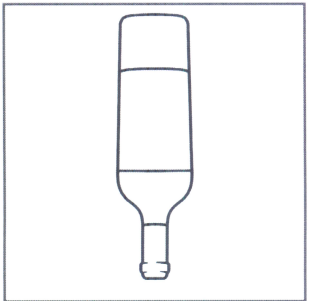
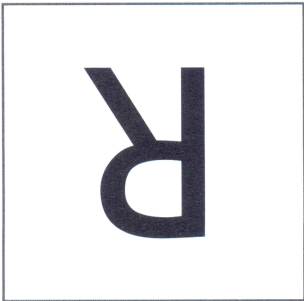
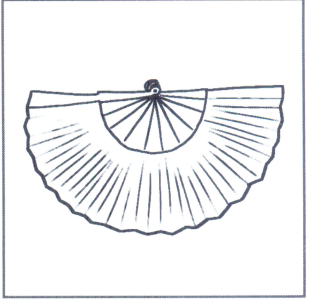

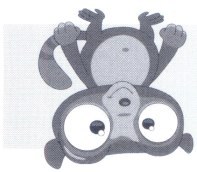
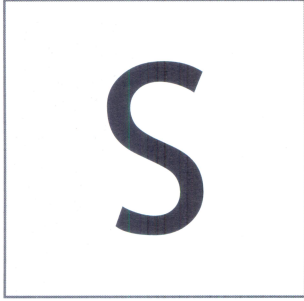
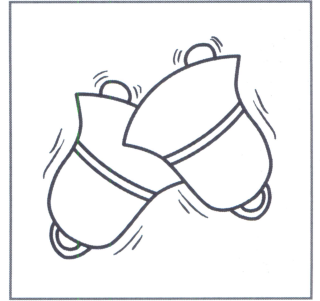
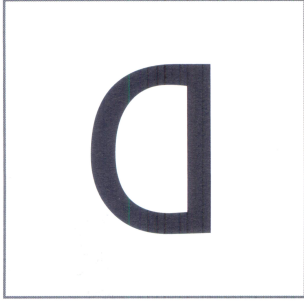
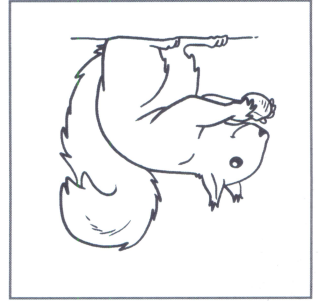
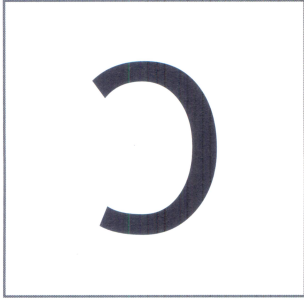
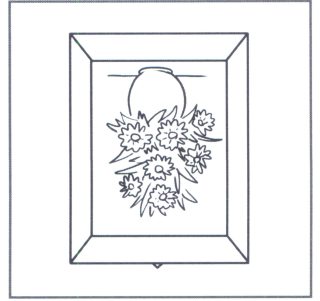
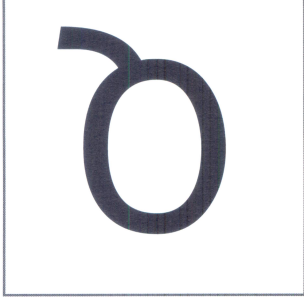
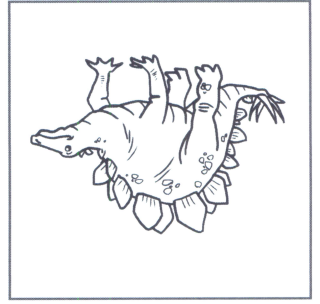

COLLEGA OGNI DISEGNO ALLA CONSONANTE  
CORRISPONDENTE

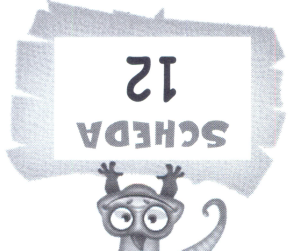

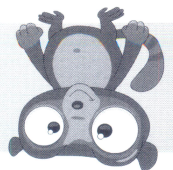
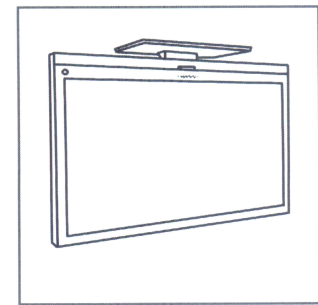
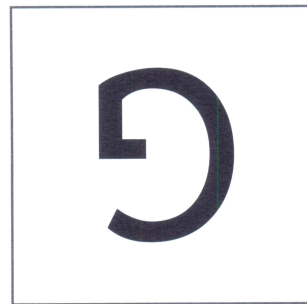
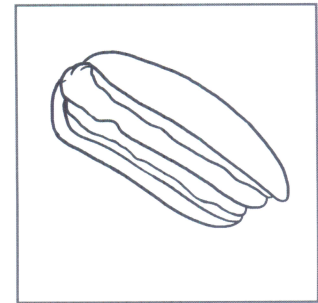
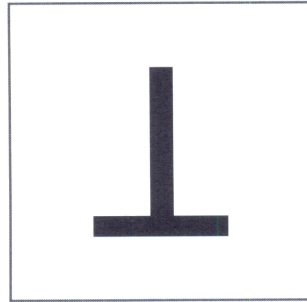
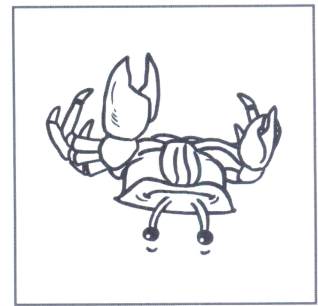
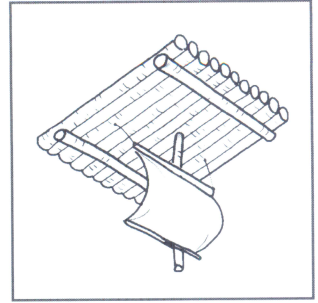
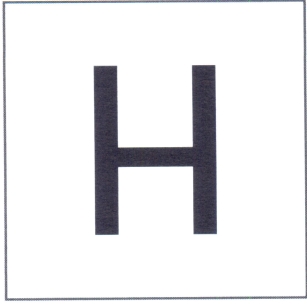



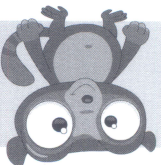
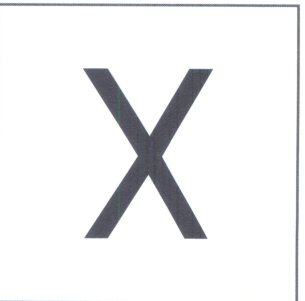
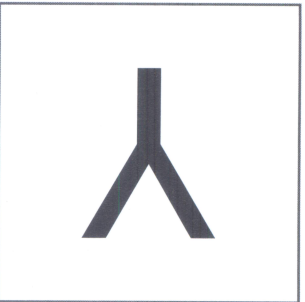
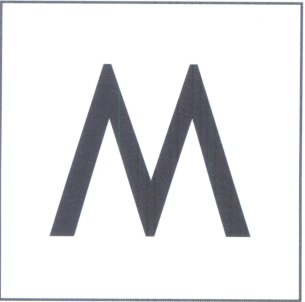
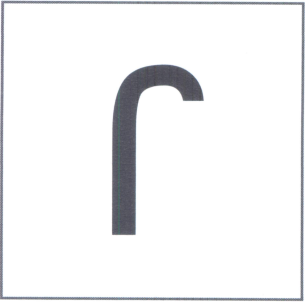
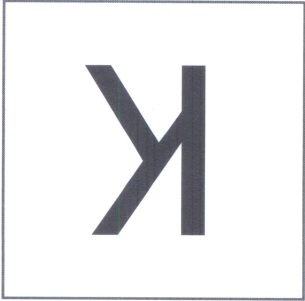
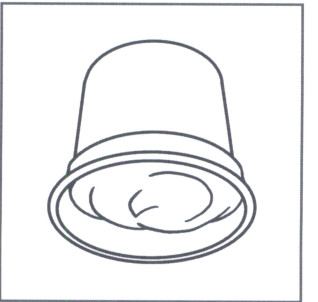
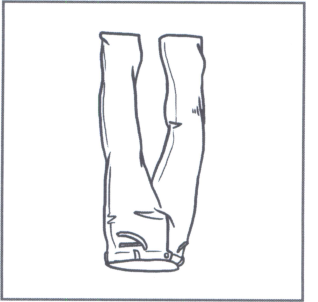
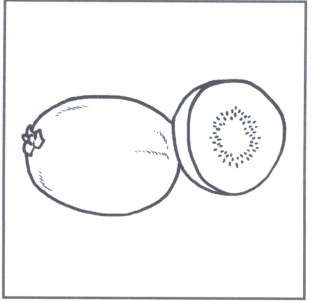
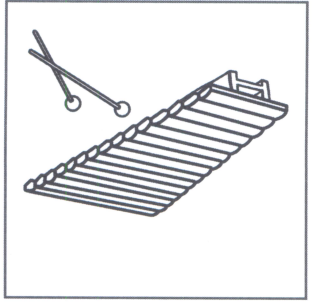
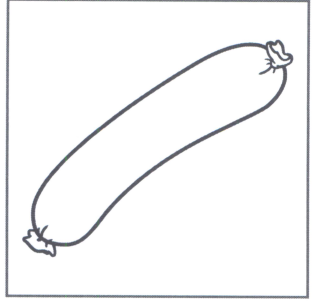

A M O L A



S A O N E

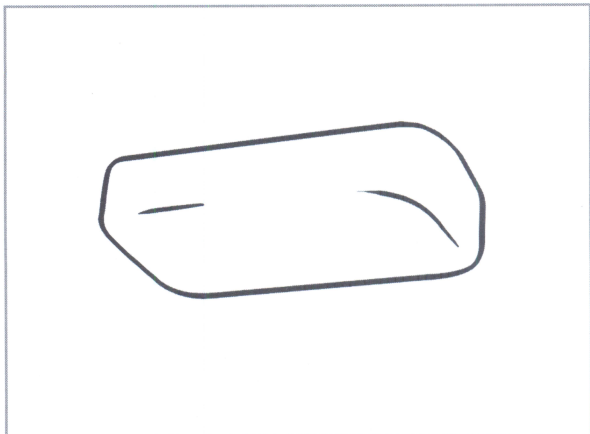

O L I O

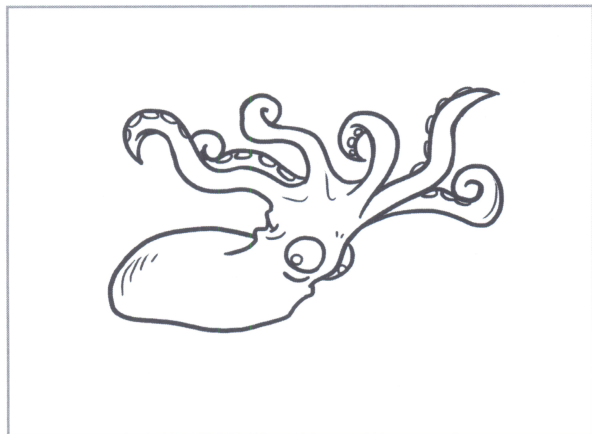

I T A

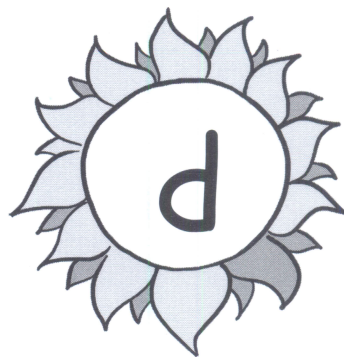
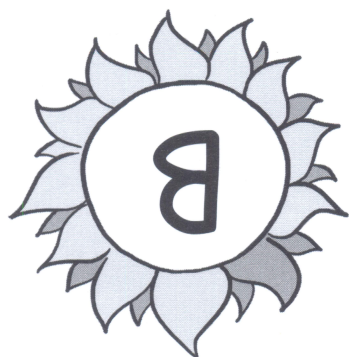
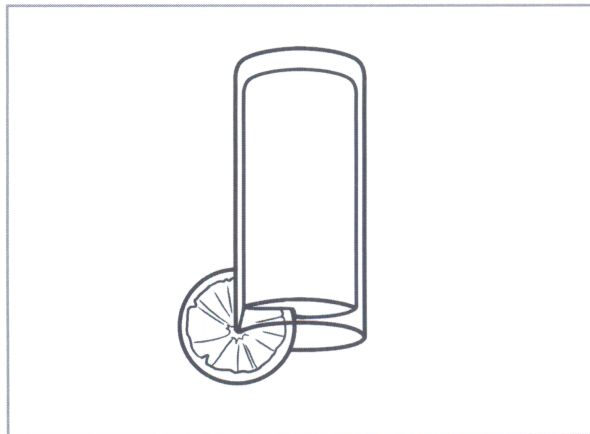

COMPLETA LE PAROLE INSERENDO « P » O « B »

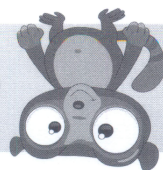

U E R I

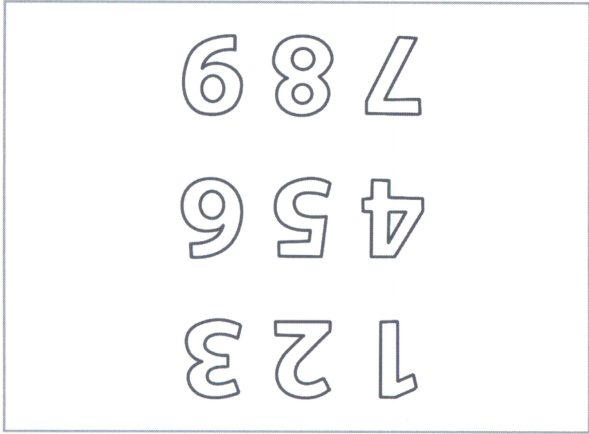

U L I O

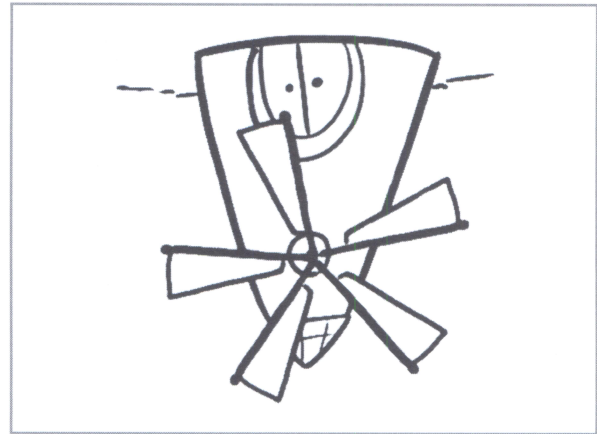

A T I T E

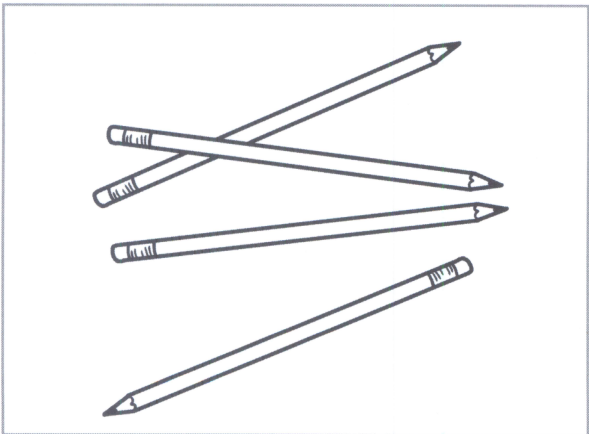

U V O L E

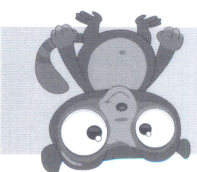
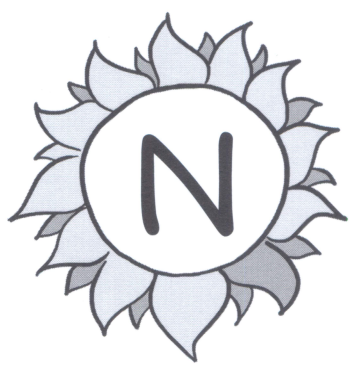
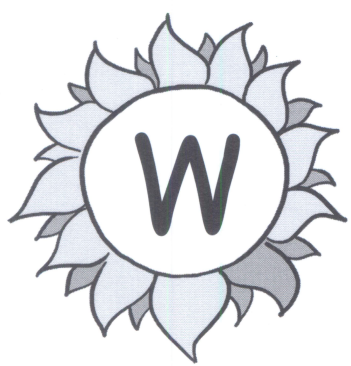
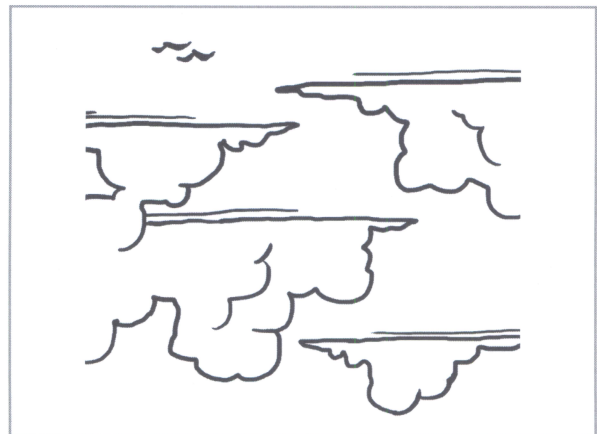

COMPLETA LE PAROLE INSERENDO «N» O «M»

16  
SCHEDA





A E N A

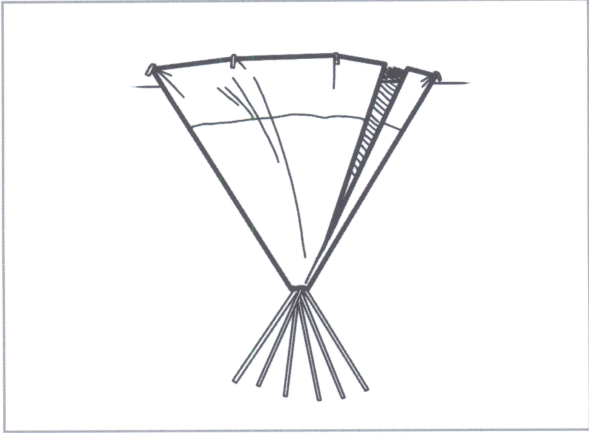

I E N I

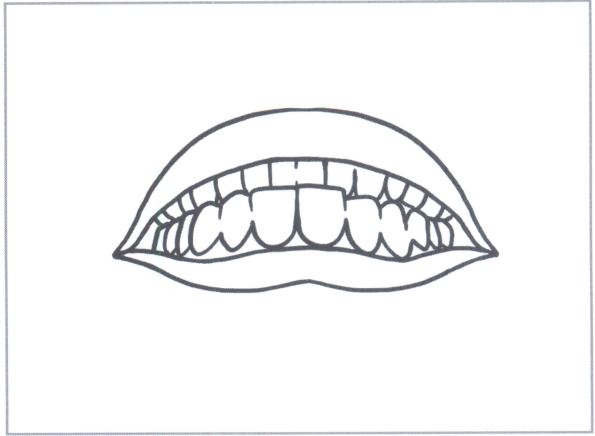

A S P A A

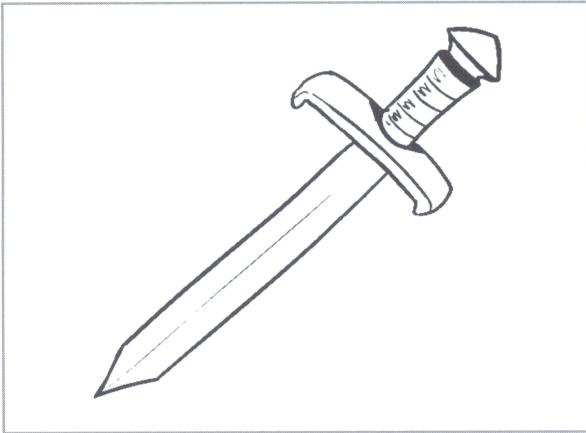

A O R A

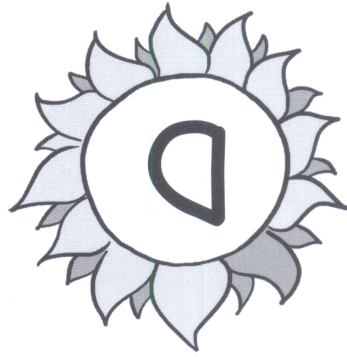
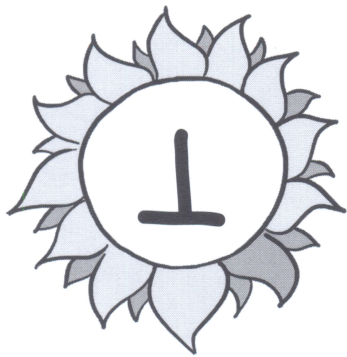
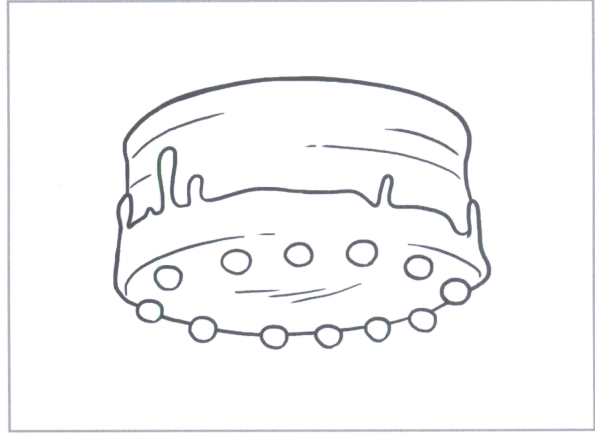

COMPLETA LE PAROLE INSERENDO « D » O « T »

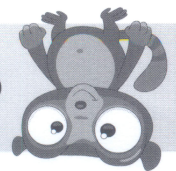

I G I L E

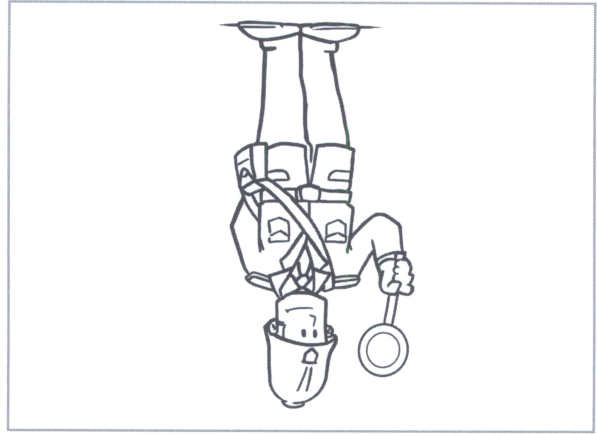

A O L A

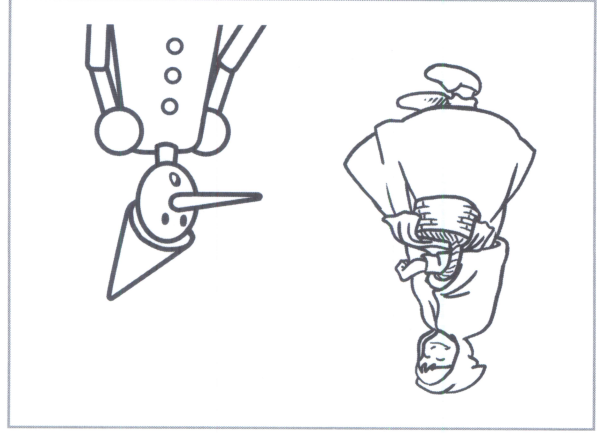

O G L I A

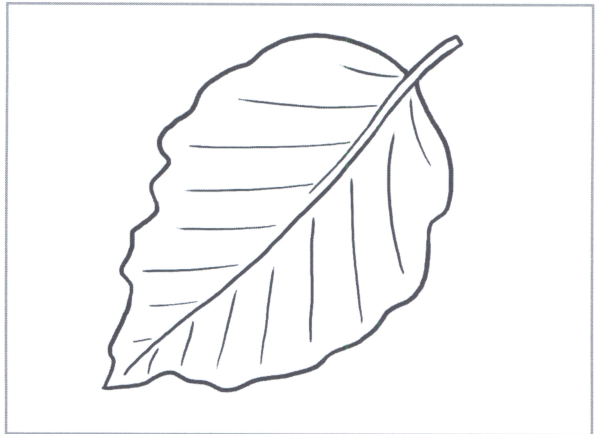

D I A N O

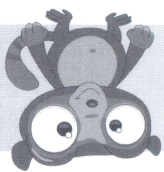
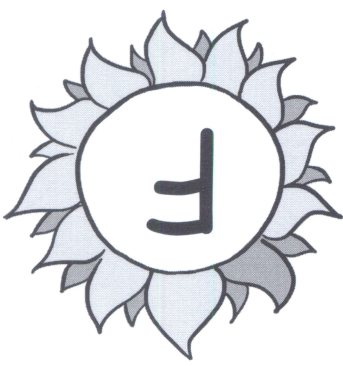
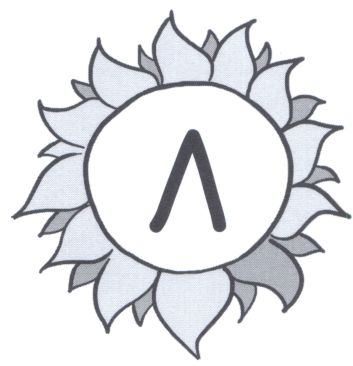
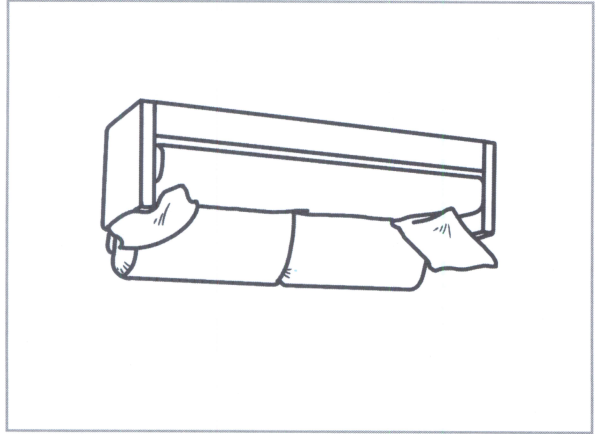



I M O N E

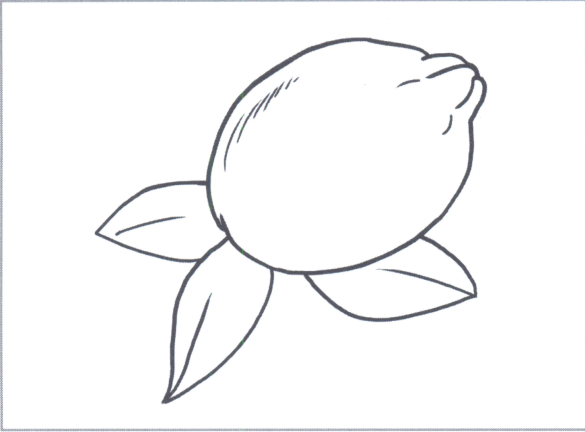

A B B E O

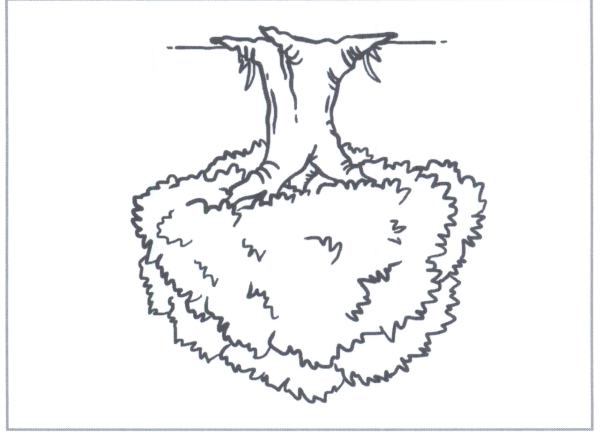

G E A T O



C O I O

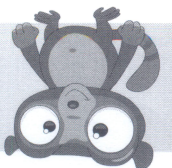
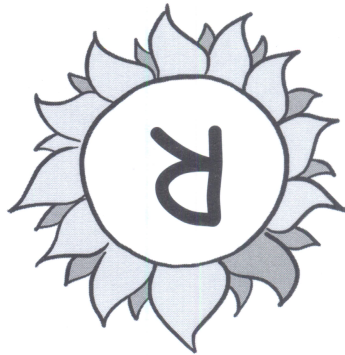
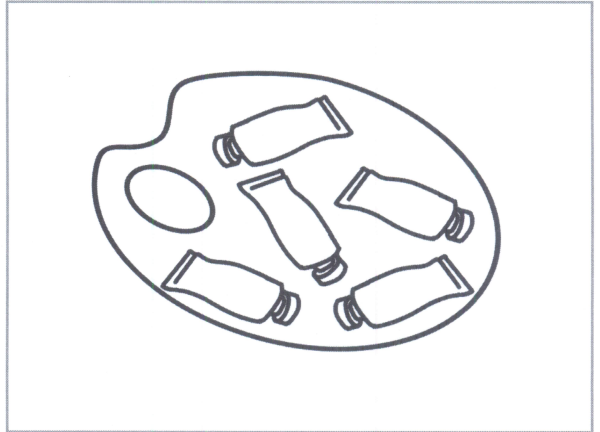



O R R O

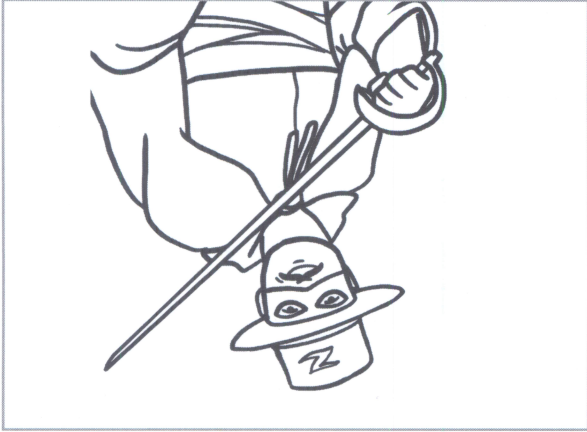

B O R A

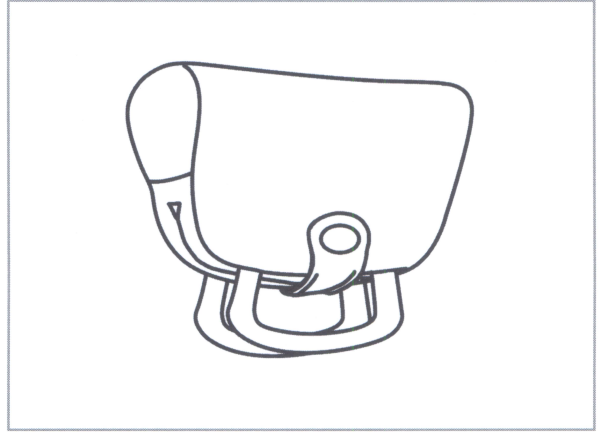

R O A



R A O

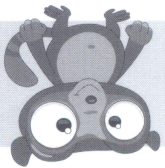
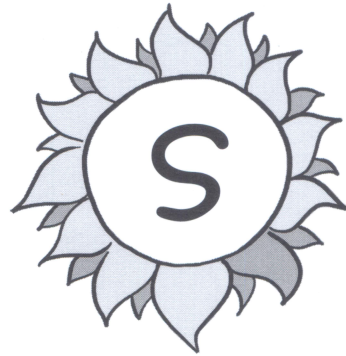
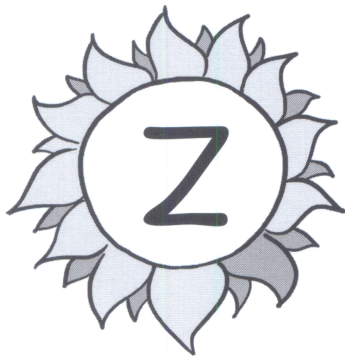
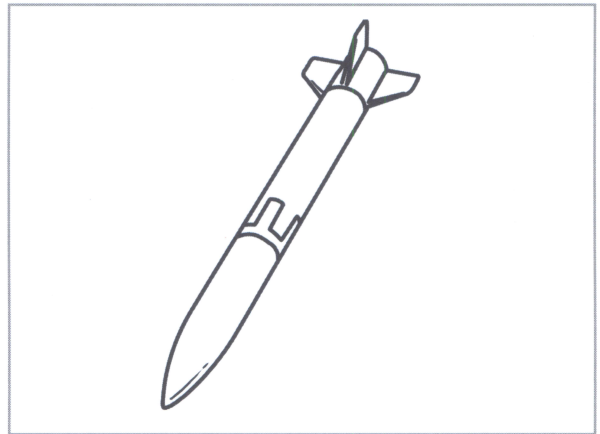

COMPLETA LE PAROLE INSERENDO «S» O «Z»

SCHEDA  
20



O R T A

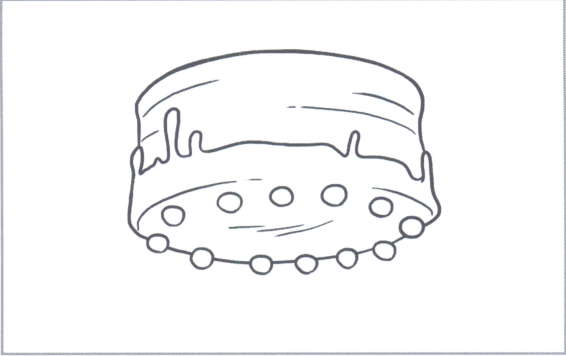

E R E O

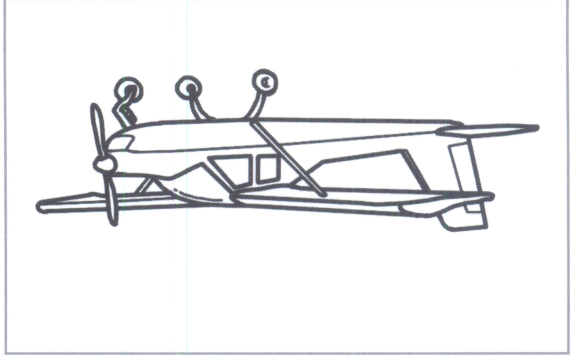

A L L A

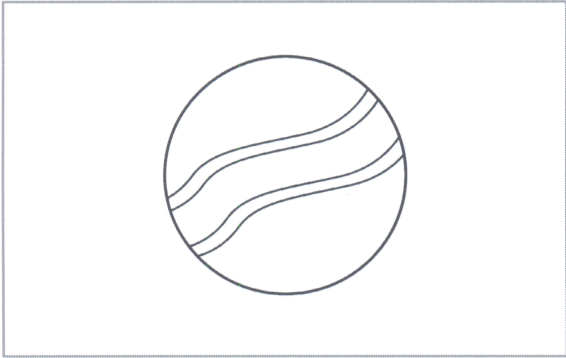

I O R I

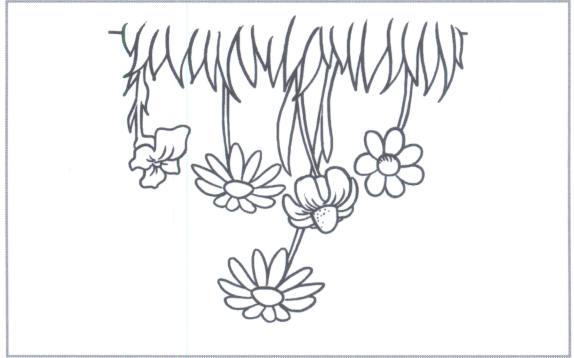

E S C I

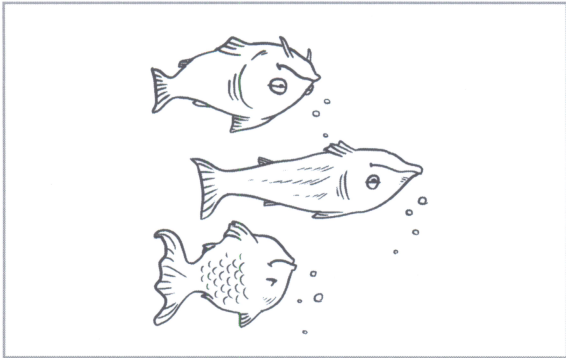

A G N O

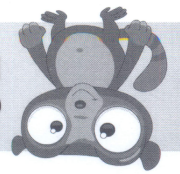
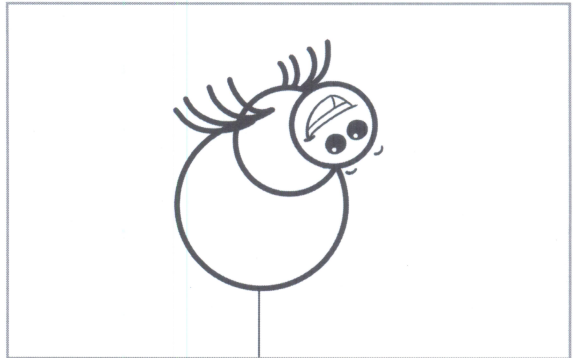



V I O

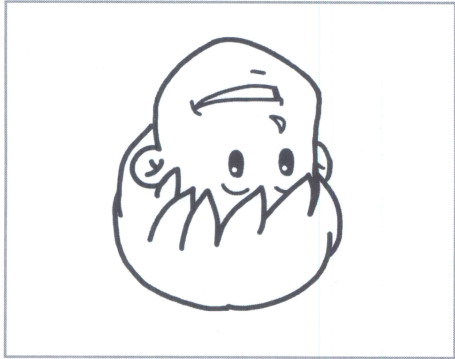

A U O

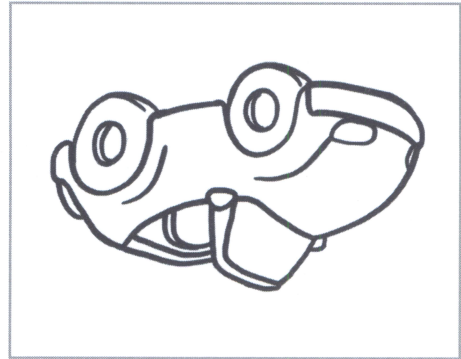

S O E

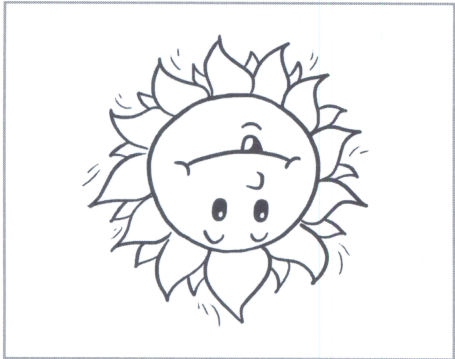

Z E O

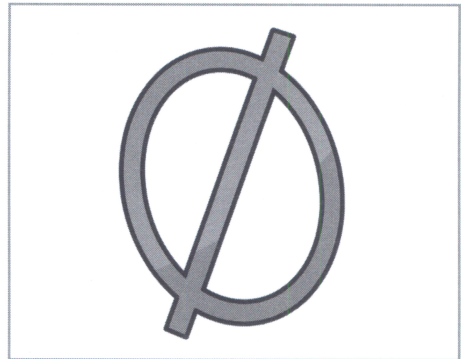

W E E

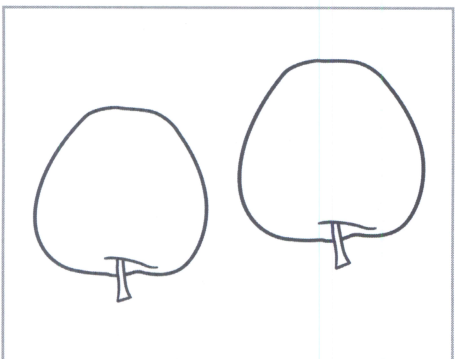

D I O

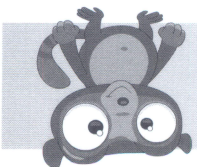
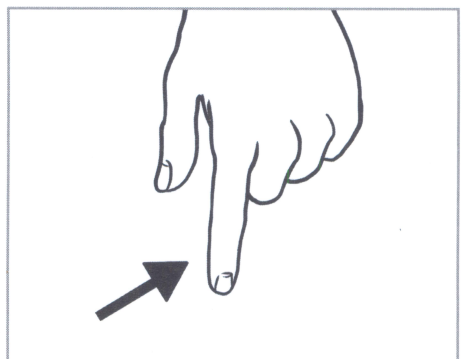

OSSERVA IL DISEGNO E INSERISCI LA LETTERA MANCANTE

22  
 SCHEDA



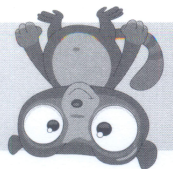
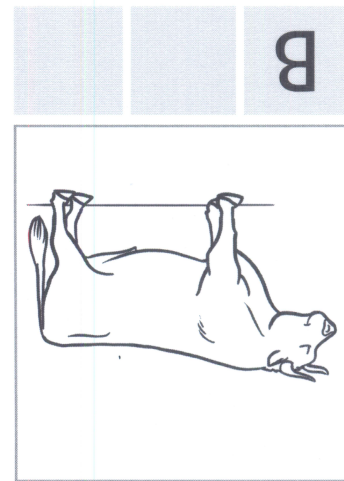
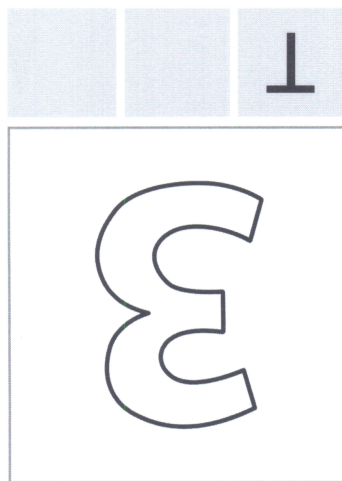
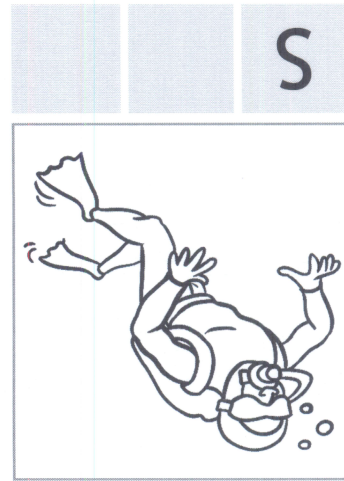
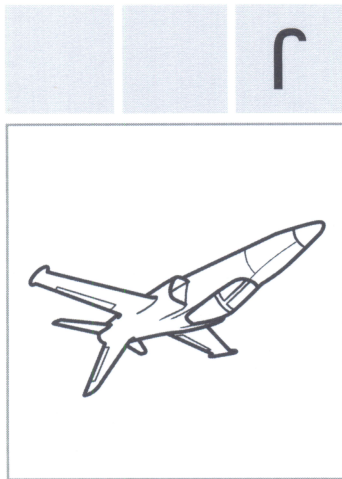
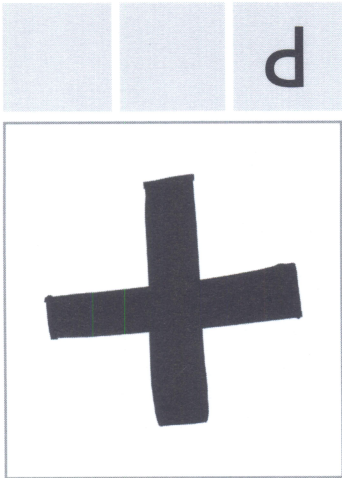

A

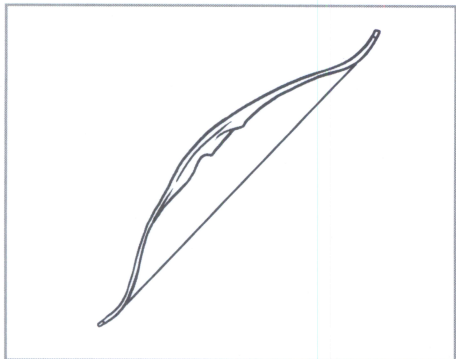

W

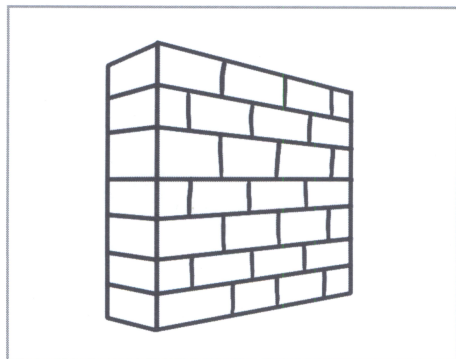

R

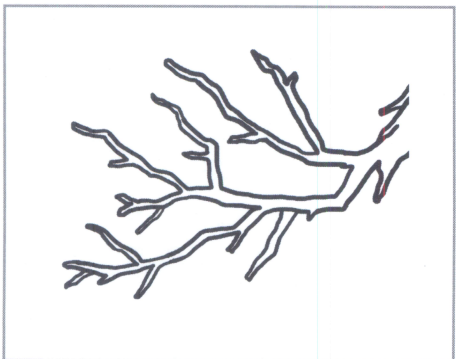

F

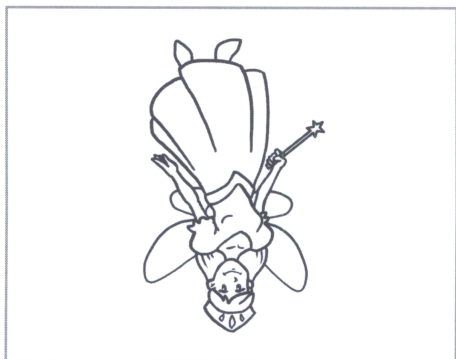

V

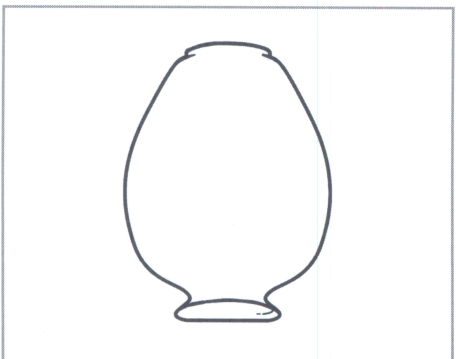

W

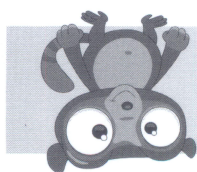
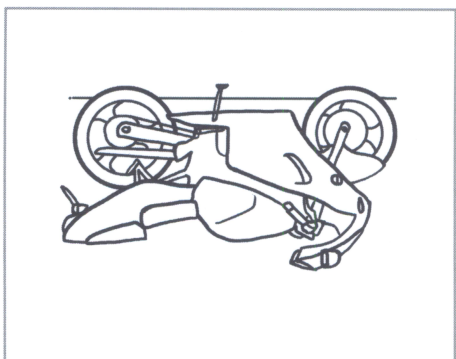

OSSERVA IL DISEGNO E COMPLETA LA PAROLA

24

SCHEDA



P

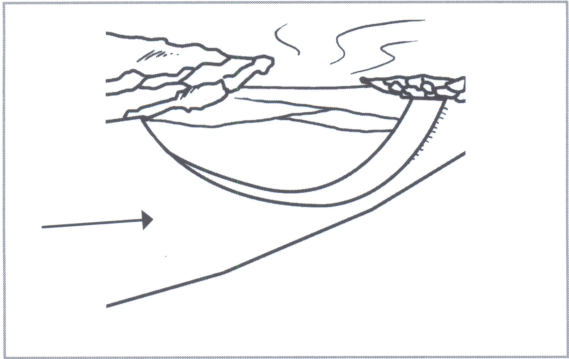

T

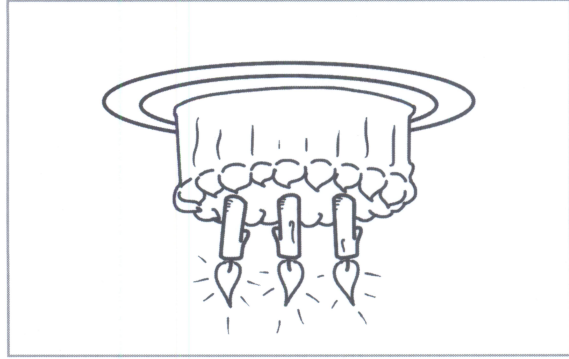

T

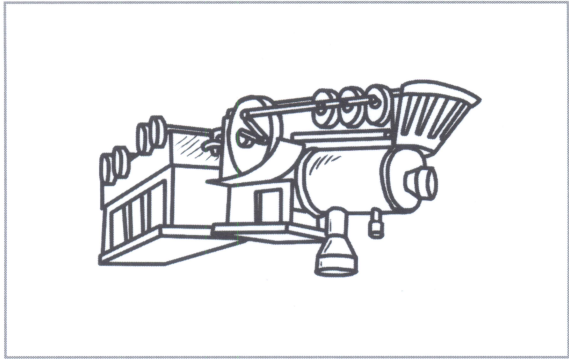

P

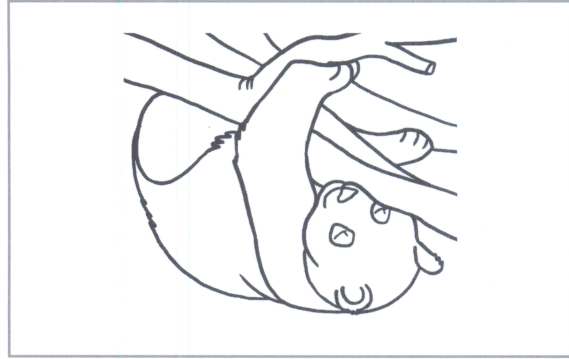

B

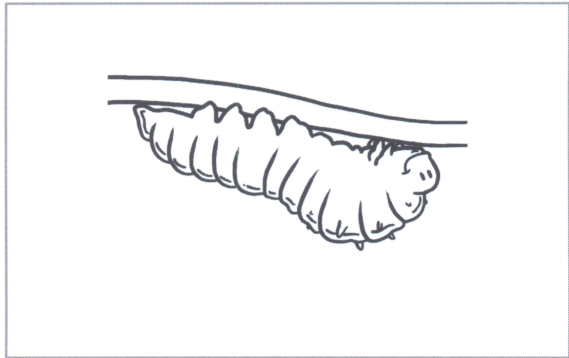

G

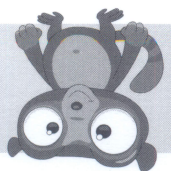



E



U



F

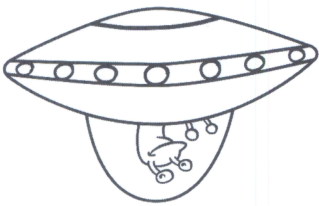

G



O



R

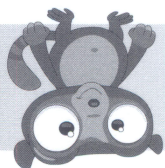
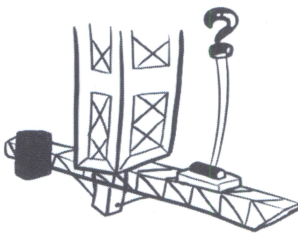

OSSERVA IL DISEGNO E COMPLETA LA PAROLA

26  
SCHEDA



R



H

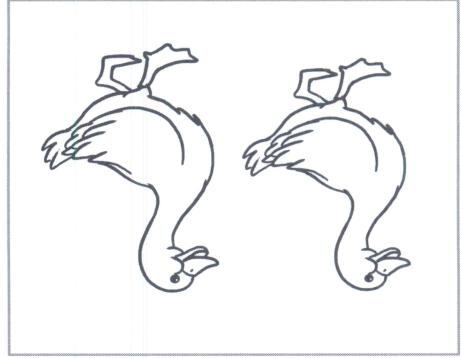

O



I

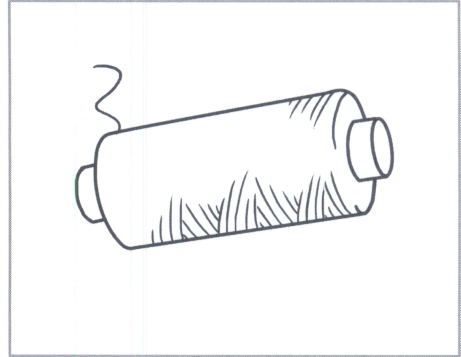

P



W

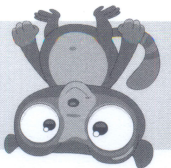
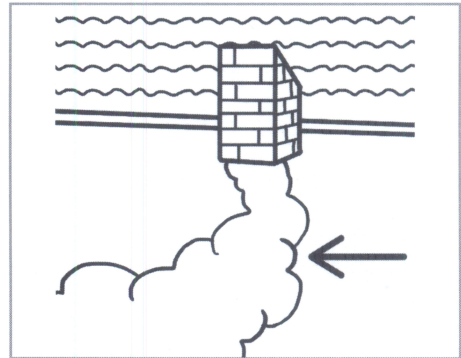



S

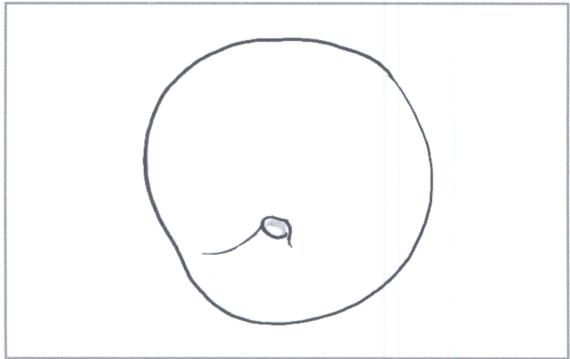

S

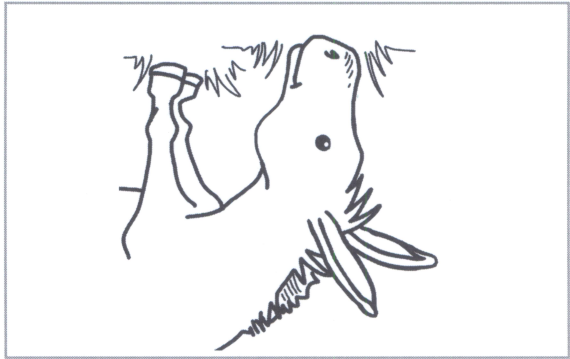

E

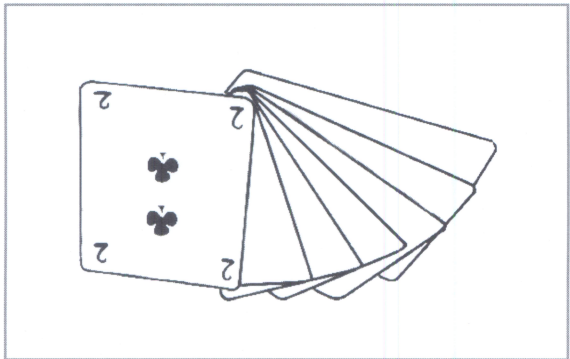

P

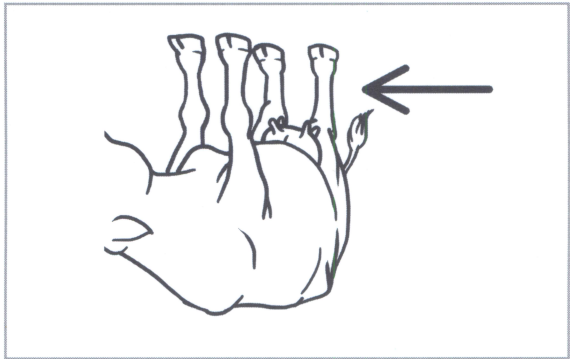

T

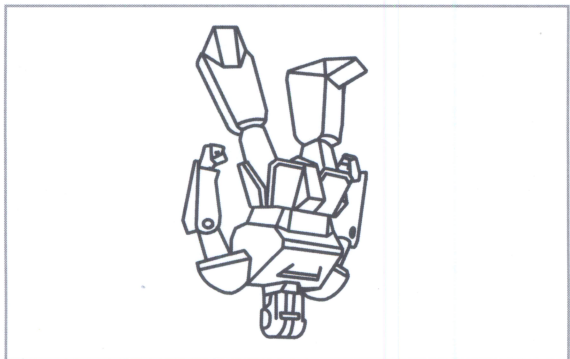

P



OSSERVA IL DISEGNO E COMPLETA LA PAROLA

28  
SCHEDA



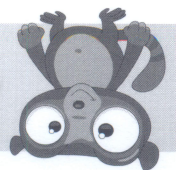
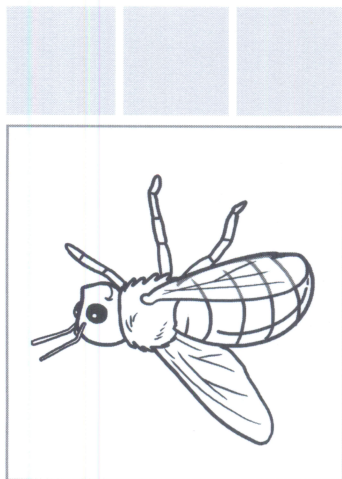
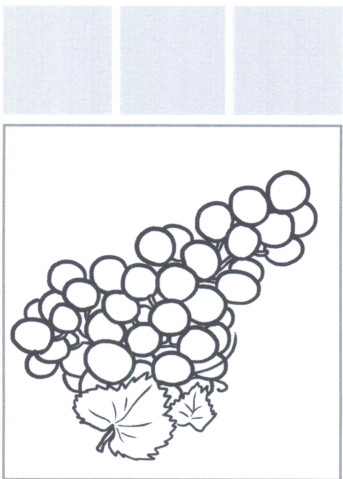
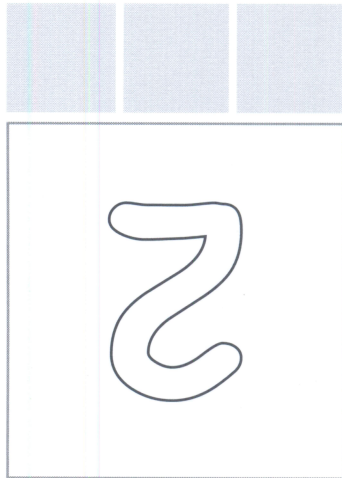
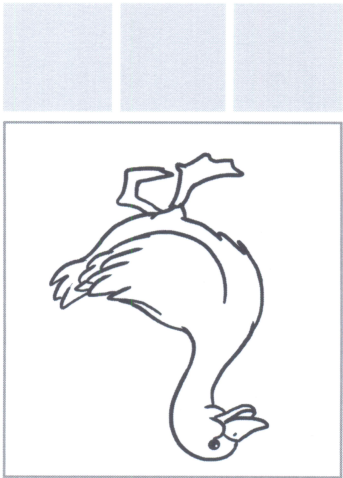
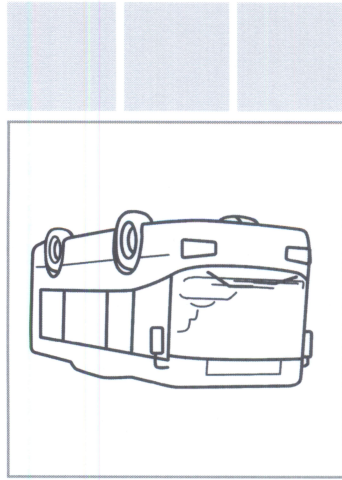
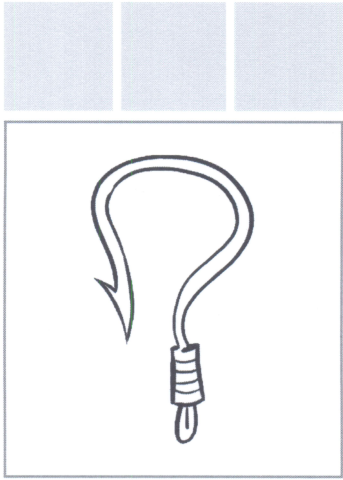

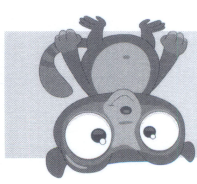
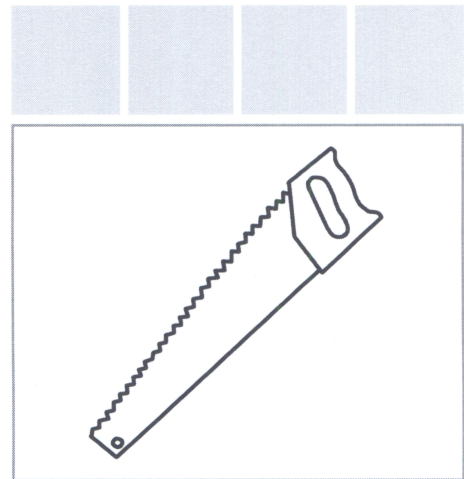
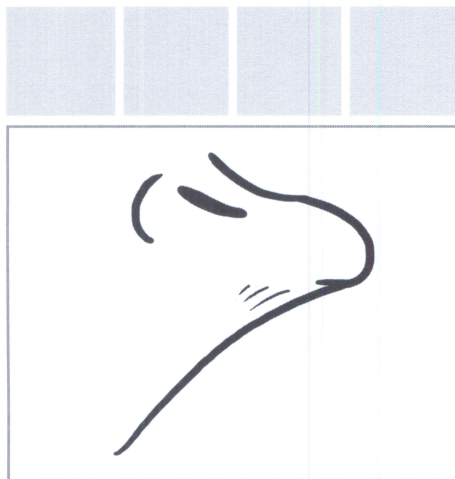
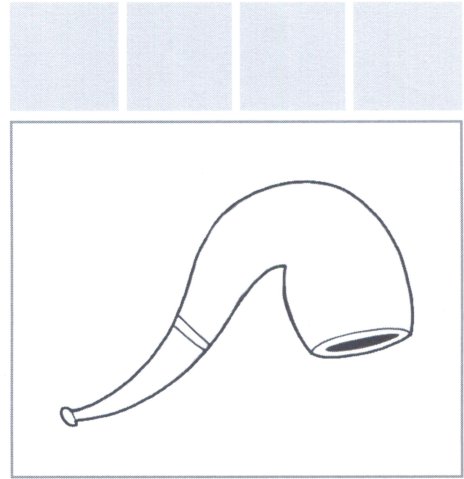
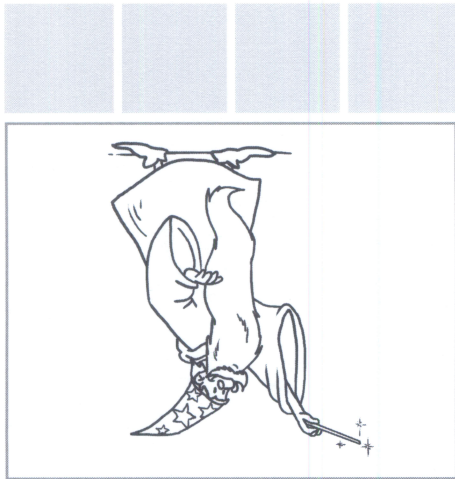
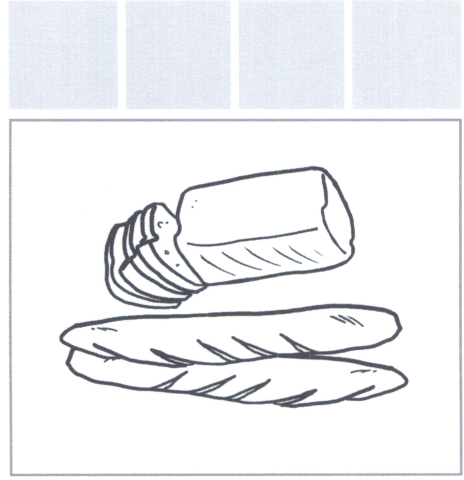
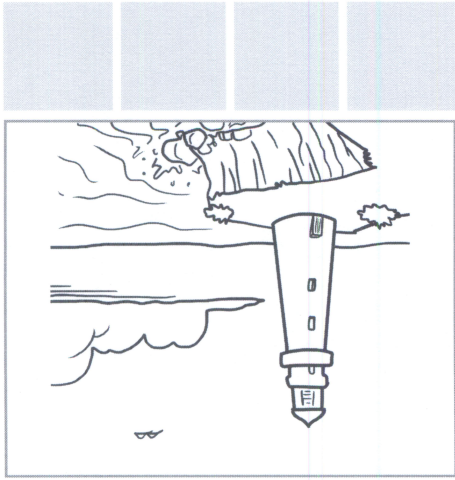

OSSERVA IL DISEGNO E SCRIVI LA PAROLA

30  
SCHEDA

