

3

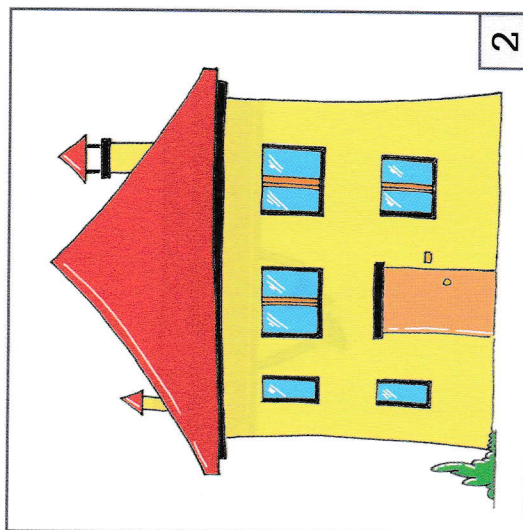

2

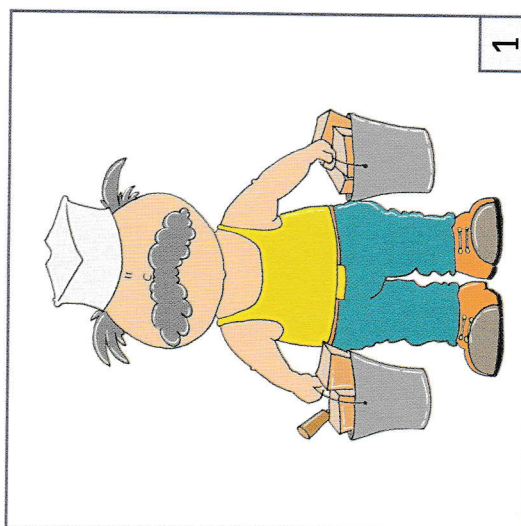

1



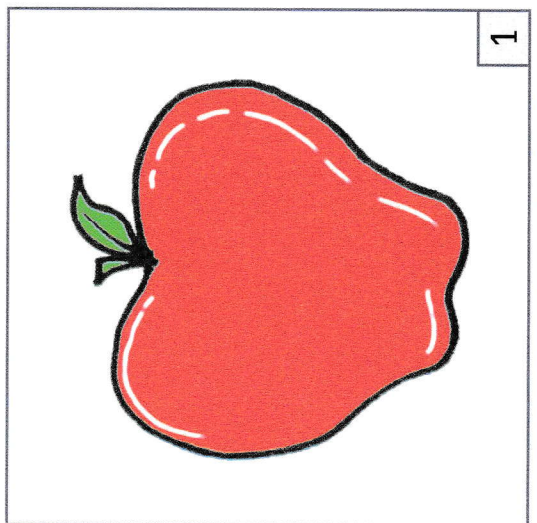
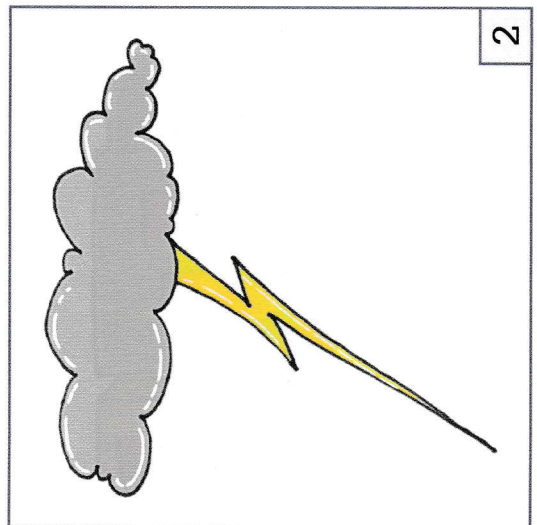
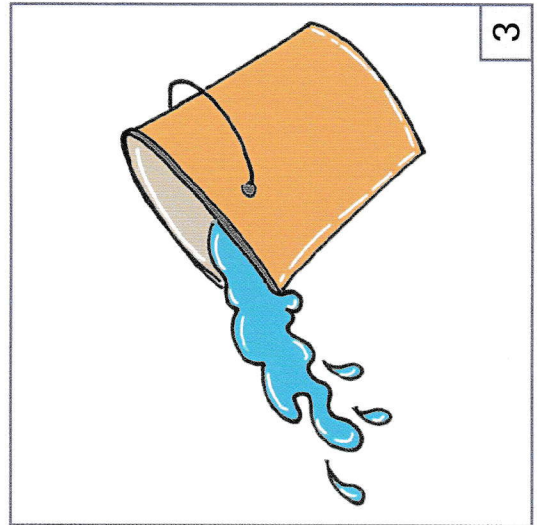
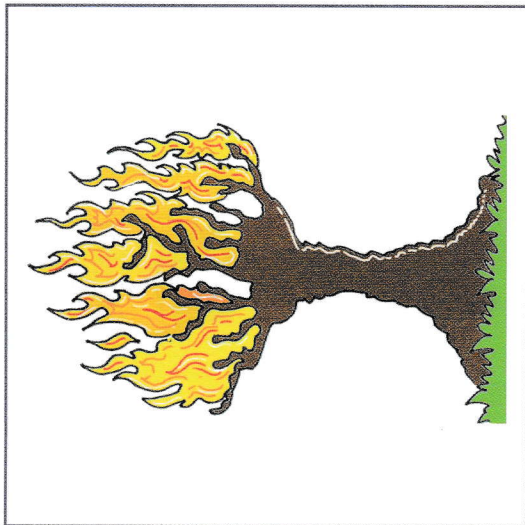

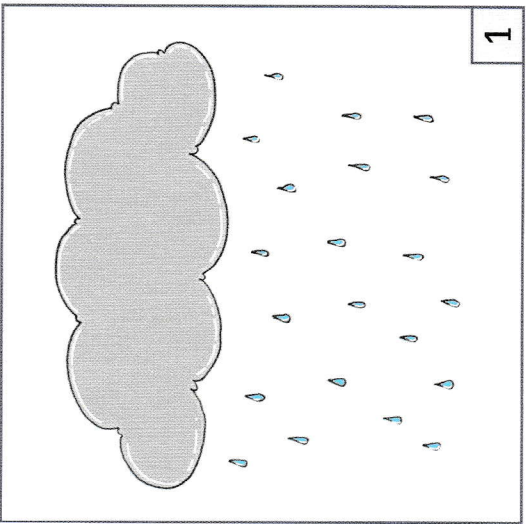
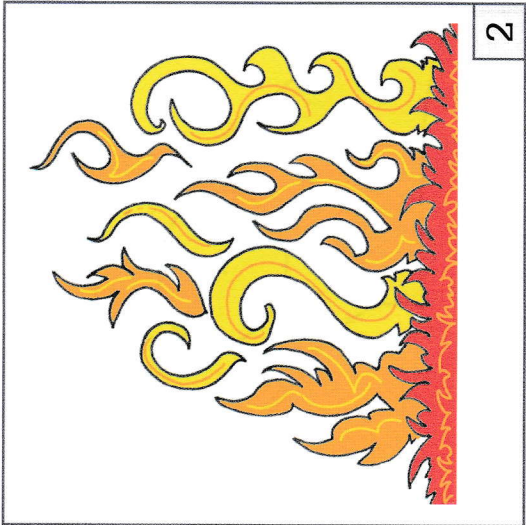
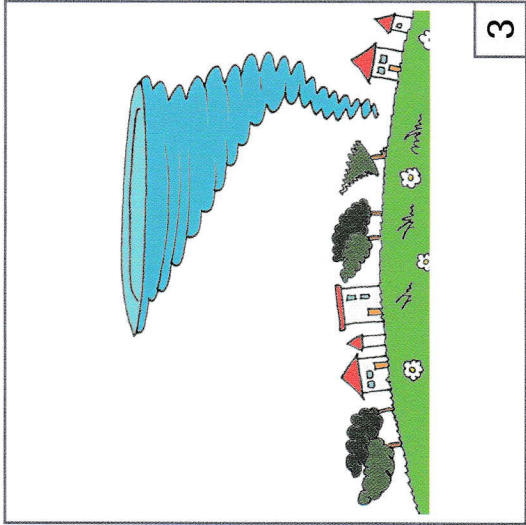
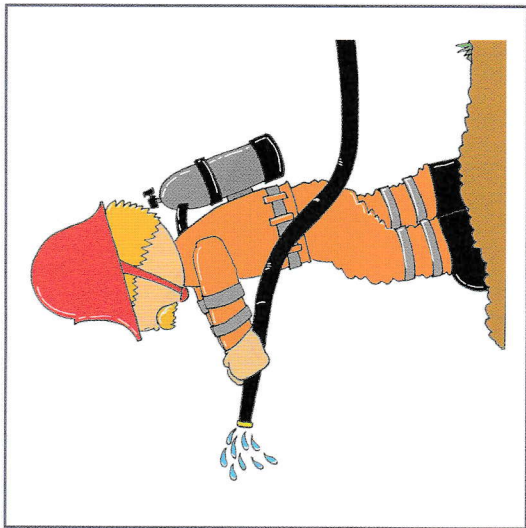



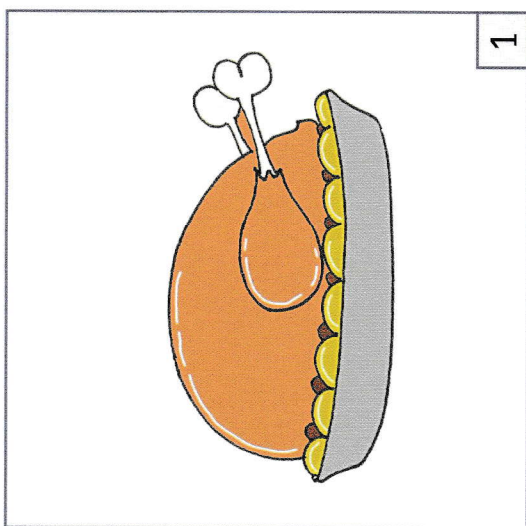
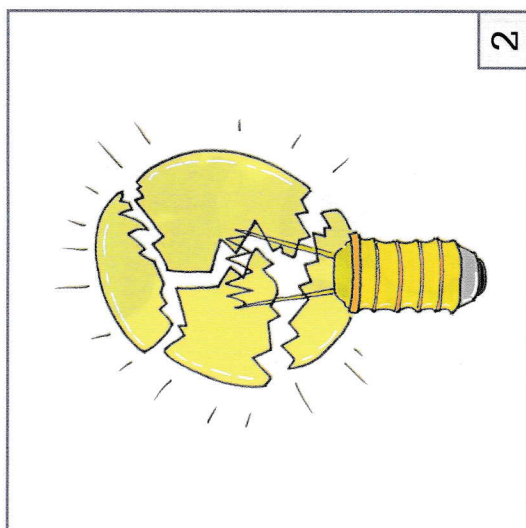
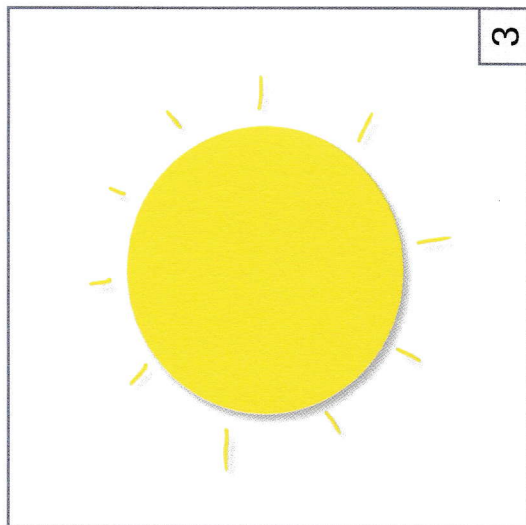
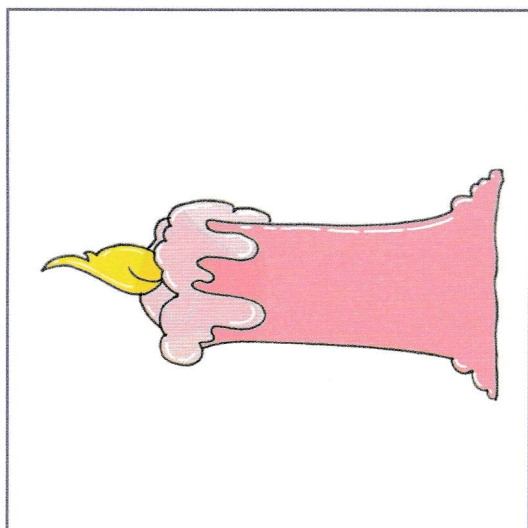

3

2

1

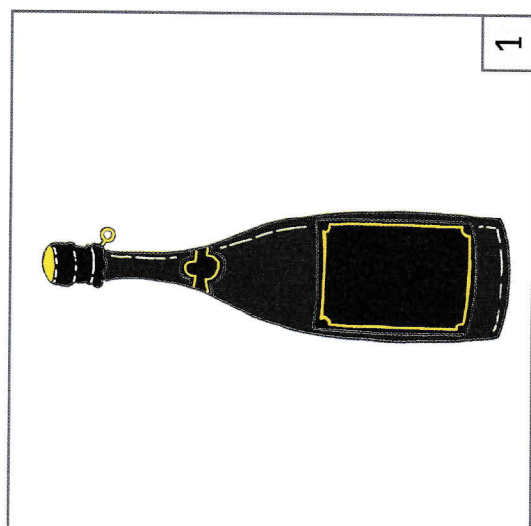
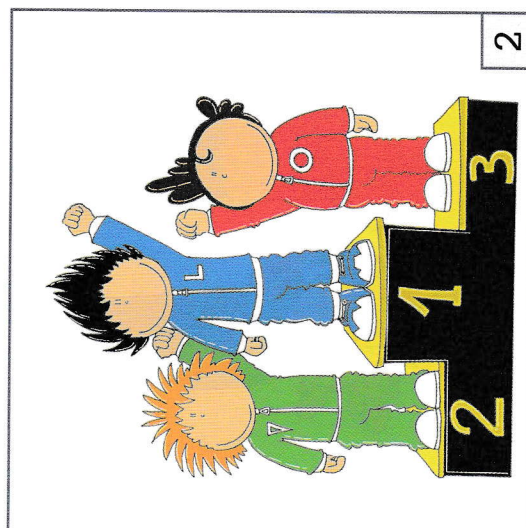
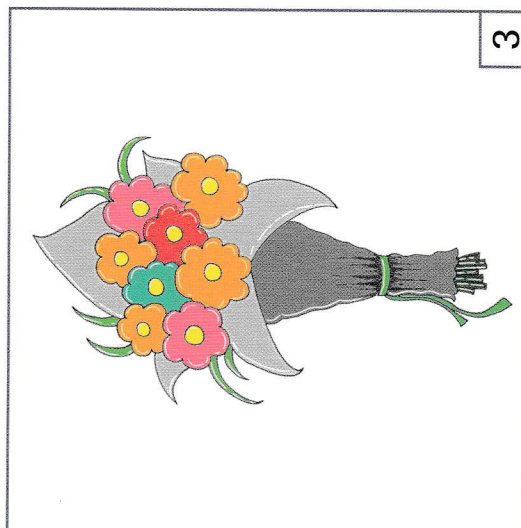
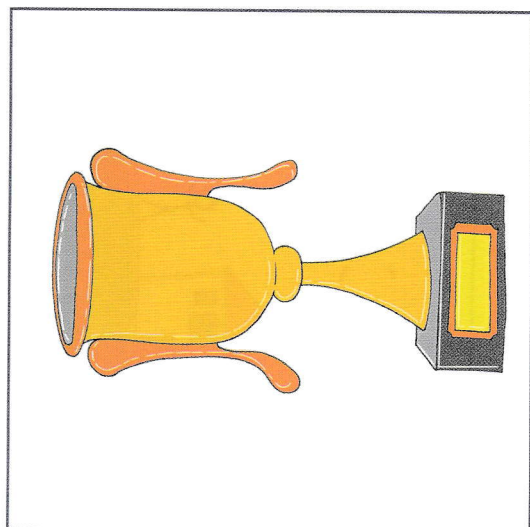

3

2

1



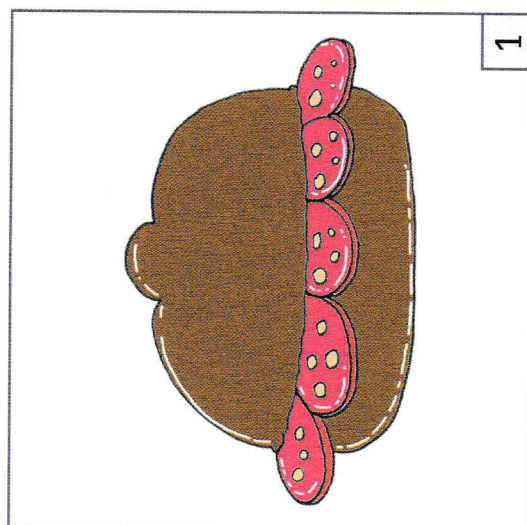
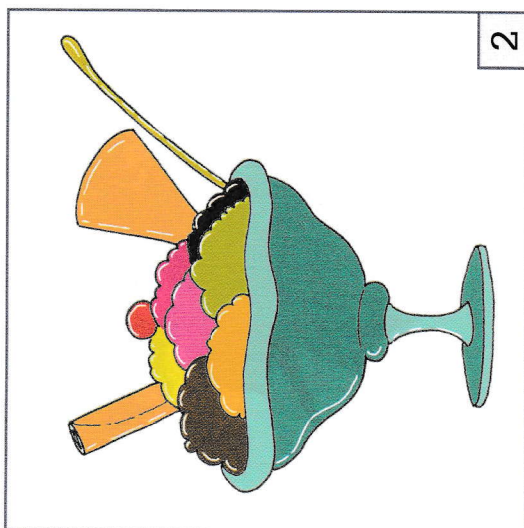
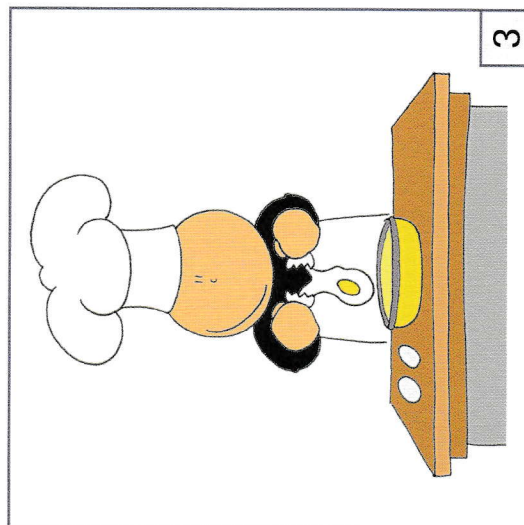
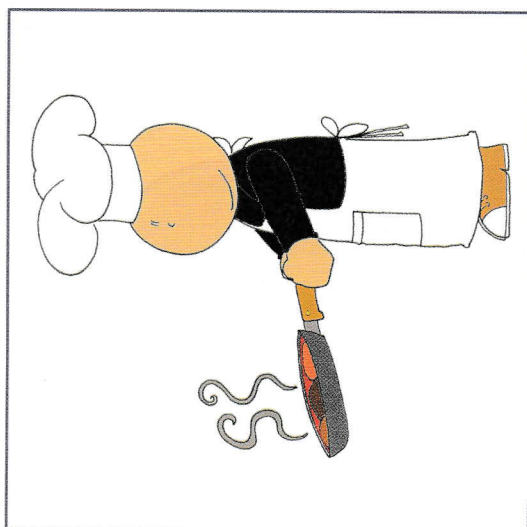

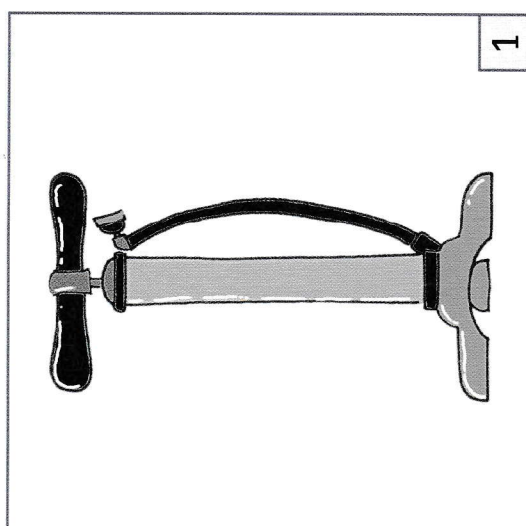
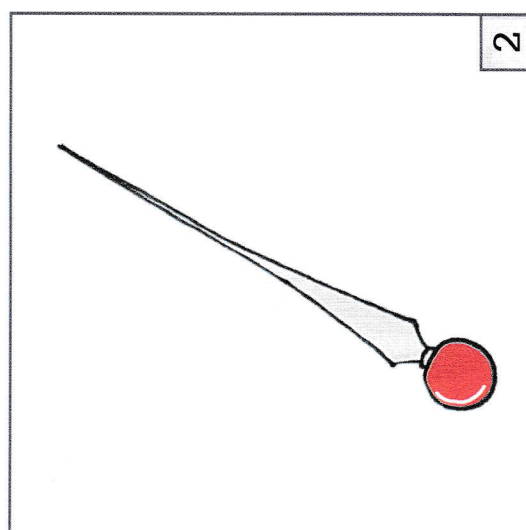
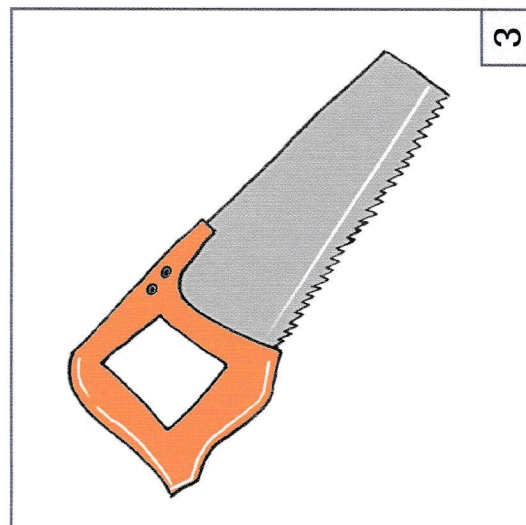
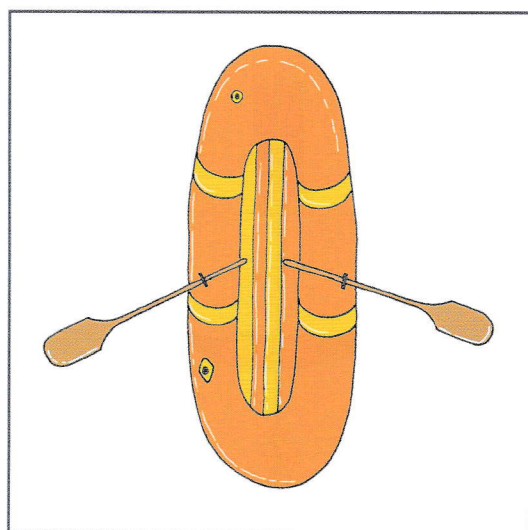



Nome e cognome	
Data di nascita	Classe/Scolarità

Osservazione comportamentale	
<input type="checkbox"/> difficoltà nella comprensione della consegna	<input type="checkbox"/> scarsa collaborazione
<input type="checkbox"/> impulsività nel fornire le risposte	<input type="checkbox"/> difficoltà nel motivare la propria scelta
<input type="checkbox"/> scarsa attenzione	<input type="checkbox"/> difficoltà di linguaggio in produzione
	<input type="checkbox"/> tendenza all'affaticamento
	<input type="checkbox"/> necessari continue sollecitazioni e rinforzi
	<input type="checkbox"/> marcata inibizione emotiva

Item	Risposta	Punti	Tempo di esecuzione	Osservazione comportamentale
1	1 2 3			
2	1 2 3			
3	1 2 3			
4	1 2 3			
5	1 2 3			
6	1 2 3			
7	1 2 3			
8	1 2 3			
9	1 2 3			
10	1 2 3			
11	1 2 3			
12	1 2 3			
13	1 2 3			

Item	Risposta	Punti	Tempo di esecuzione	Osservazione comportamentale
33	1 2 3			
34	1 2 3			
35	1 2 3			
36	1 2 3			
37	1 2 3			
38	1 2 3			
39	1 2 3			
40	1 2 3			
41	1 2 3			
42	1 2 3			
43	1 2 3			
44	1 2 3			
45	1 2 3			
46	1 2 3			
47	1 2 3			
48	1 2 3			
49	1 2 3			