

3

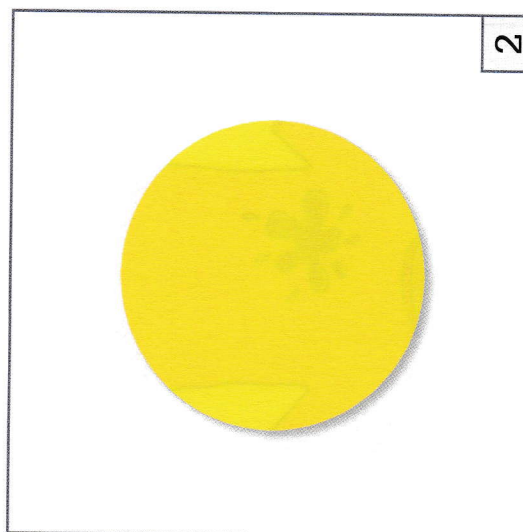

2

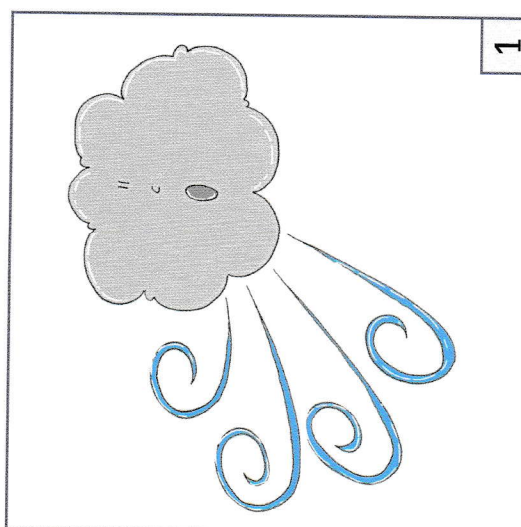

1

The large frame contains the following elements:

- Box 1:** A mallet with a black head and a wooden handle.
- Box 2:** A hand saw with an orange handle and a grey blade.
- Box 3:** A pair of scissors with orange handles and silver blades.
- Center:** An illustration of a hammer with a silver head and a wooden handle, positioned on top of a rectangular wooden block.

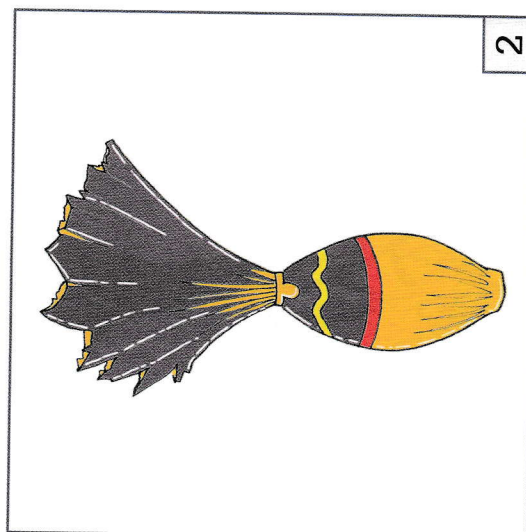
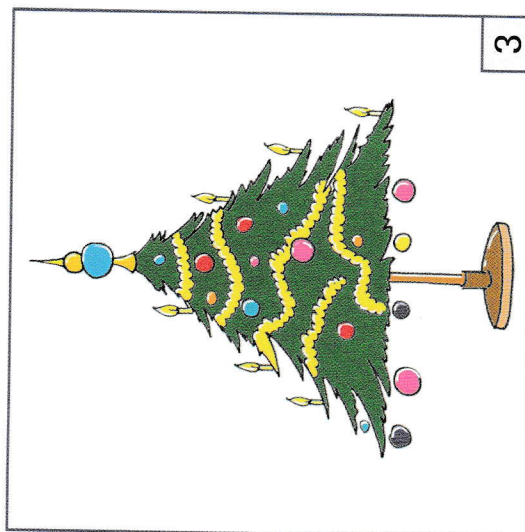
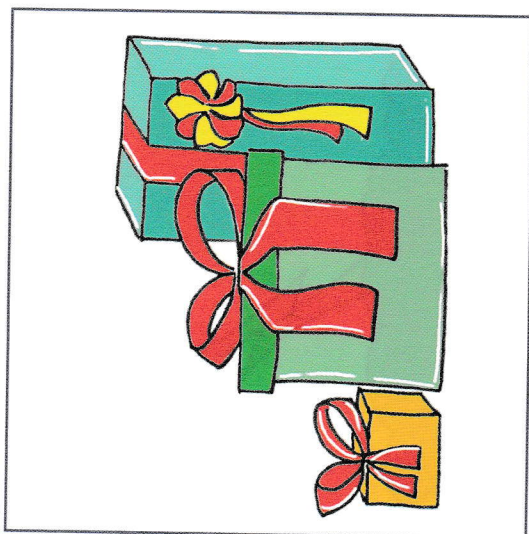

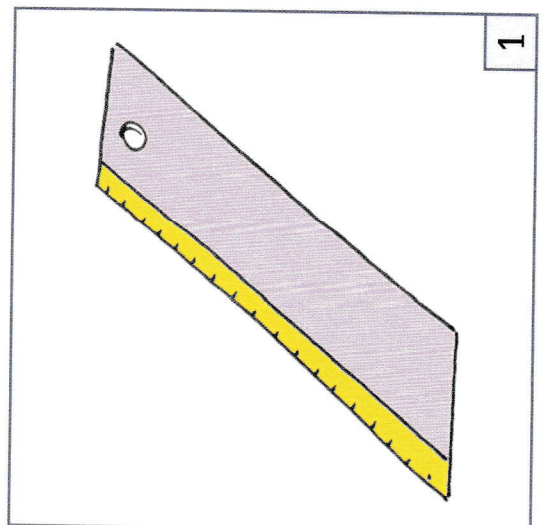
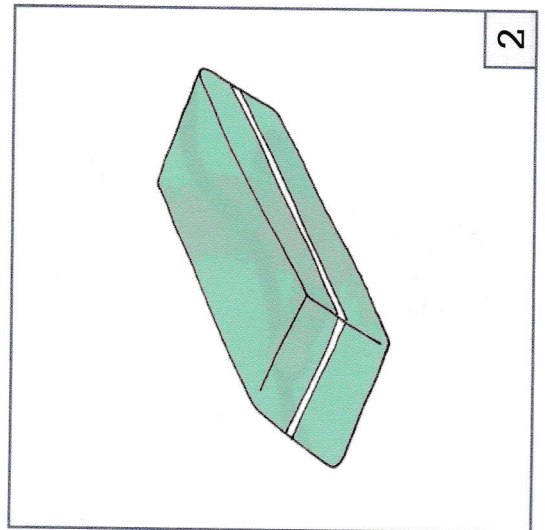
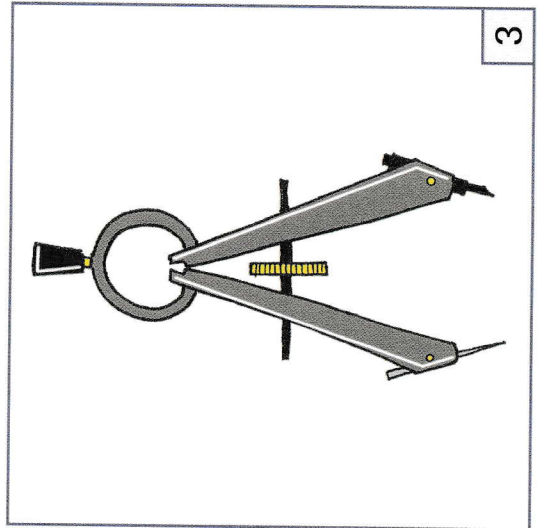
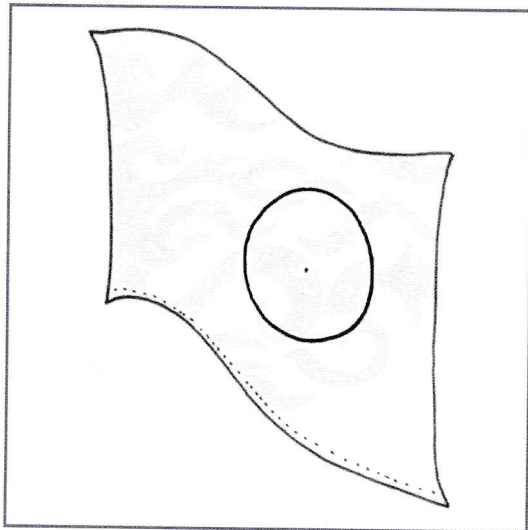

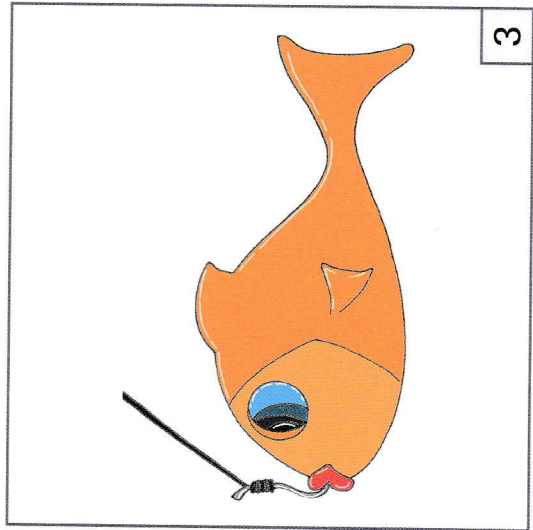
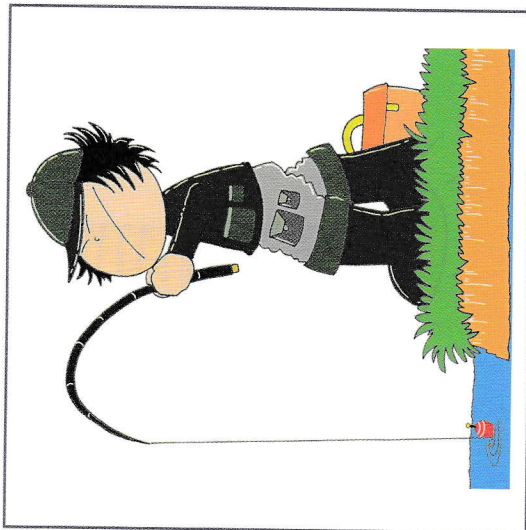

3

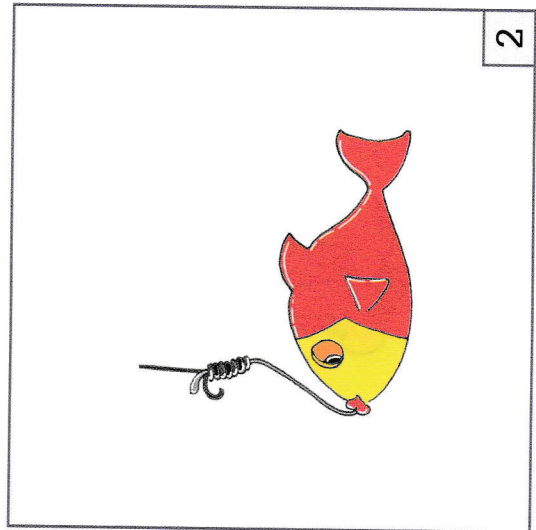

2

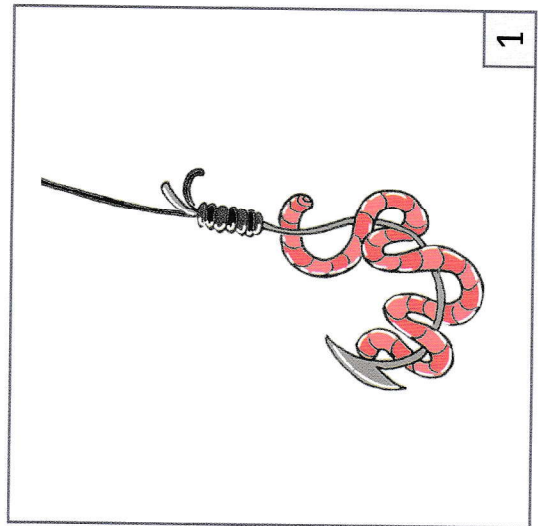

1

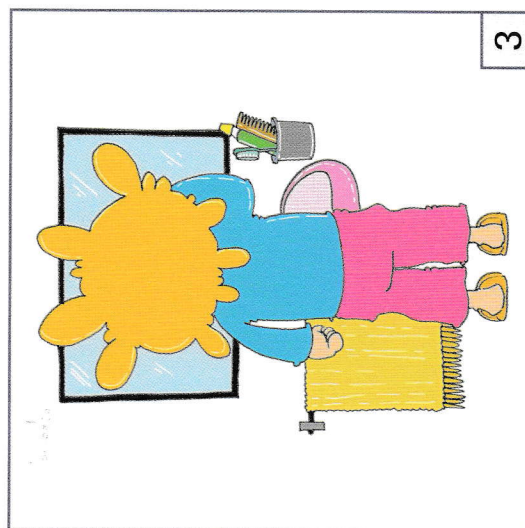

3

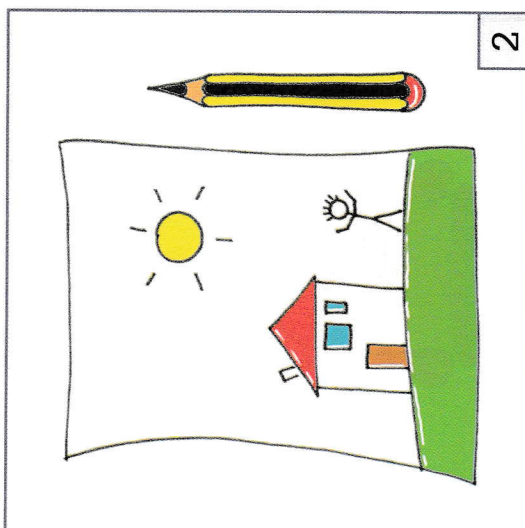

2



1

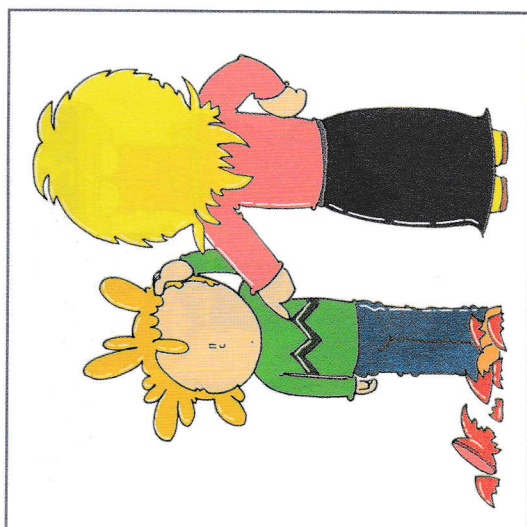

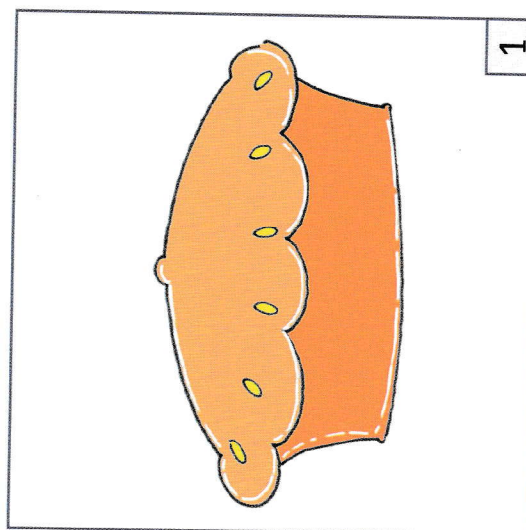
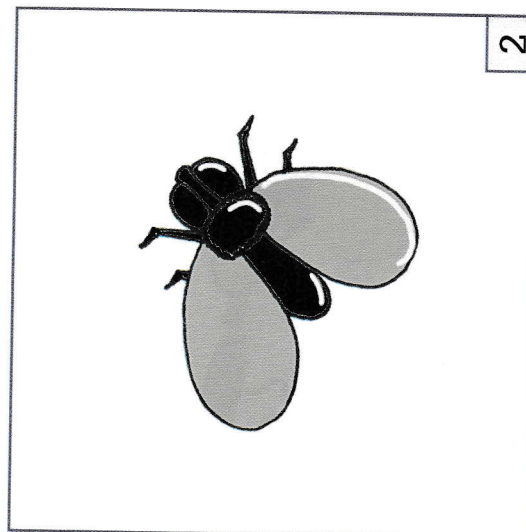
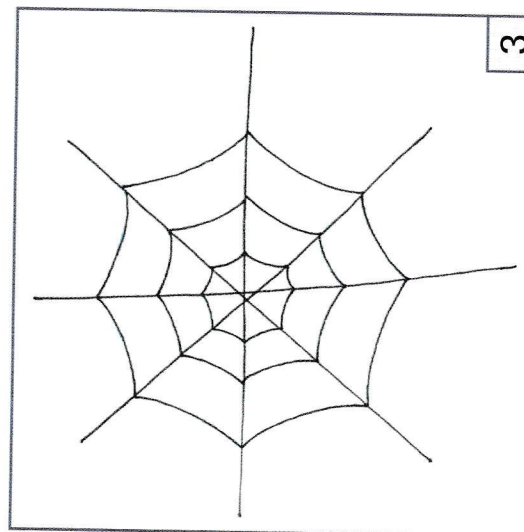
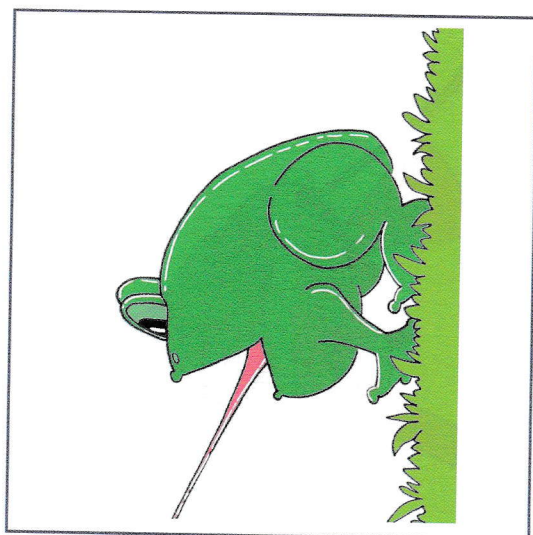

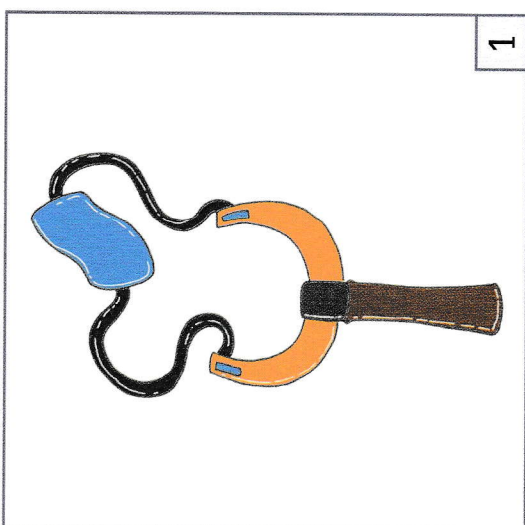
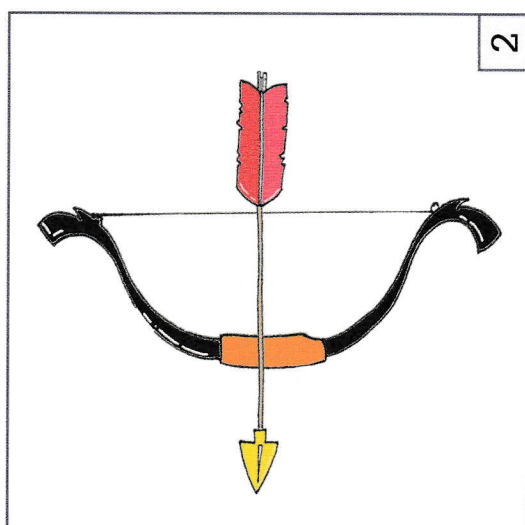
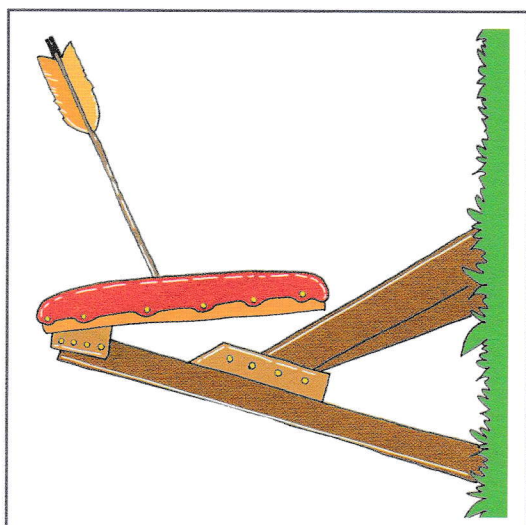

3

2

1



Item	Risposta	Punti	Tempo di esecuzione	Osservazione comportamentale
14	1 2 3			
15	1 2 3			
16	1 2 3			
17	1 2 3			
18	1 2 3			
19	1 2 3			
20	1 2 3			
21	1 2 3			
22	1 2 3			
23	1 2 3			
24	1 2 3			
25	1 2 3			
26	1 2 3			
27	1 2 3			
28	1 2 3			
29	1 2 3			
30	1 2 3			
31	1 2 3			
32	1 2 3			

Item	Risposta	Punti	Tempo di esecuzione	Osservazione comportamentale
50	1 2 3			
51	1 2 3			
<b>Totale</b>				

Note

---

---

---

---

---

---

---

---

---

---

---

---

---

---

---

---

---

---

---

---

---

---

---

---

---

---

---

---

---

---