

Seriazioni di immagini concrete



Abilità coinvolte

- Attenzione e analisi visiva
- Capacità logico-deduttive e di ordinamento seriale di oggetti secondo specifici criteri definiti da modelli preesistenti







Istruzioni per la somministrazione



L'operatore mostra al soggetto la sequenza di immagini nella parte superiore del foglio, indicando ognuna di esse e soffermandosi con il dito per un secondo su ciascuna immagine. Dopodiché mostra la/le casella/e vuota/e e invita il soggetto a scegliere, fra le opzioni poste nella parte inferiore del foglio, la/le immagine/i necessaria/e al completamento della sequenza.

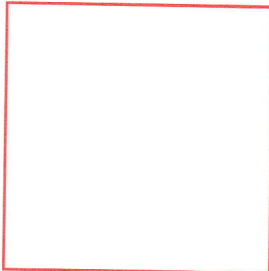

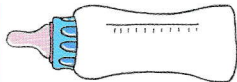
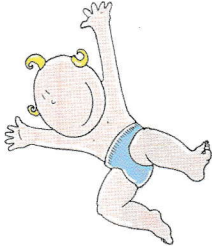
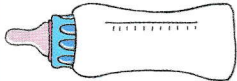
Esempi di consegne

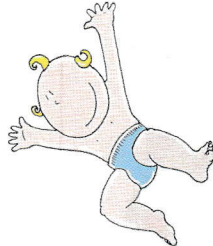

«Osserva attentamente questa sequenza di immagini [l'operatore indica le immagini poste all'interno delle caselle per un secondo ciascuna]. In questa casella ne manca una/In queste caselle ne mancano due [l'operatore indica la/le casella/e vuota/e soffermandosi su di essa/e per tre secondi]. Dovrai scegliere fra queste immagini in basso [l'operatore indica le immagini poste nella parte inferiore del foglio] quella che va inserita nell'apposito spazio [l'operatore indica nuovamente la/le casella/e vuota/e nella parte superiore del foglio] per completare la sequenza.»

	<p>B</p>
	<p>A</p>





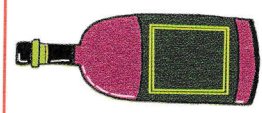
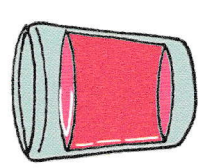
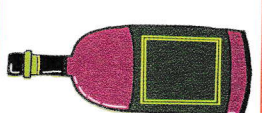

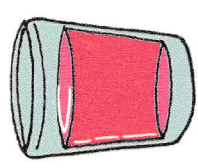
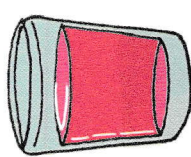
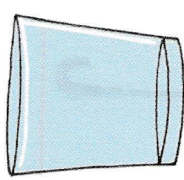
PROBLEM SOLVING

Area 5 - Seriazioni di immagini concrete

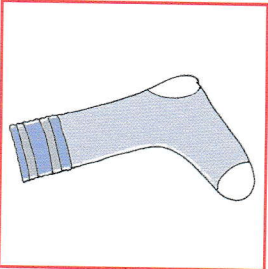

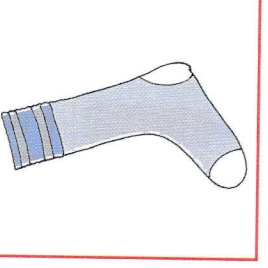
<div style="display: flex; justify-content: space-around; align-items: center;"> <div style="border: 1px solid red; padding: 5px; margin: 5px;"></div> <div style="border: 1px solid red; padding: 5px; margin: 5px;"></div> <div style="border: 1px solid red; padding: 5px; margin: 5px;"></div> <div style="border: 1px solid red; padding: 5px; margin: 5px;"></div> <div style="border: 1px solid red; padding: 5px; margin: 5px;"></div> <div style="border: 1px solid red; padding: 5px; margin: 5px;"></div> </div>	<div style="display: flex; justify-content: space-around; align-items: center;"> <div style="border: 1px solid red; padding: 5px; margin: 5px;"></div> <div style="border: 1px solid red; padding: 5px; margin: 5px;">B</div> </div> <div style="display: flex; justify-content: space-around; align-items: center; margin-top: 20px;"> <div style="border: 1px solid red; padding: 5px; margin: 5px;"></div> <div style="border: 1px solid red; padding: 5px; margin: 5px;">A</div> </div>
--	--

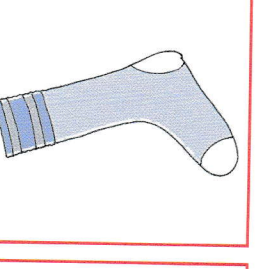

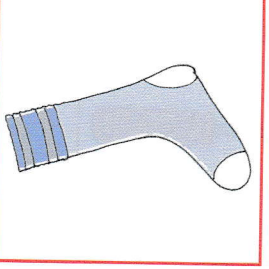

PROBLEM SOLVING

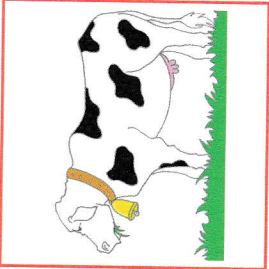
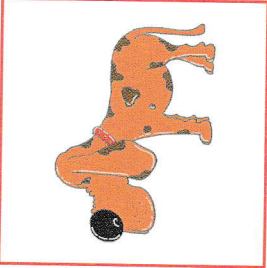
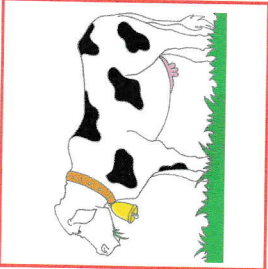
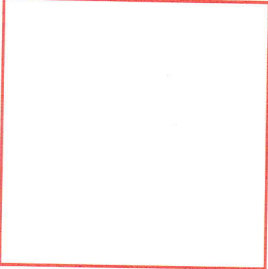
Area 5 - Seriazioni di immagini concrete

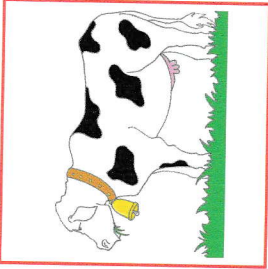
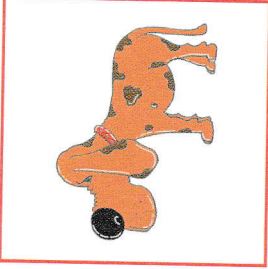

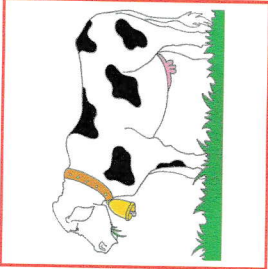
	B
	A

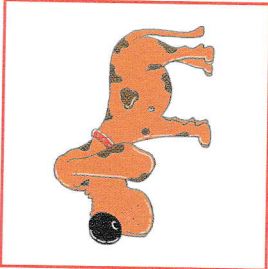





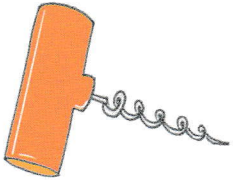
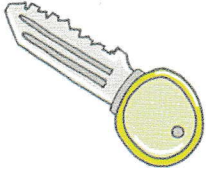
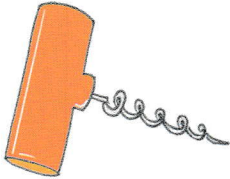
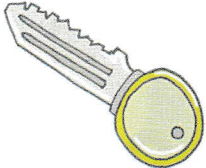
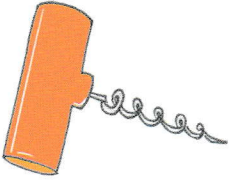
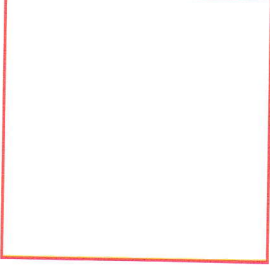

	
	

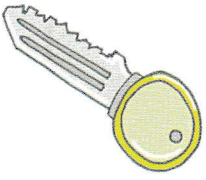
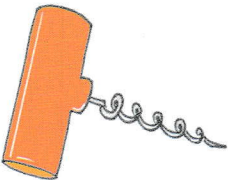

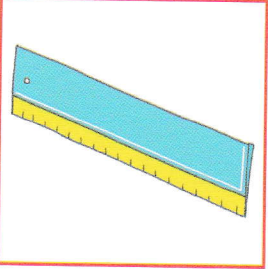

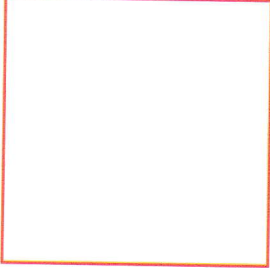
PROBLEM SOLVING

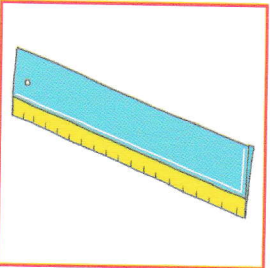
Area 5 - Seriazioni di immagini concrete









	<p>B</p>
	<p>A</p>

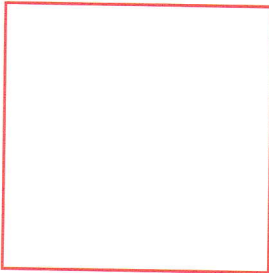

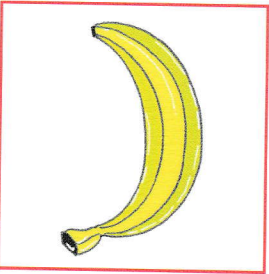
PROBLEM SOLVING

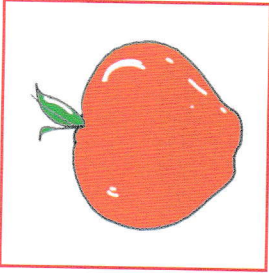
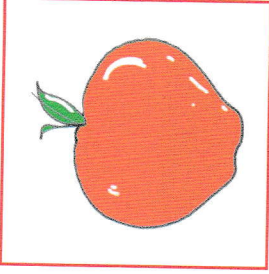
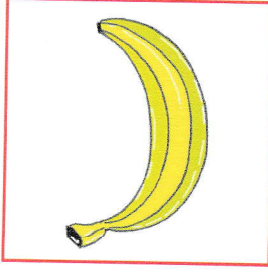
Area 5 - Seriazioni di immagini concrete

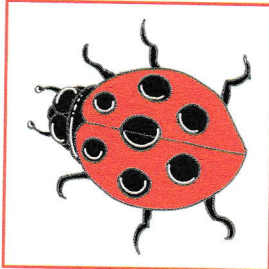
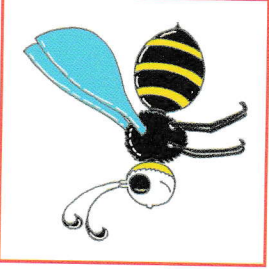
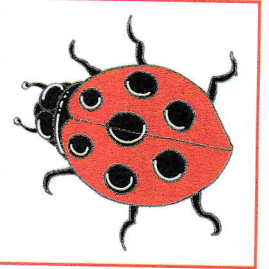
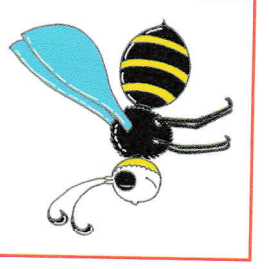
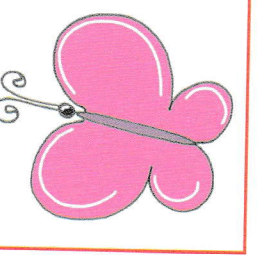
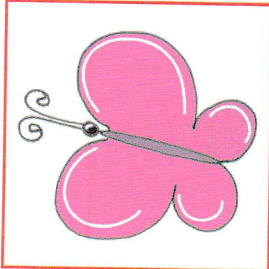

PROBLEM SOLVING

Area 5 - Seriazioni di immagini concrete

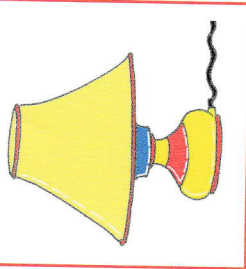
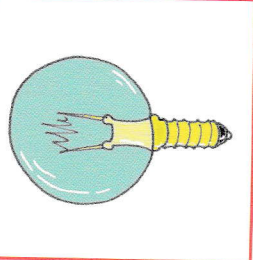
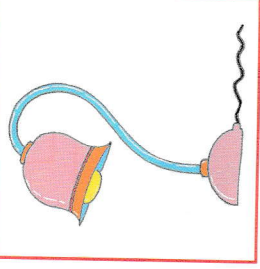
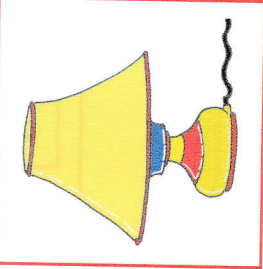
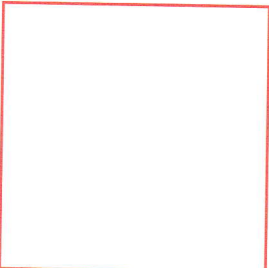
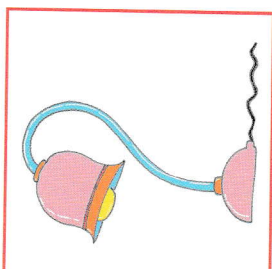

<div style="display: flex; justify-content: space-around; align-items: center;"> <div style="border: 1px solid red; padding: 5px; margin: 5px;"></div> <div style="border: 1px solid red; padding: 5px; margin: 5px;"></div> <div style="border: 1px solid red; padding: 5px; margin: 5px; width: 50px; height: 50px;"></div> <div style="border: 1px solid red; padding: 5px; margin: 5px;"></div> <div style="border: 1px solid red; padding: 5px; margin: 5px;"></div> <div style="border: 1px solid red; padding: 5px; margin: 5px;"></div> </div>	<div style="display: flex; justify-content: space-around; align-items: center; margin-top: 100px;"> <div style="border: 1px solid red; padding: 5px; margin: 5px;"></div> <div style="border: 1px solid red; padding: 5px; margin: 5px; width: 40px; height: 20px; display: flex; align-items: center; justify-content: center;">B</div> </div> <div style="display: flex; justify-content: space-around; align-items: center; margin-top: 100px;"> <div style="border: 1px solid red; padding: 5px; margin: 5px;"></div> <div style="border: 1px solid red; padding: 5px; margin: 5px; width: 40px; height: 20px; display: flex; align-items: center; justify-content: center;">A</div> </div>
---	--

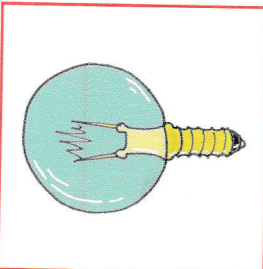
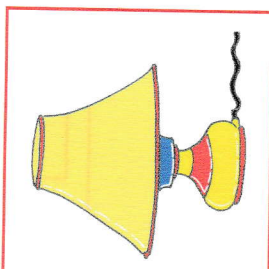



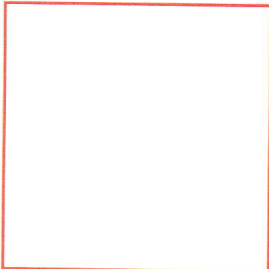

	
<div style="border: 1px solid black; padding: 2px; display: inline-block;">A</div>	<div style="border: 1px solid black; padding: 2px; display: inline-block;">B</div>

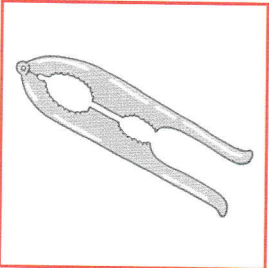
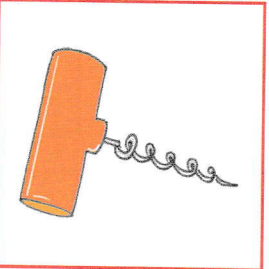
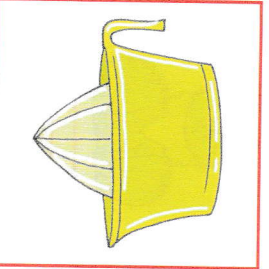
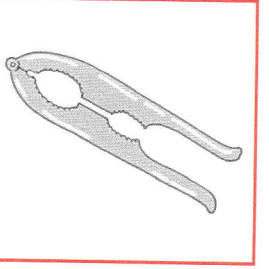
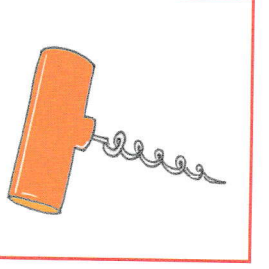
PROBLEM SOLVING

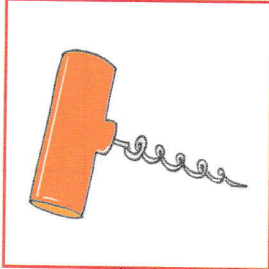
Area 5 - Seriazioni di immagini concrete

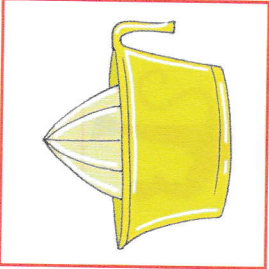



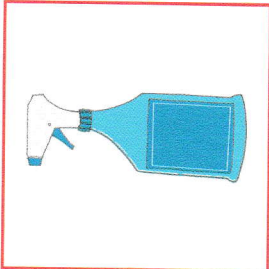
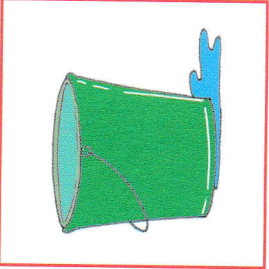
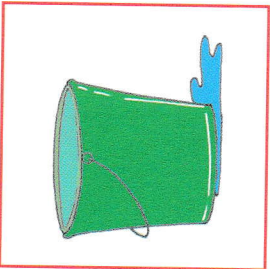
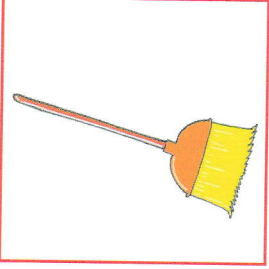

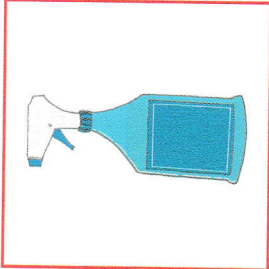
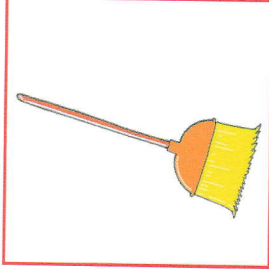

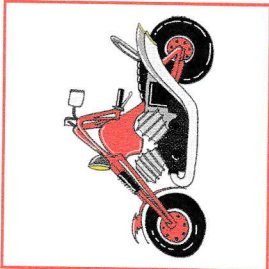

	
	
	<input type="checkbox"/>
	<input type="checkbox"/>
	
	

	<input type="checkbox"/> B
	<input type="checkbox"/> A

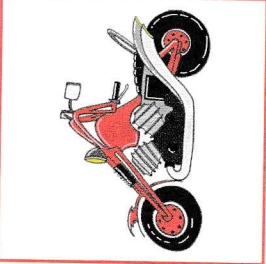
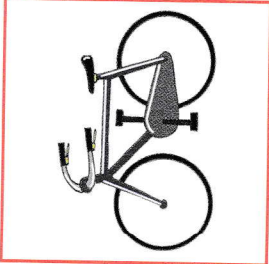
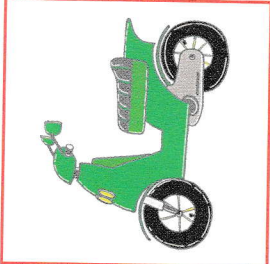
PROBLEM SOLVING

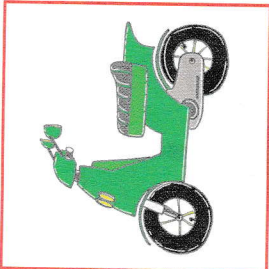

Area 5 - Seriazioni di immagini concrete



		
		
		
		
		
		

	
	

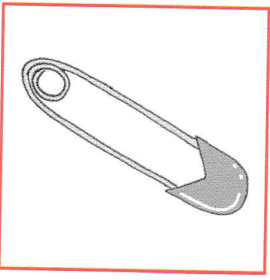
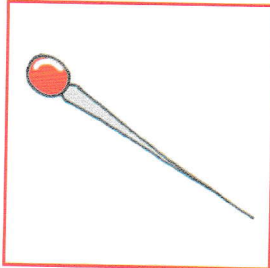
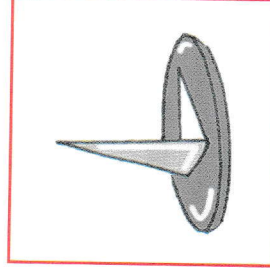
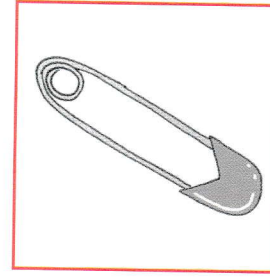
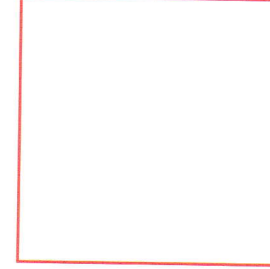
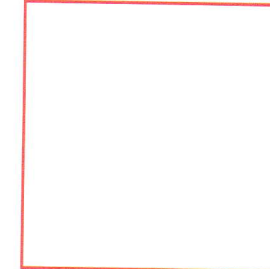

PROBLEM SOLVING

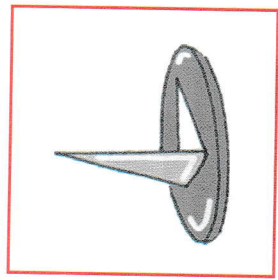
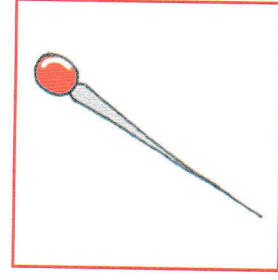
Area 5 - Seriazioni di immagini concrete



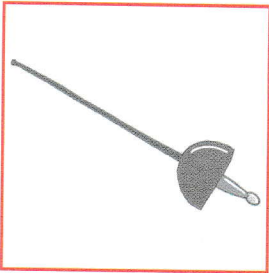
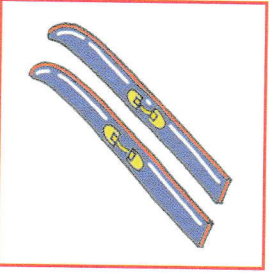
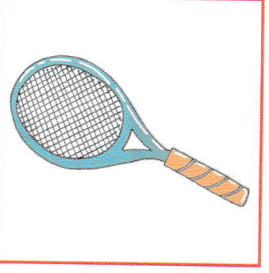
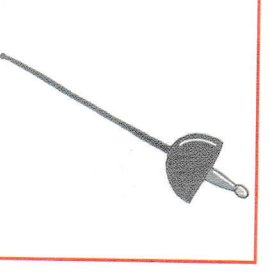

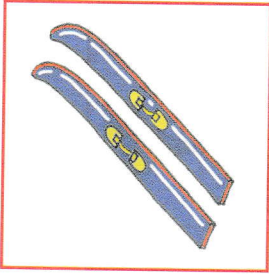

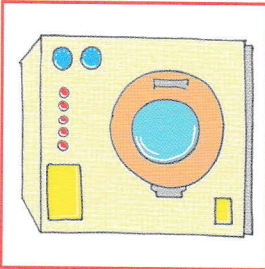
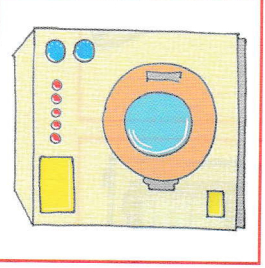
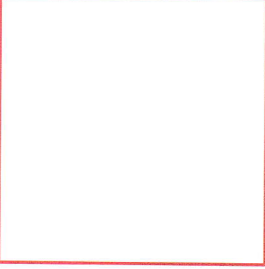

	
	
	
	
<input data-bbox="315 1402 581 1675" type="text"/>	<input data-bbox="602 1496 675 1579" type="text"/>
<input data-bbox="315 1682 581 1955" type="text"/>	<input data-bbox="602 1776 675 1859" type="text"/>

	<input data-bbox="1244 936 1318 1019" type="text"/>
	<input data-bbox="1244 1225 1318 1308" type="text"/>

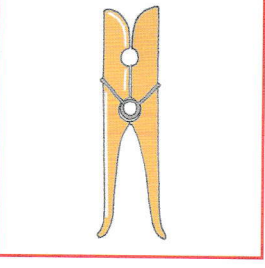
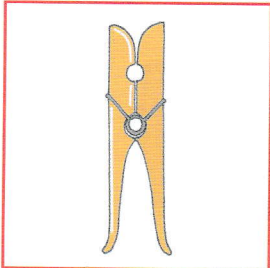
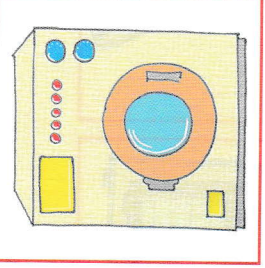
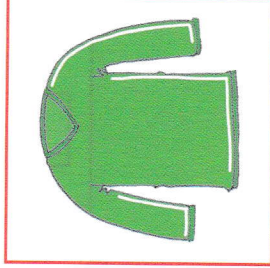
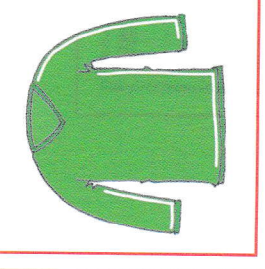
PROBLEM SOLVING

Area 5 - Seriazioni di immagini concrete

PROBLEM SOLVING



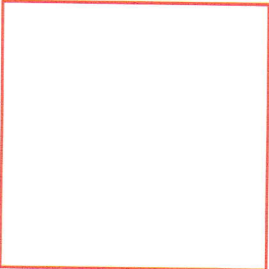
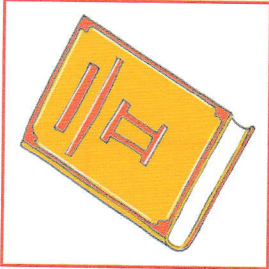
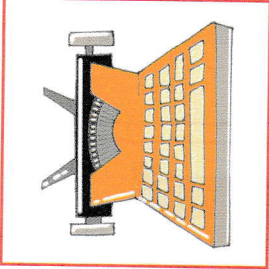
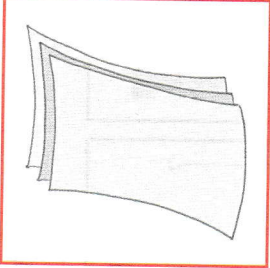
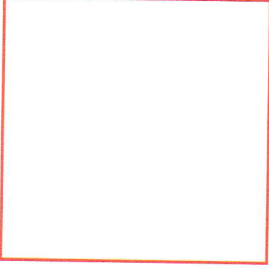
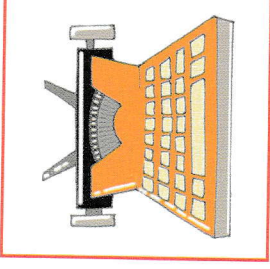

Area 5 - Seriazioni di immagini concrete

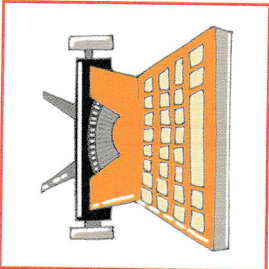
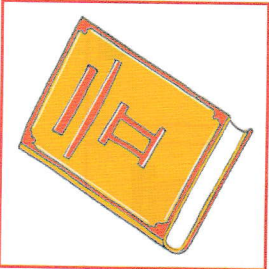
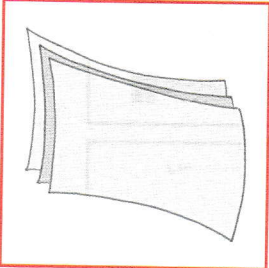



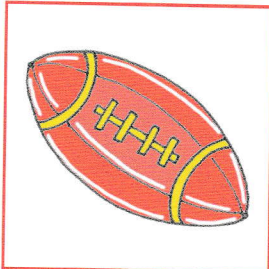
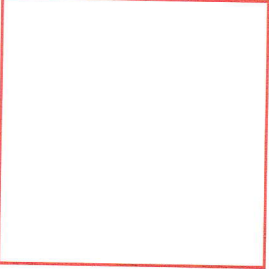

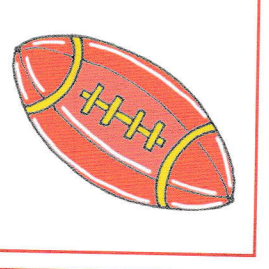
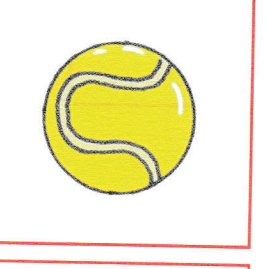
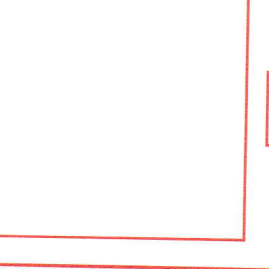
	<input data-bbox="617 360 691 439" type="checkbox"/>
	
	
	
	<input data-bbox="602 1507 675 1585" type="checkbox"/>
	

	<input data-bbox="1248 797 1321 875" type="checkbox"/>
	<input data-bbox="1244 1084 1318 1162" type="checkbox"/>
	<input data-bbox="1241 1377 1315 1456" type="checkbox"/>

PROBLEM SOLVING

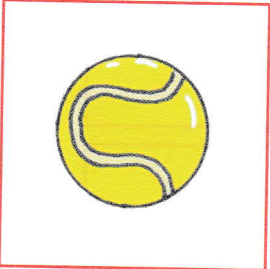

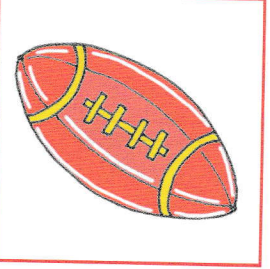
Area 5 - Seriazioni di immagini concrete

		
		
		
		
		
		





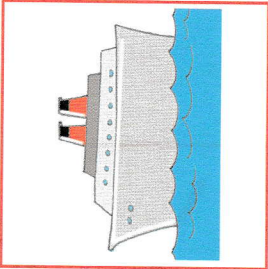

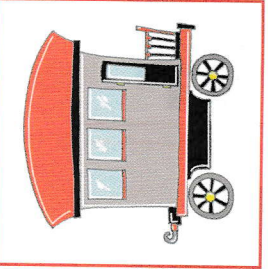
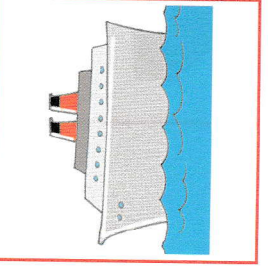

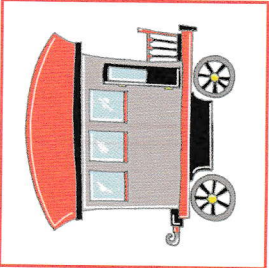
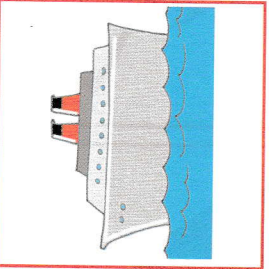
PROBLEM SOLVING

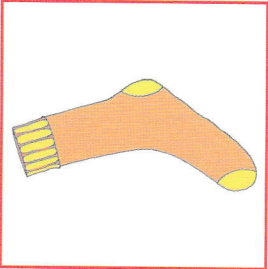
Area 5 - Seriazioni di immagini concrete



	C
	B
	A

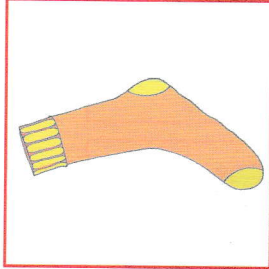

	C
	B
	A

PROBLEM SOLVING

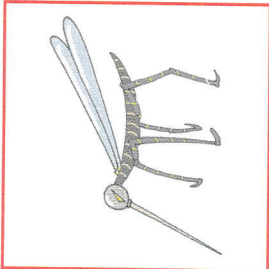
Area 5 - Seriazioni di immagini concrete

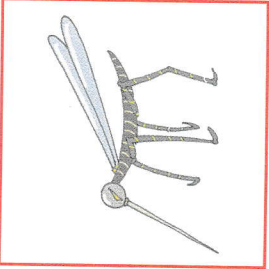
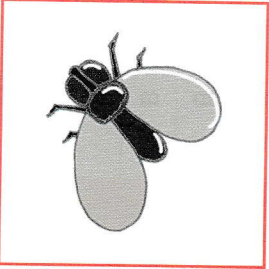
					
					
		<input type="checkbox"/>			
					
		<input type="checkbox"/>			
					

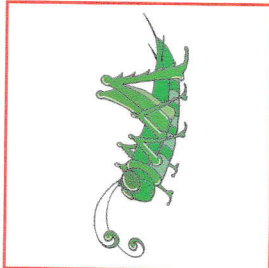
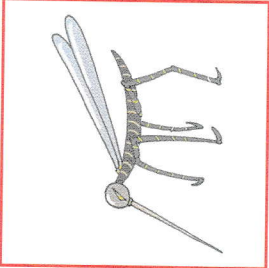
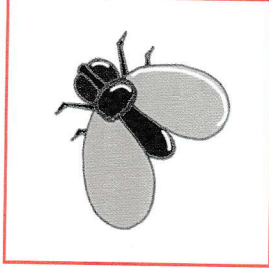
	C
	B
	A

Item	Risposta	Punti	Tempo di esecuzione	Osservazione comportamentale
17	A			
18	A			
19	B			
20	A			
21	B A			
22	B A			
23	B A			
24	B A			
25	A B			
26	B A			
27	B A			
28	A B			
29	B A			
30	A B			
31	B A			
32	B A			
33	A B			
34	C B			
35	C A			
36	C B			
37	B A			
38	A C			