

ape

epa

abe

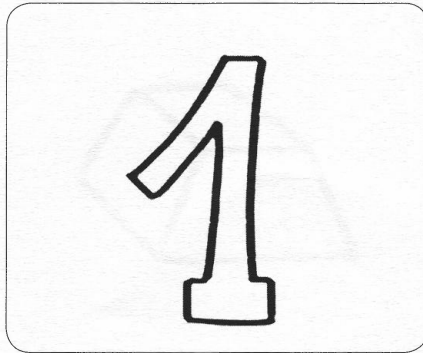

umo

uvo

uno

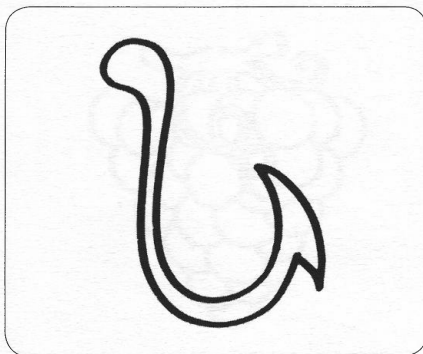

emo

amo

amu

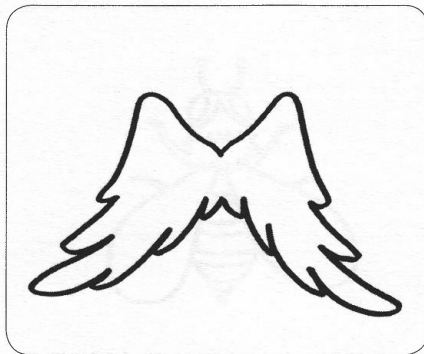

ali

eli

lai

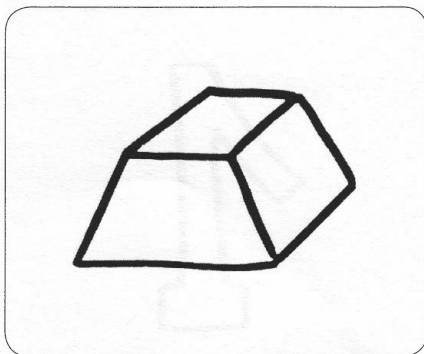

oto

oro

oru

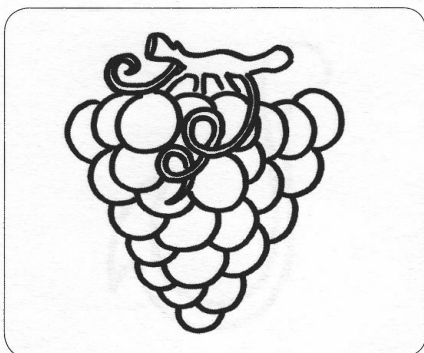

ufa

ova

uva



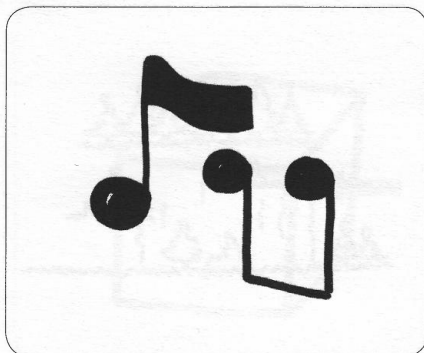

mote

note

onte

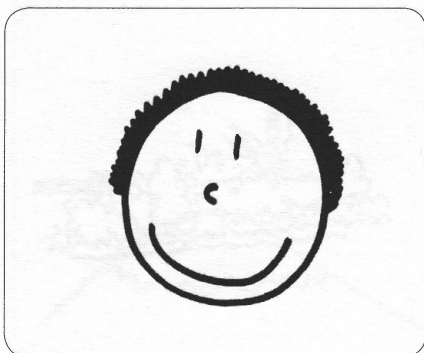

viso

fiso

vios

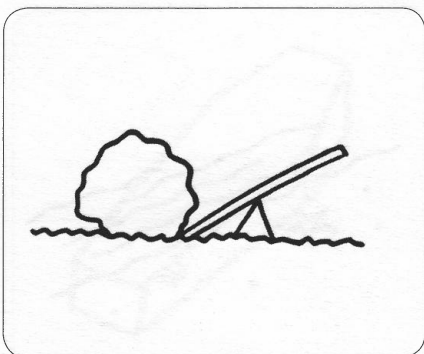

lefa

leva

lave

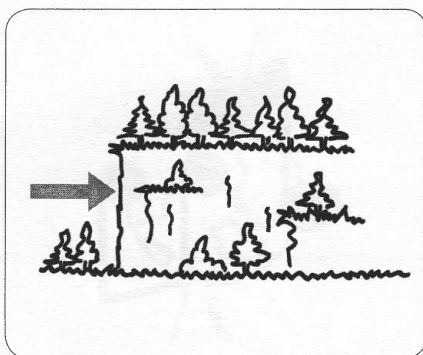

rube

rupa

rupe

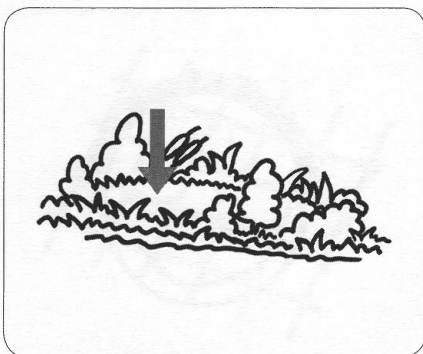

algo

lago

laco

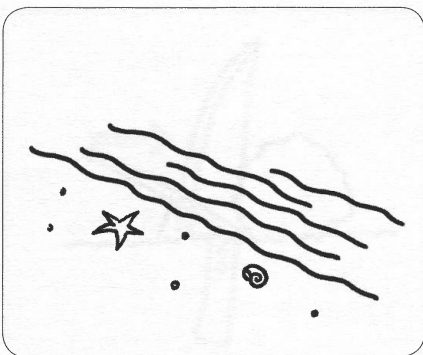

riva

rifa

irva

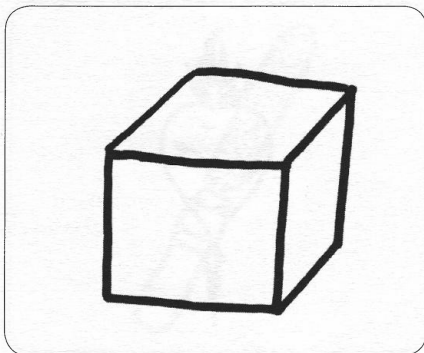

qubo	cubo	cudo
------	------	------

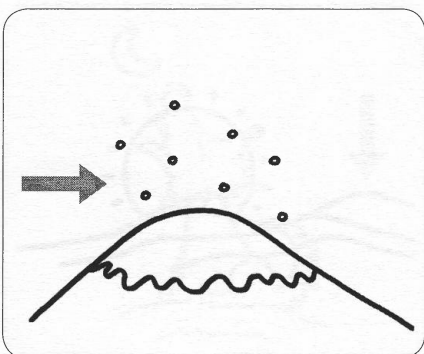

enve	nefe	neve
------	------	------

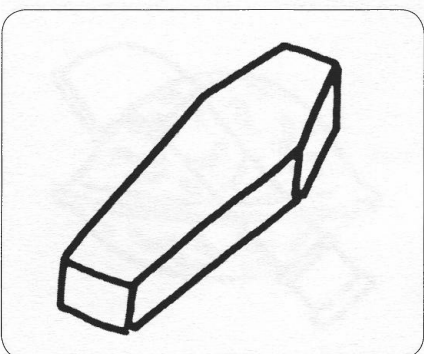

dara	bara	para
------	------	------



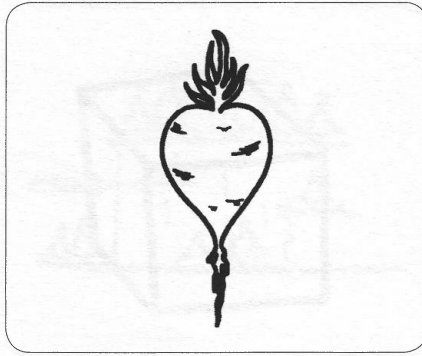

raqa

arpa

rapa

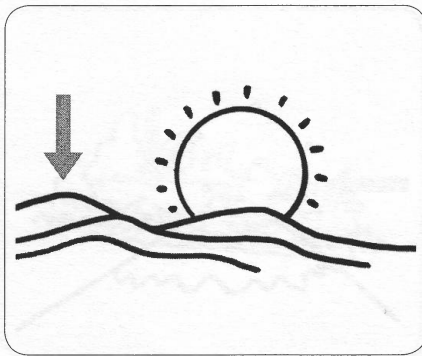

duna

buna

duma

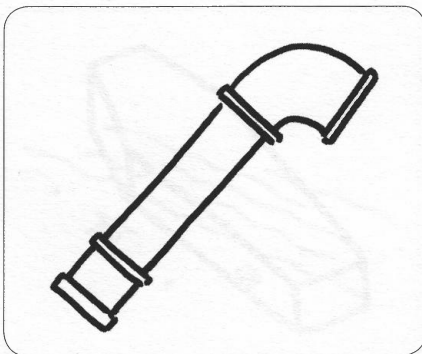

tubo

tupo

tudo

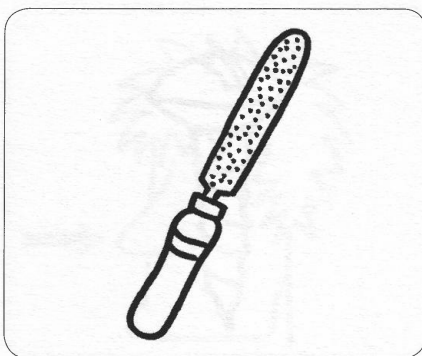

lina

lima

ilma



luqo

lubo

lupo

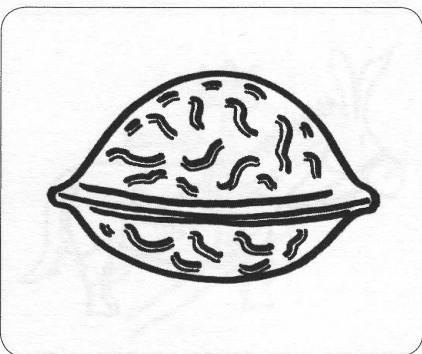

noce

once

noge

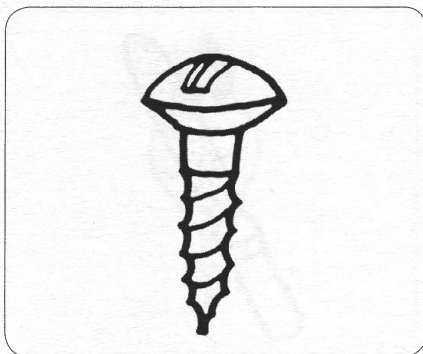

fite

vite

vide



ceco

geco

cego

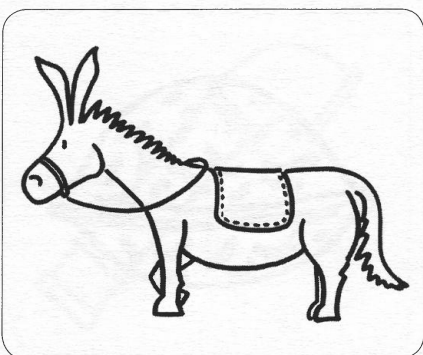

mulo

nulo

muol



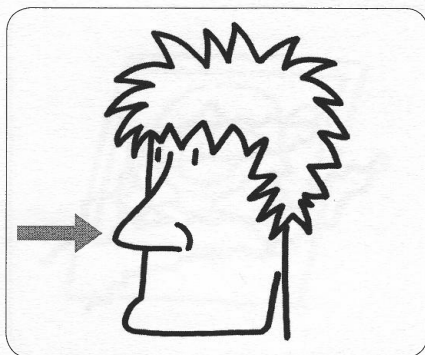

maso

naso

anso

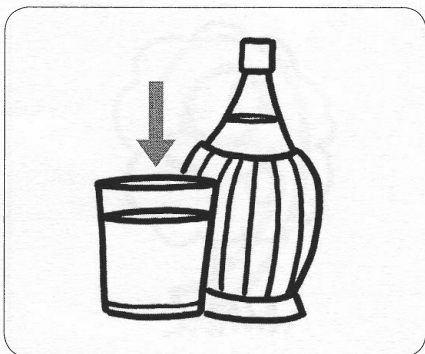

vion

fino

vino

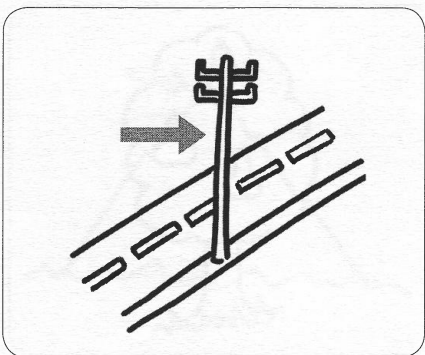

balo

palo

qalo

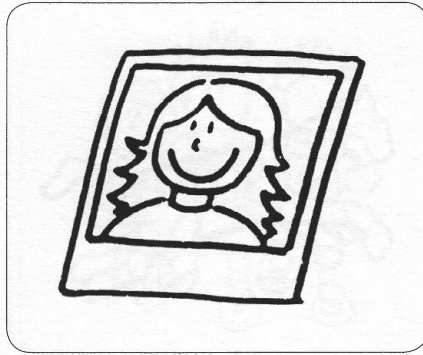

toto

foto

voto

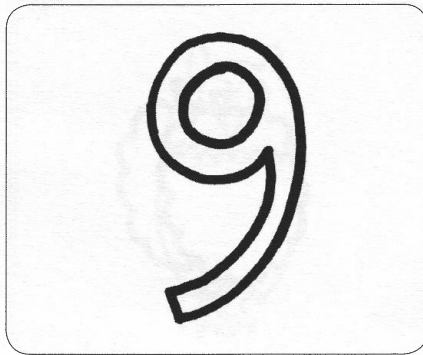

nove

nofe

onve

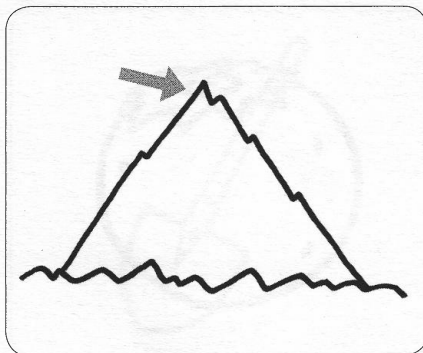

gima

cima

cina

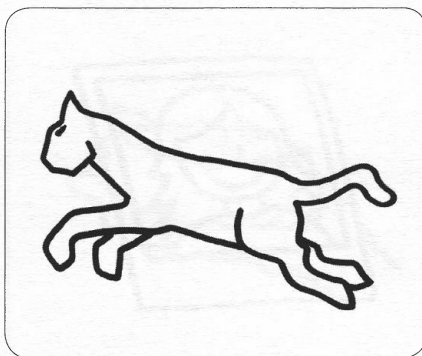

puna	quma	puma
------	------	------

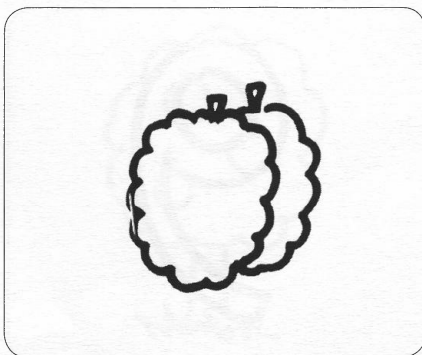

more	mroe	mope
------	------	------

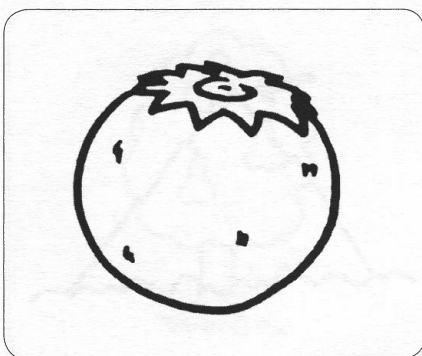

bomo	pomo	qomo
------	------	------



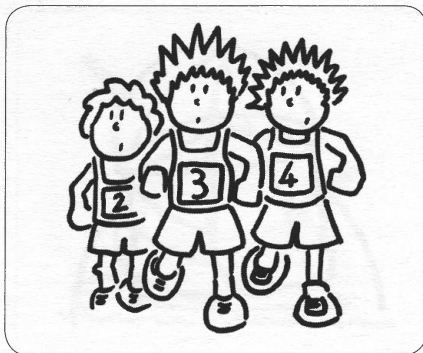

gara

cara

gere

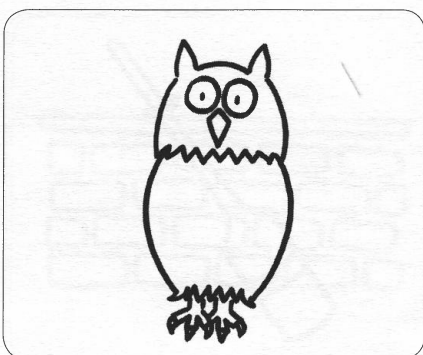

guvo

cufo

gufo

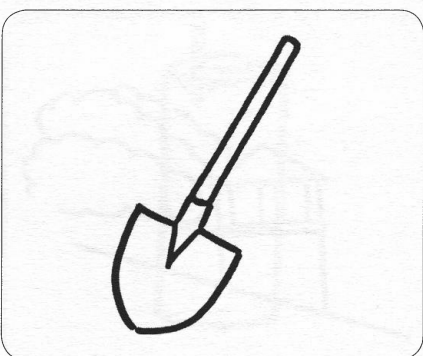

bala

pala

qala

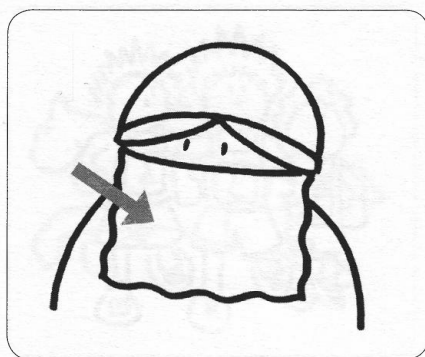

felo

velo

veol

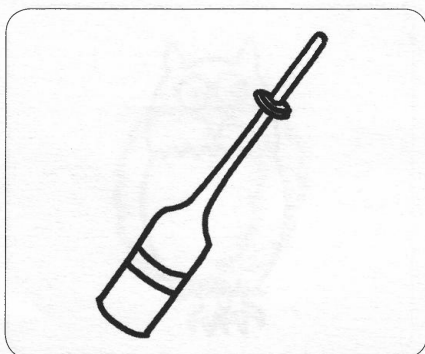

remo

ermo

reno

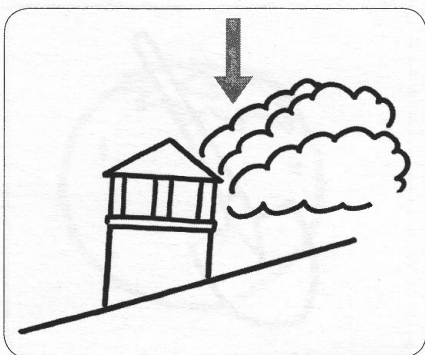

fumo

vumo

funo

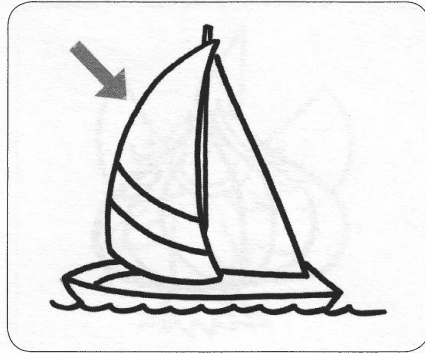

vale

fela

vela

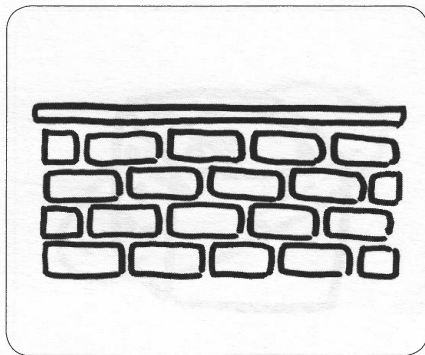

rumo

muro

nuro

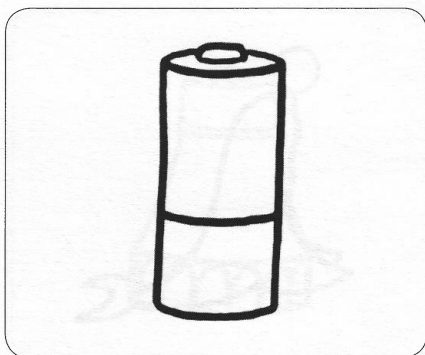

pila

qila

bila



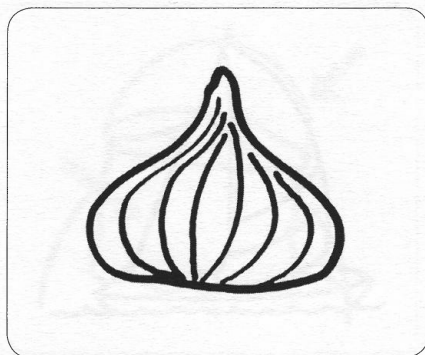

vico

fico

figo

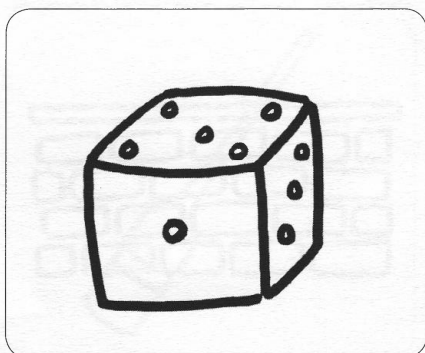

dado

babo

dato

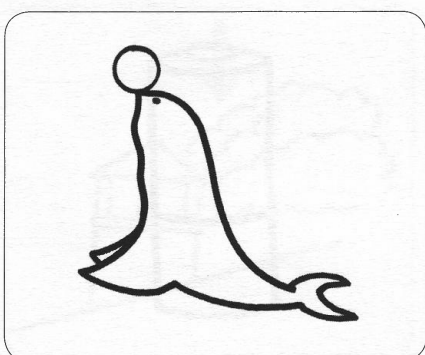

foga

voca

foca



vata

fata

fada

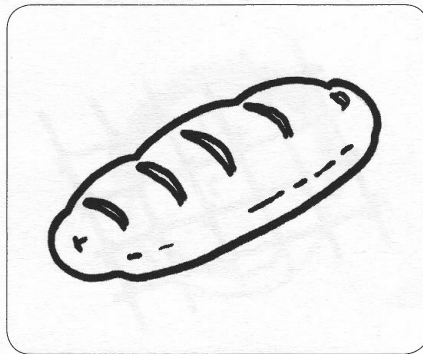

pane

bane

qane

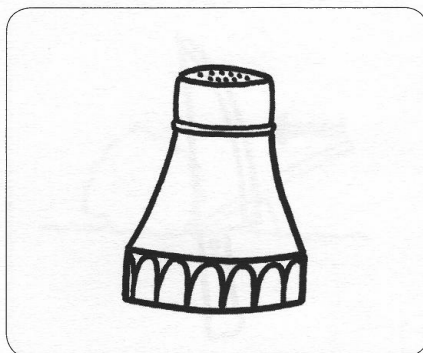

sela

zale

sale

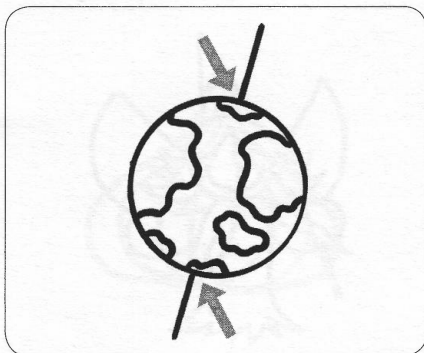

boli

poli

poil

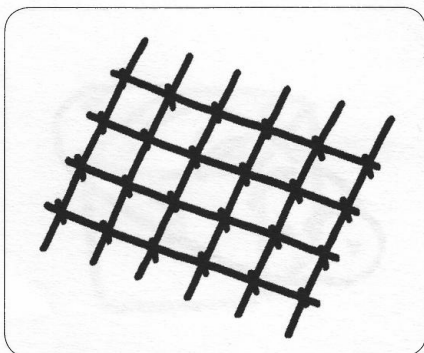

rede

rete

rate

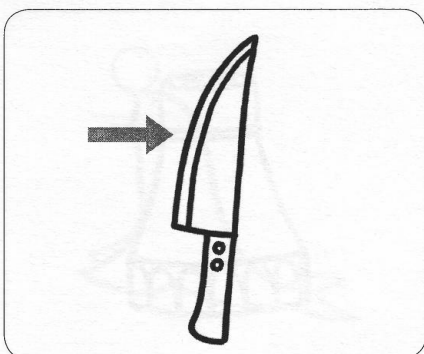

lama

lana

alma



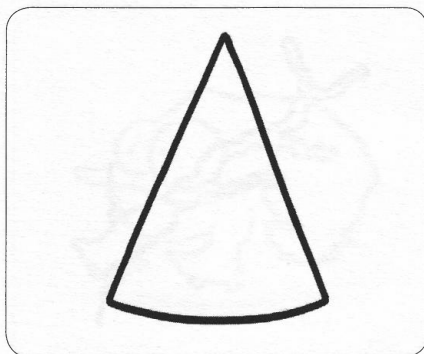

ocno

gono

cono

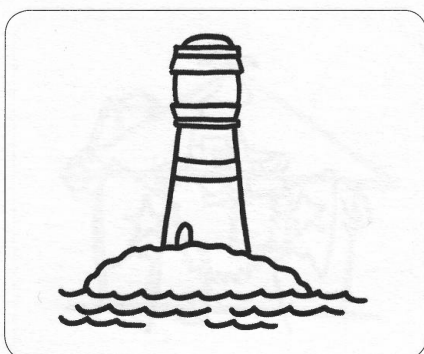

varo

faro

faor

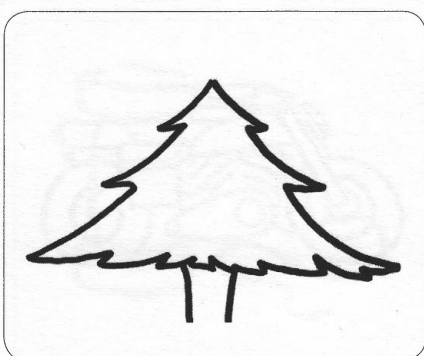

pino

bino

qino

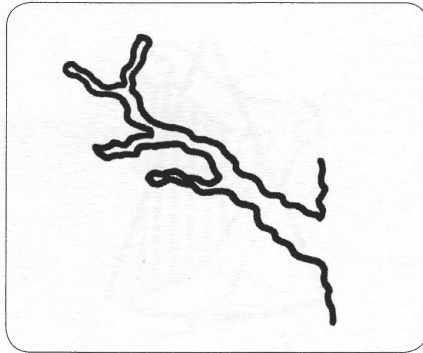

remo

ramo

raom



maoc

maco

mago

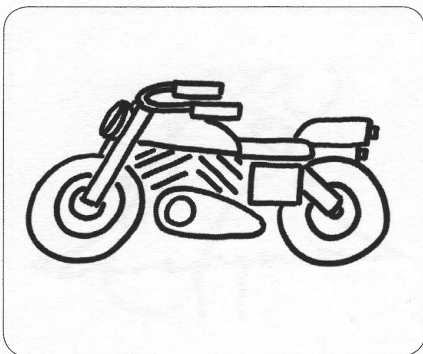

moto

noto

modo

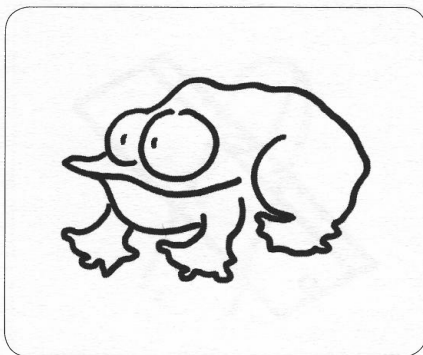

rama

rana

arna

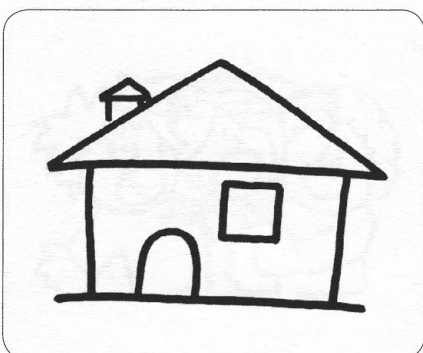

caza

casa

cesa

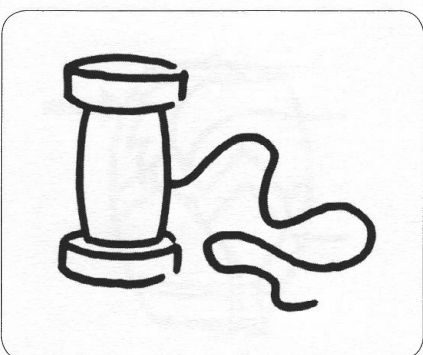

flio

fiol

filo



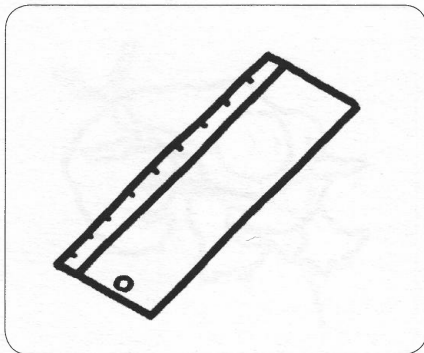

rica

irga

riga

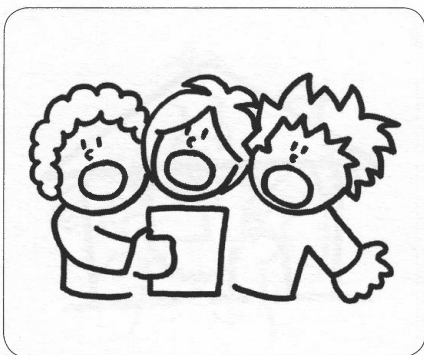

coro

goro

ocro

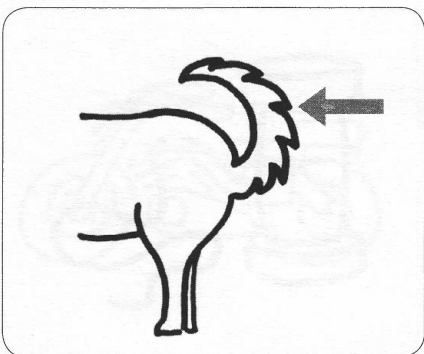

cota

goda

coda

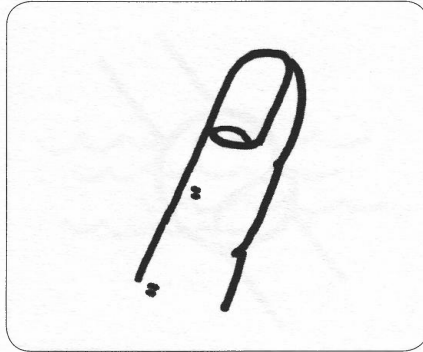

tido

dito

dido

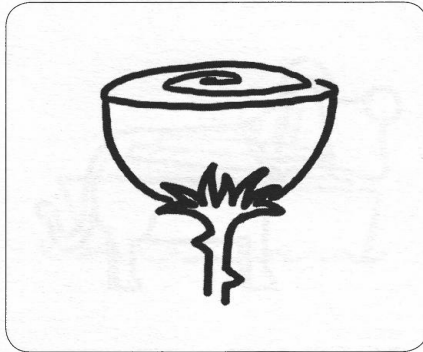

rosa

orsa

roza



vazo

faso

vaso

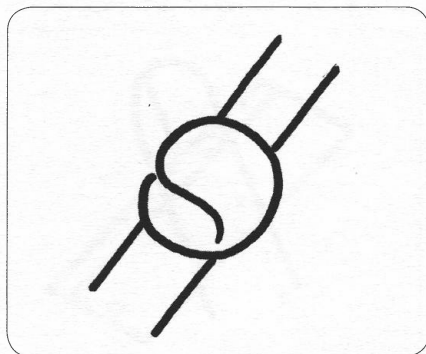

ondo

nobo

nodo

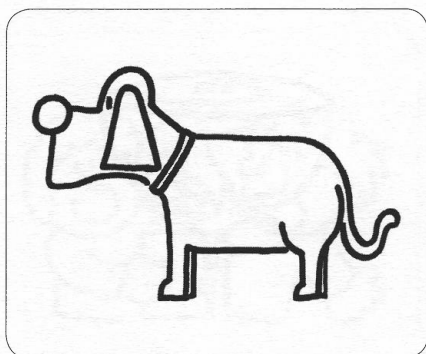

caen

cane

cena

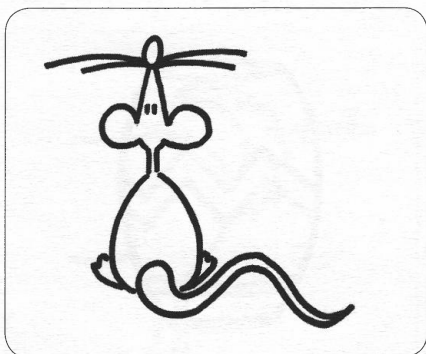

toqo

topo

otpo



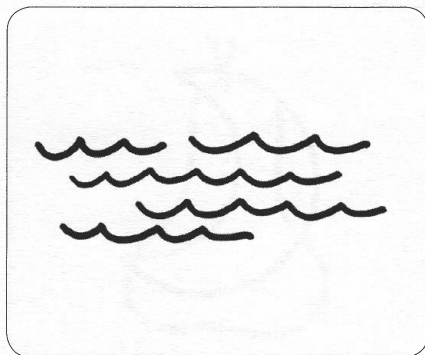

mare

mera

nare

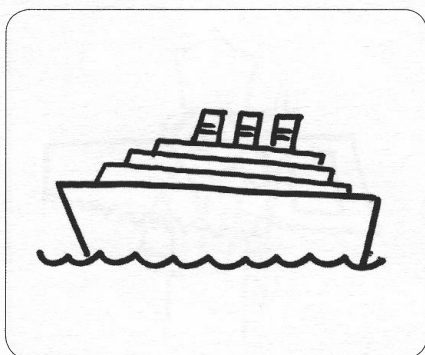

naev

nafe

nave

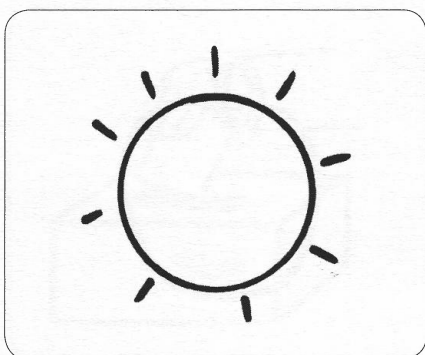

sale

sole

soel

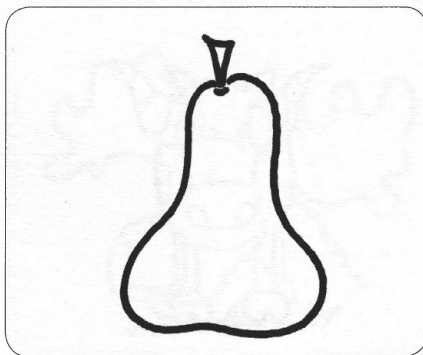

prea

pera

pela

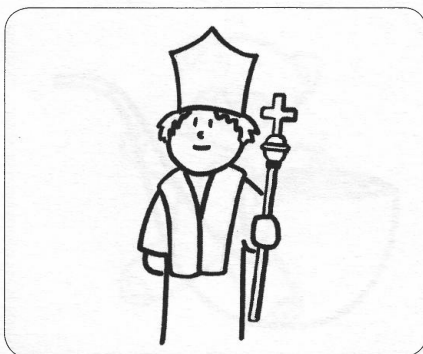

papa

qaqa

baba

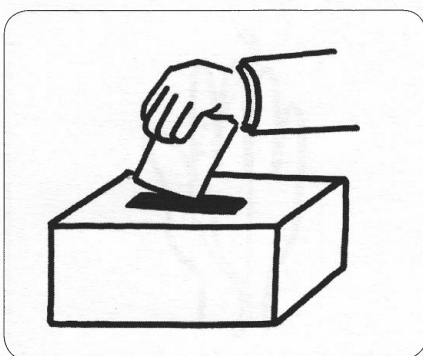

foto

voto

vodo

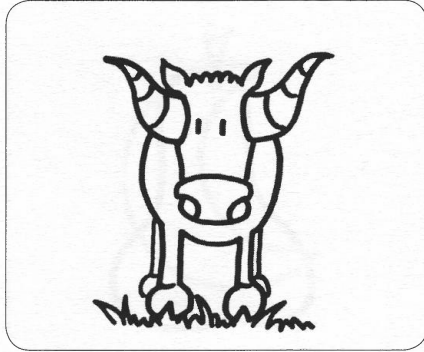

doro	tolo	toro
------	------	------

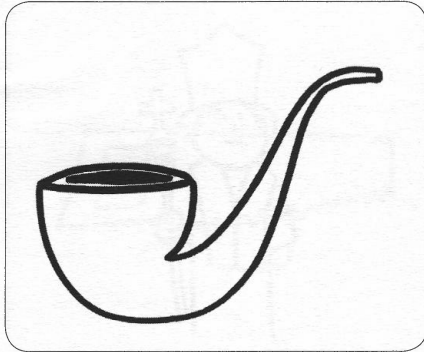

qiga	pipa	piba
------	------	------

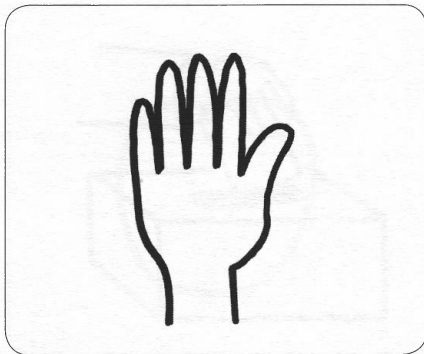

mano	maon	nano
------	------	------



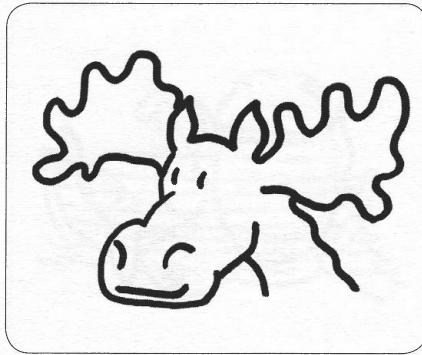

elca

alce

acle

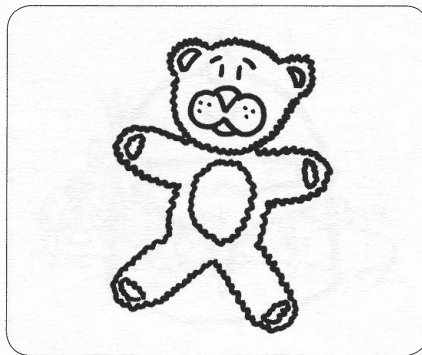

orso

orzo

osro

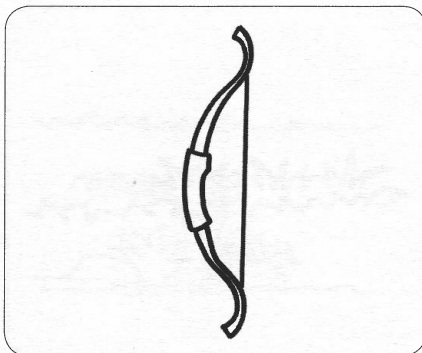

aroc

acro

arco

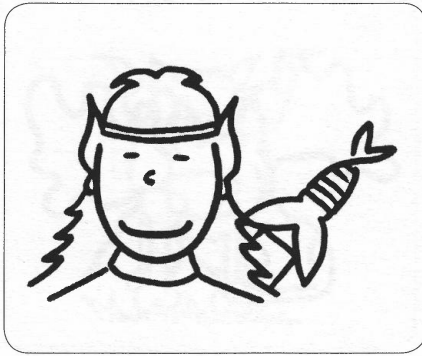

elfo	eflo	lefo
------	------	------

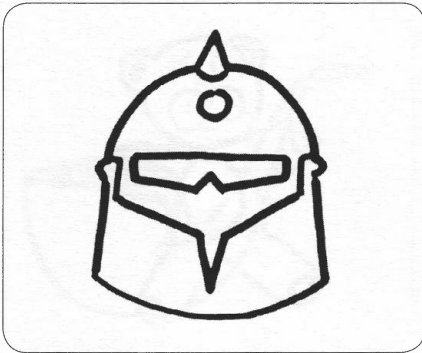

elmo	elom	lemo
------	------	------

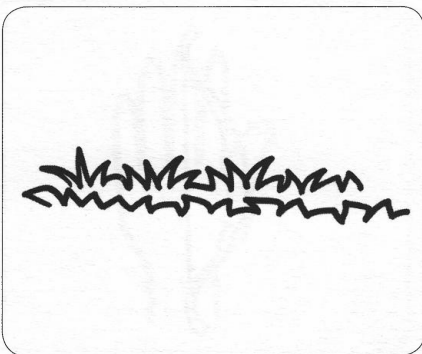

erab	ebra	erba
------	------	------

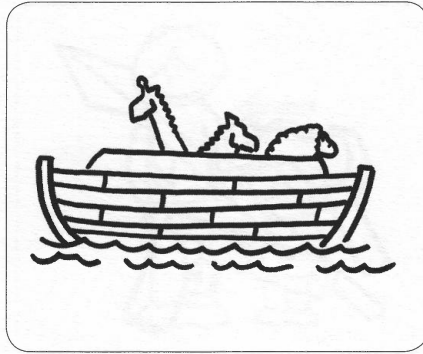

arac

acra

arca

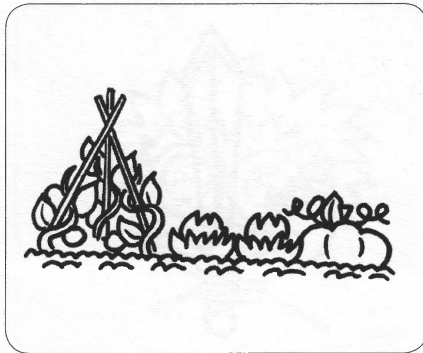

otro

orto

otor

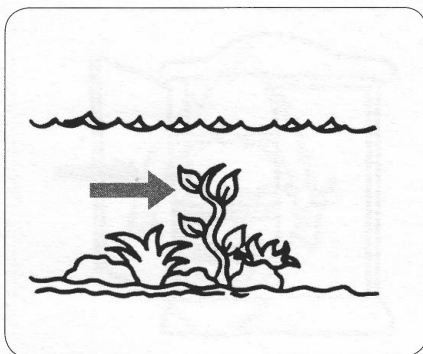

alga

agla

alag



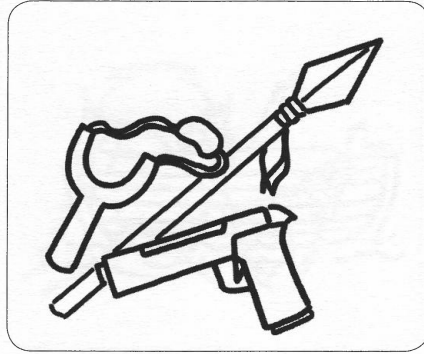

armi

rami

irma

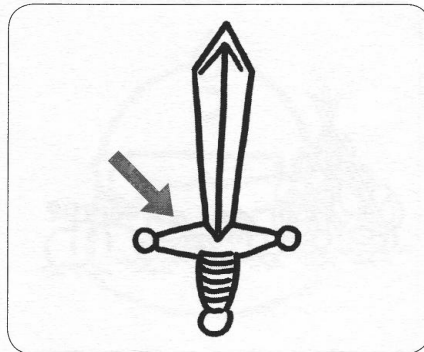

lesa

elsa

esla

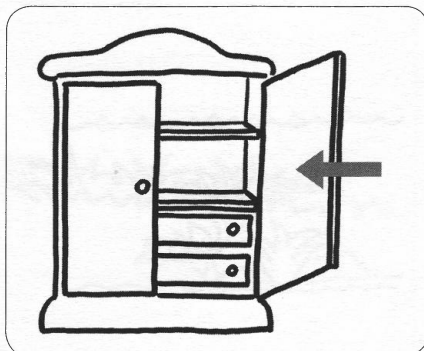

atna

nata

anta

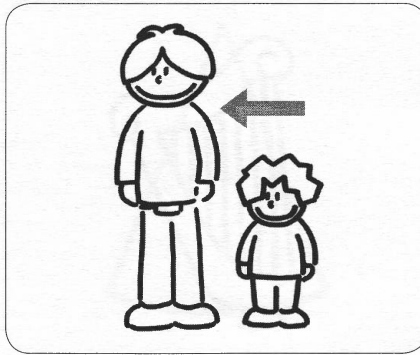

alto

atlo

alot

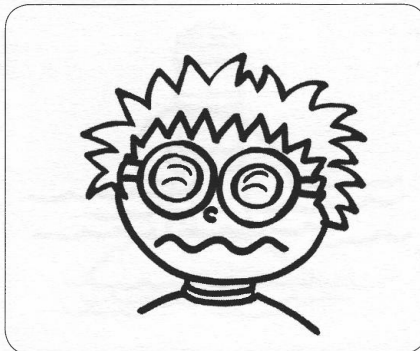

orob

ordo

orbo

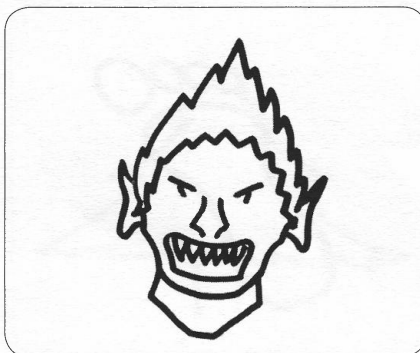

ocro

orco

oroc



apra

arpa

rapa

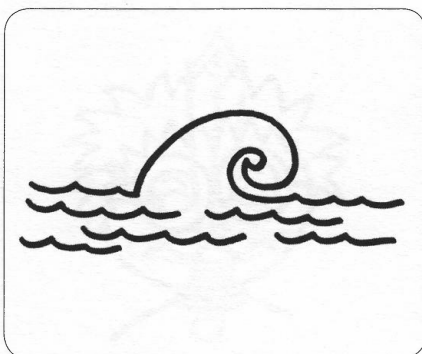

odna

noda

onda

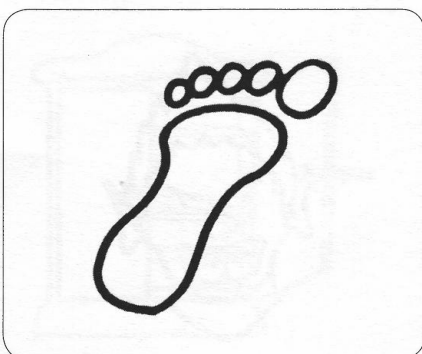

orma

mora

oram



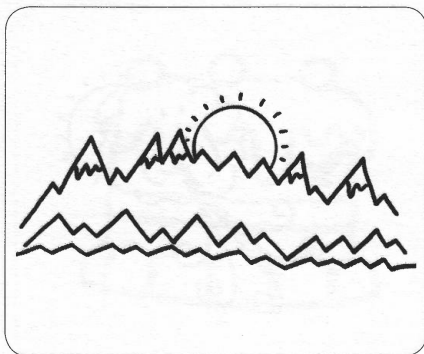

alip

alpi

apli

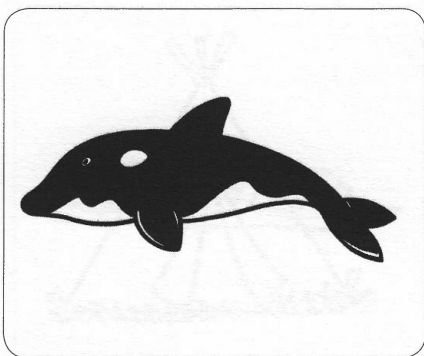

orca

oarc

arco

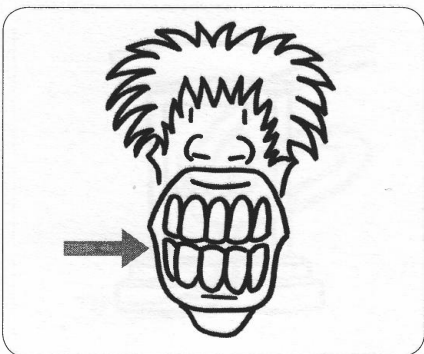

denti

detni

tenti

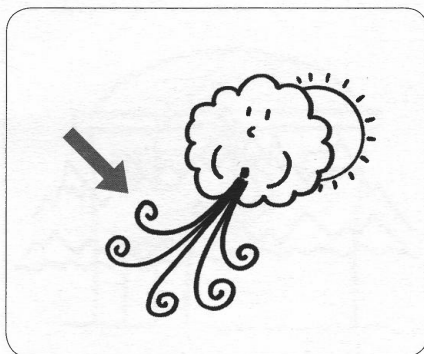

veton

vento

fento

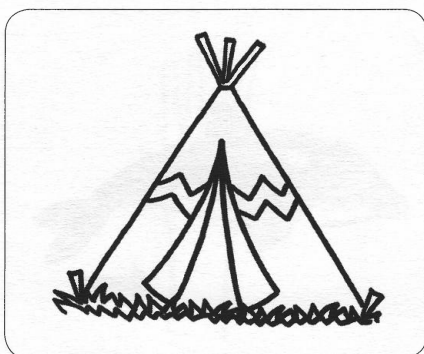

tedna

tenda

tenta

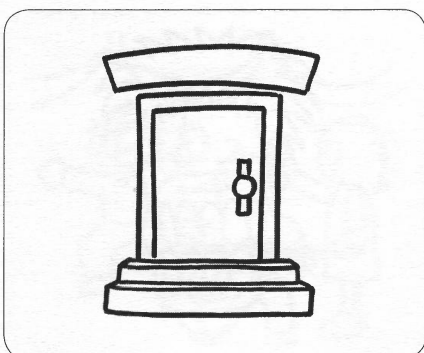

polta

potra

porta

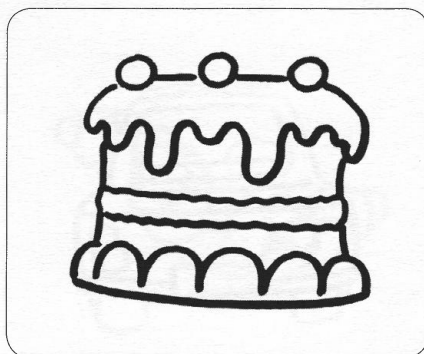

tolta

torta

trota

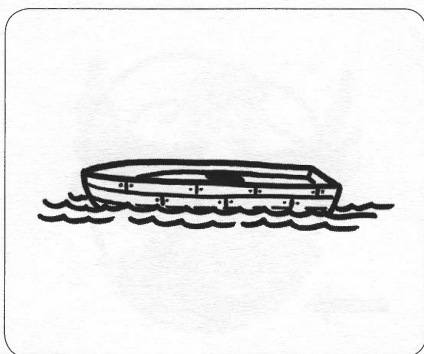

barca

braca

barac

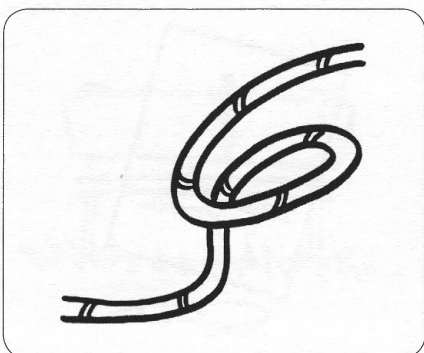

corta

corda

codra



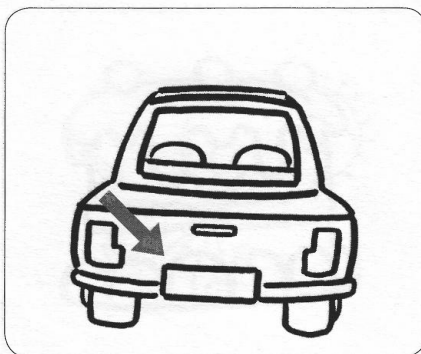

tarca	traga	targa
-------	-------	-------

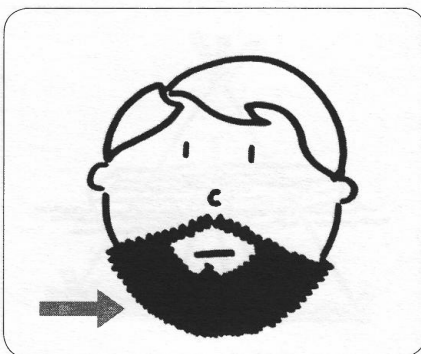

barba	barpa	bamba
-------	-------	-------

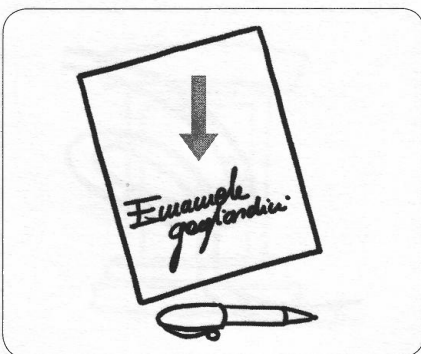

firna	frima	firma
-------	-------	-------

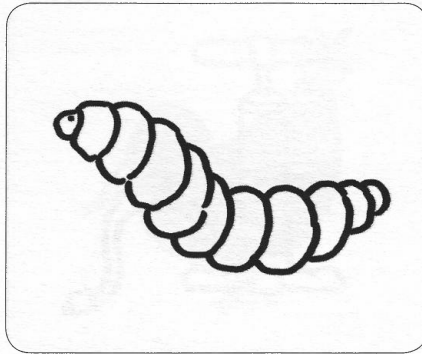

verme

ferme

vreme

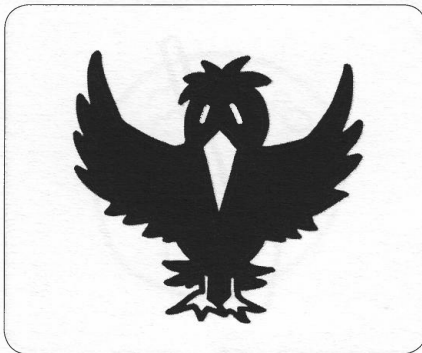

crovo

corfo

corvo

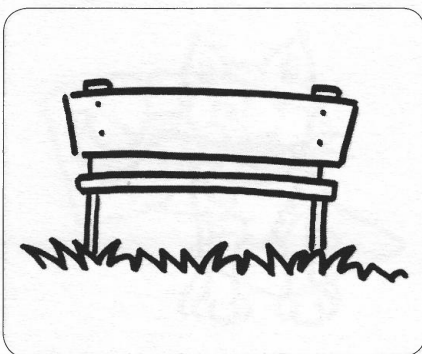

pacna

panca

banca

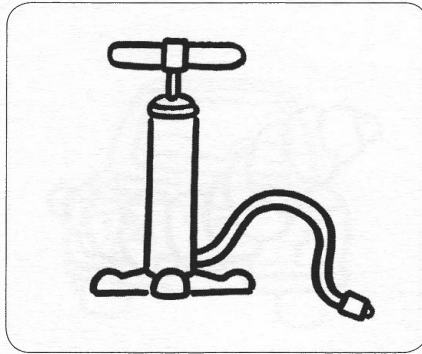

pompa

ponpa

popma

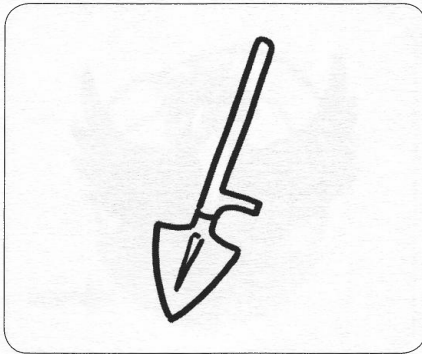

fagna

fanga

vanga

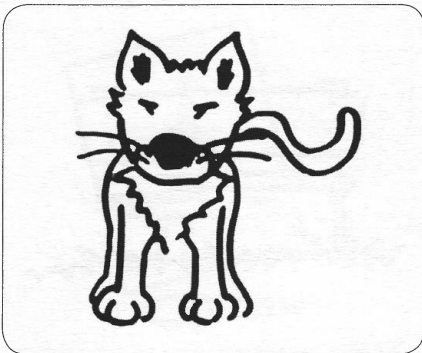

lince

linge

ilnce



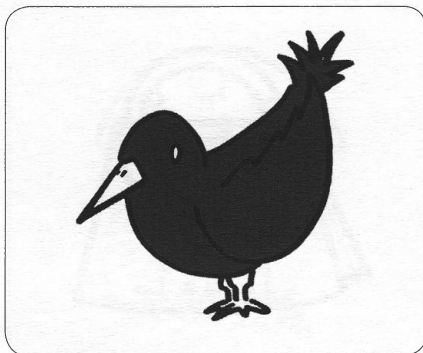

melor

merlo

mrelo

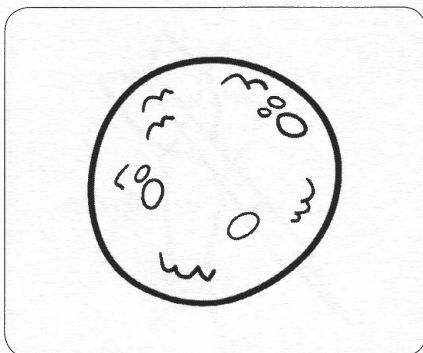

maret

matre

martre

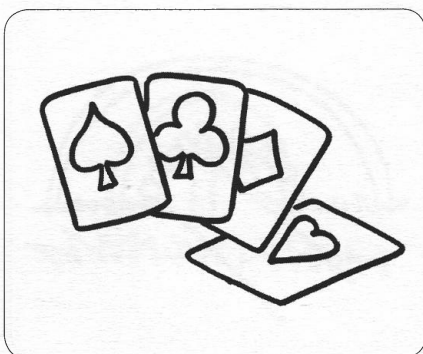

certa

carte

crate

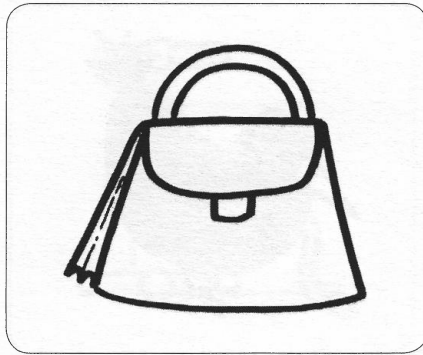

borsa

dorsa

boras

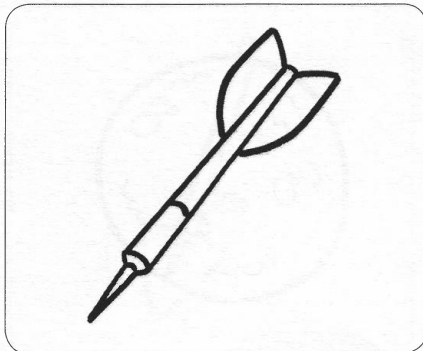

pardo

dardo

barbo

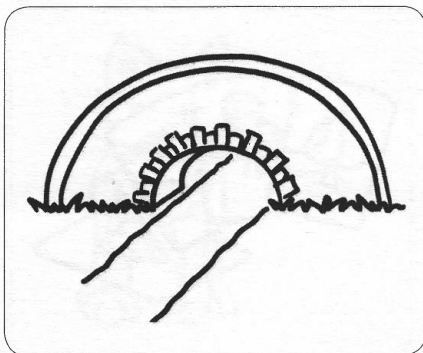

potne

ponet

ponte



vungo

fungo

funco

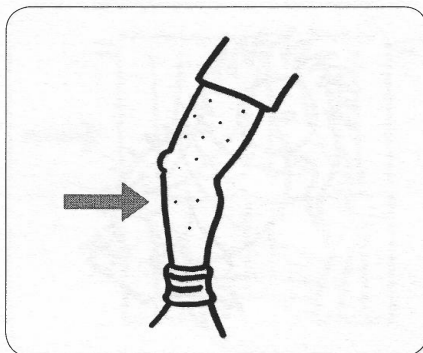

gamba

ganba

gamda

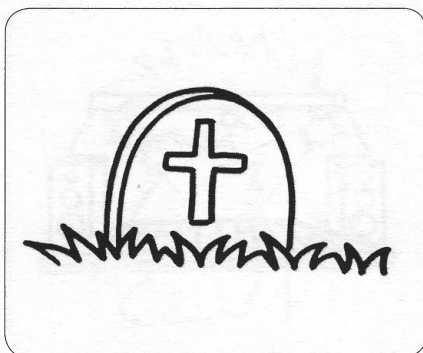

tonba

tomba

tobma



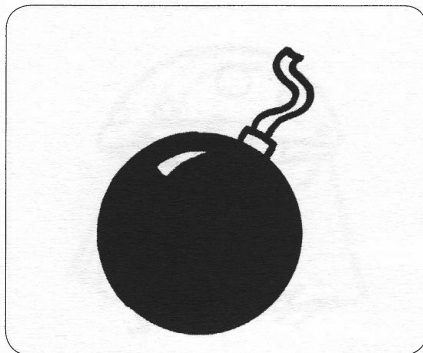

bonba

domda

bomba

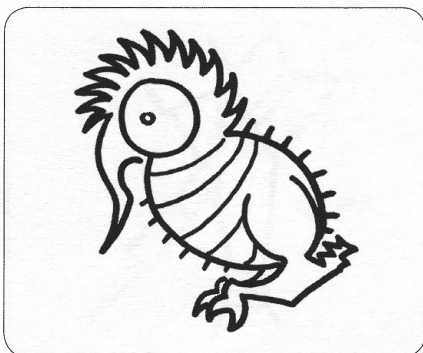

pulce

punce

pulge

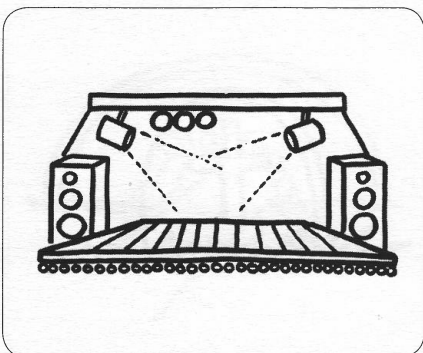

placo

panco

palco

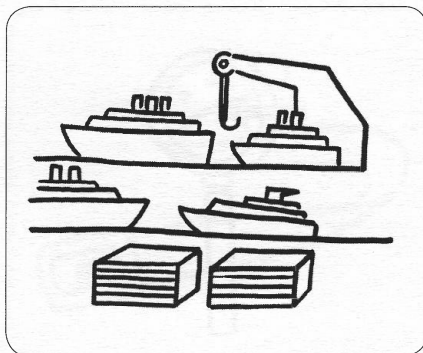

proto

porto

potro

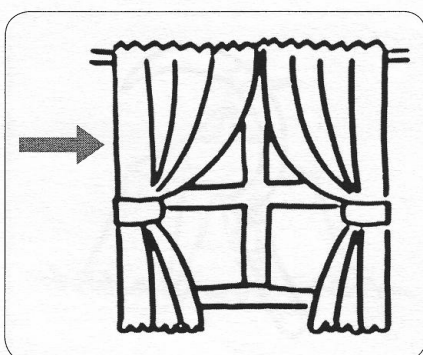

tnede

tente

tende

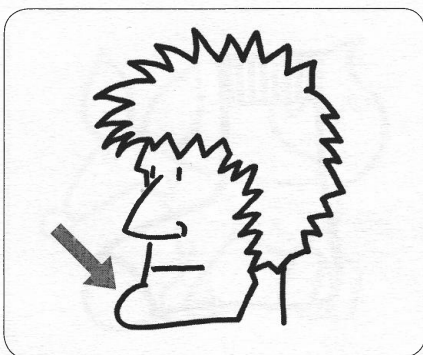

mento

manto

nento

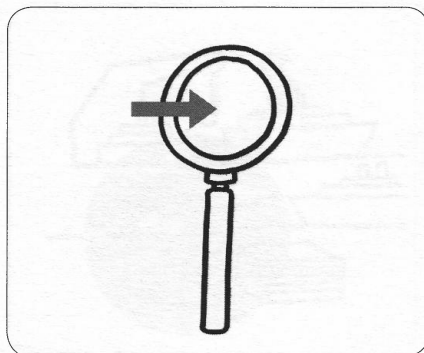

lende	letne	lente
-------	-------	-------

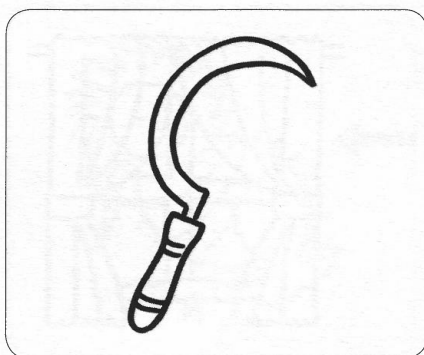

falge	falce	fance
-------	-------	-------

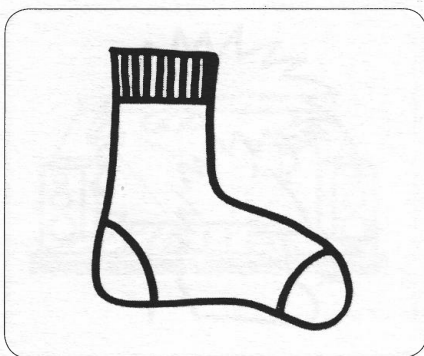

calza	calsa	cazla
-------	-------	-------



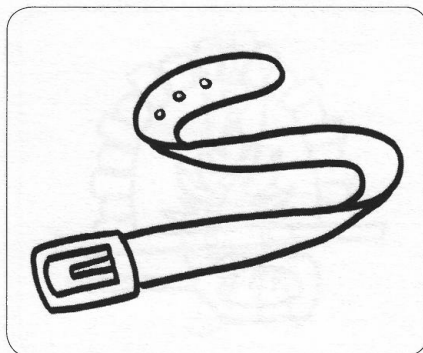

cinda

ginta

cinta

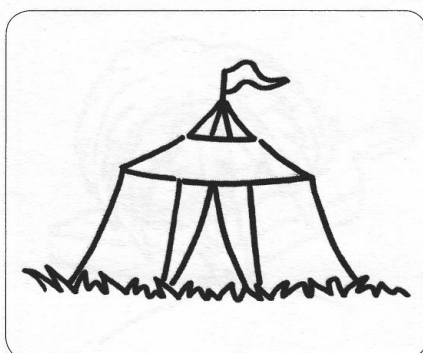

cirgo

circo

cicro

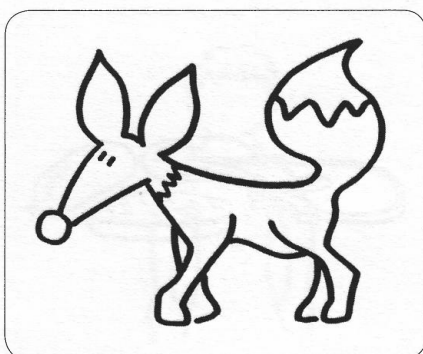

vlope

vompe

volpe

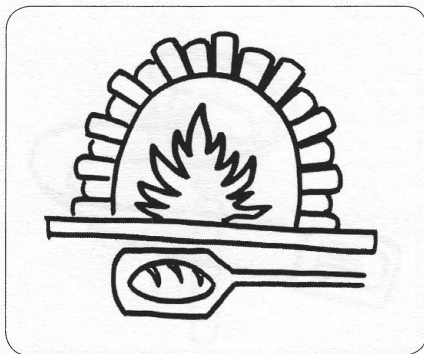

forno

vorno

fonno

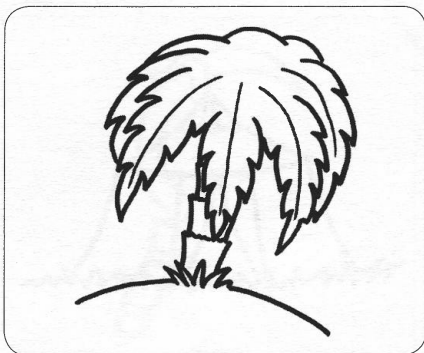

pamal

plama

palma

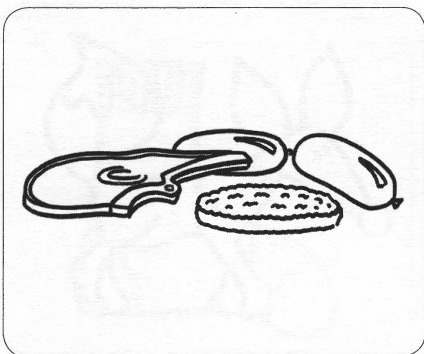

crane

carne

canre

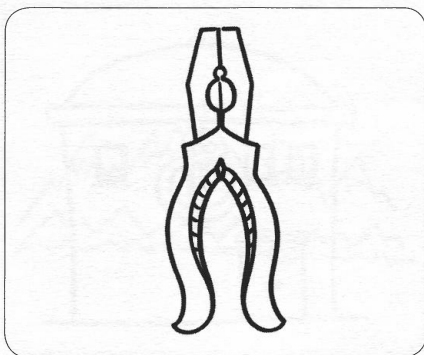

pinsa

binza

pinza

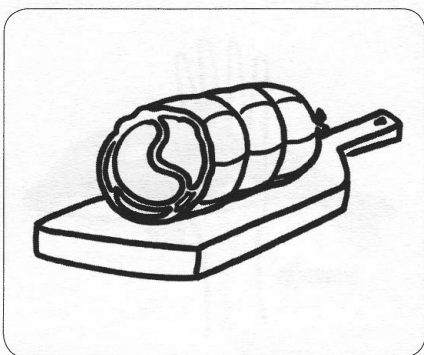

lozna

lonza

lonsa

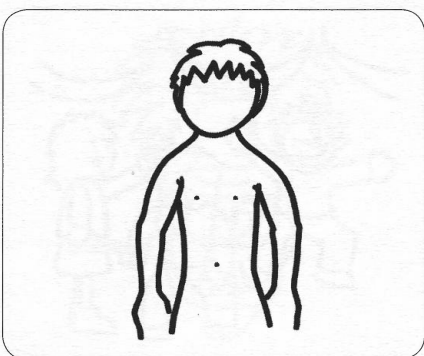

corbo

copro

corpo