

patsore

psatore

pastore



postino

pottino

spostino



coslaro

scuolaro

scolaro

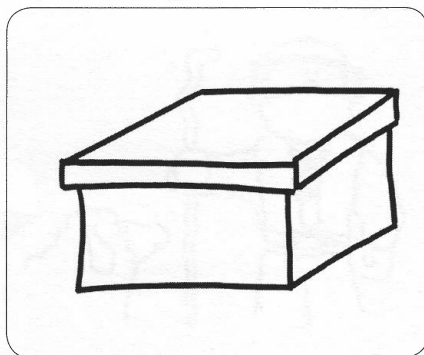

scatola

catola

castola

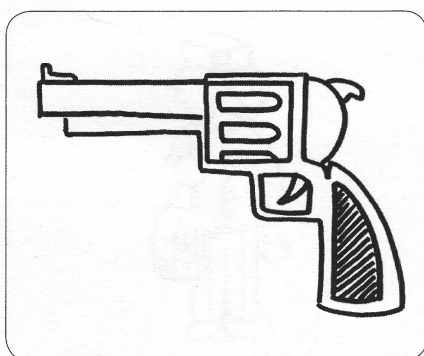

pitsola

pistola

spitola

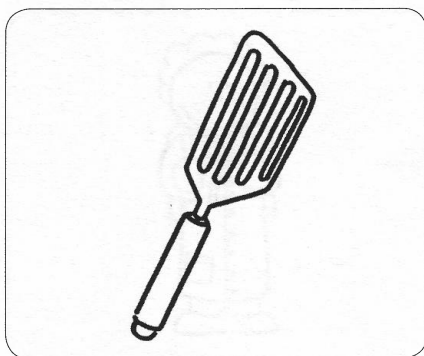

pastola

spatola

patsola

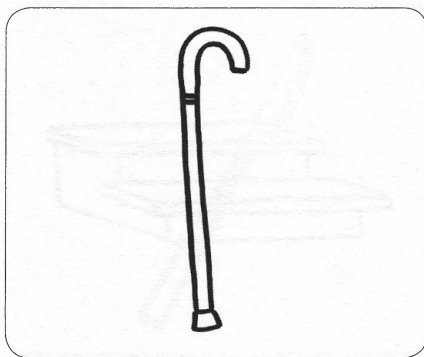

pastone

sbattono

bastone

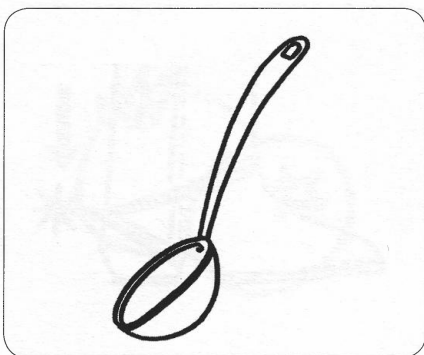

mesotlo

mestolo

metsolo



stivali

sitvali

stivlali



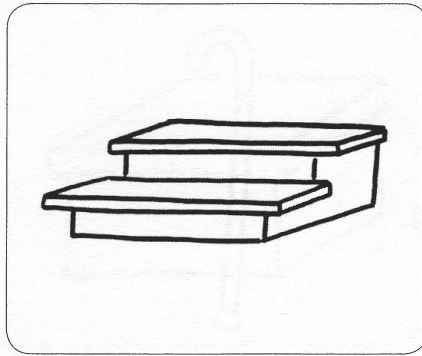

caslino

scalino

sclaloni

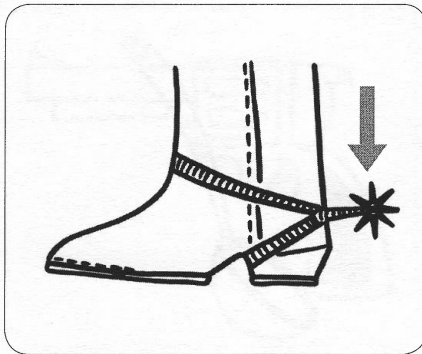

seprone

spernone

sperone

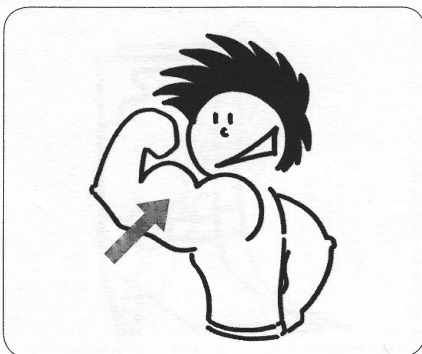

mucsoli

muscoli

musocoli



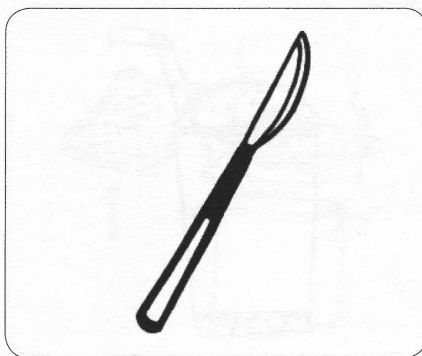

bitsuri

bistrui

bisturi

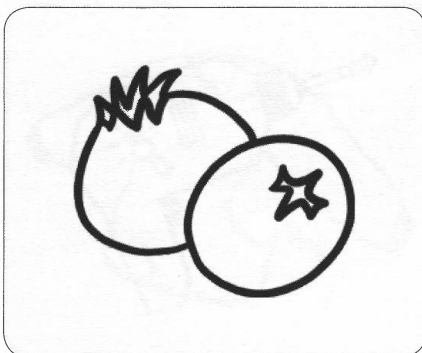

nespole

nesploe

nepsole

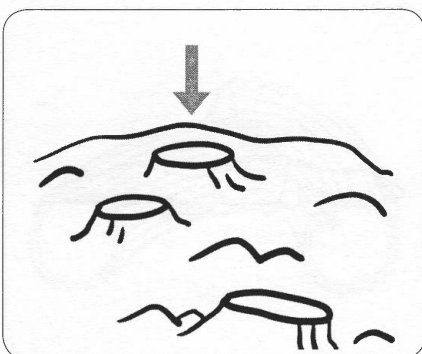

cartere

cratere

caratere

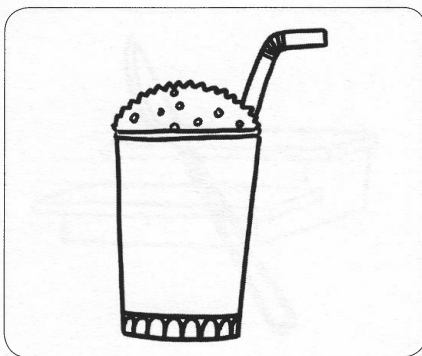

granita	garnati	gnarita
---------	---------	---------

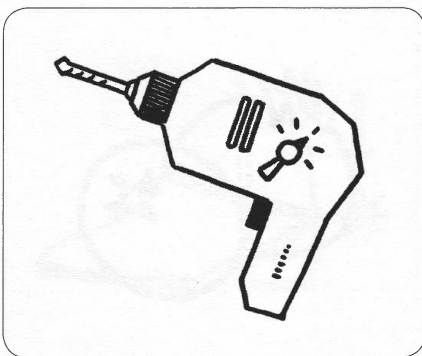

trapano	tarpano	taprano
---------	---------	---------

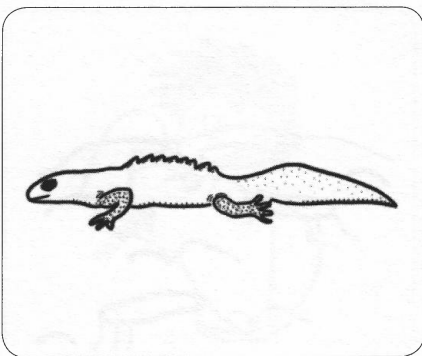

titrone	tirtone	tritone
---------	---------	---------

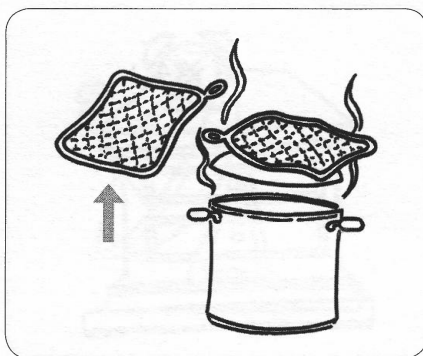

preisna

persina

presina

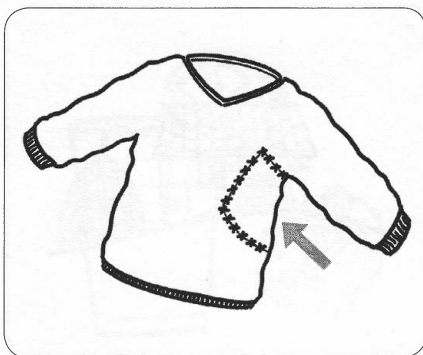

ciucitura

cucitura

cuicitura

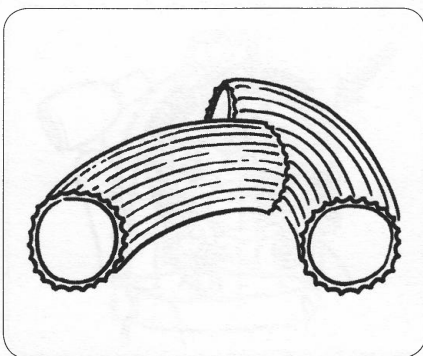

rigatoni

irgatoni

ricatoni



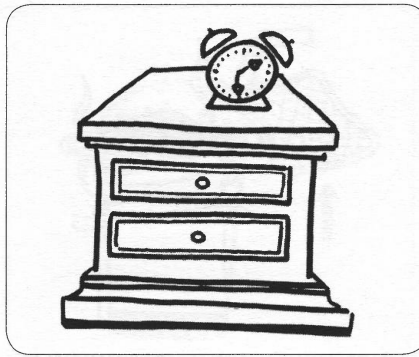

comodino

codomino

comidono

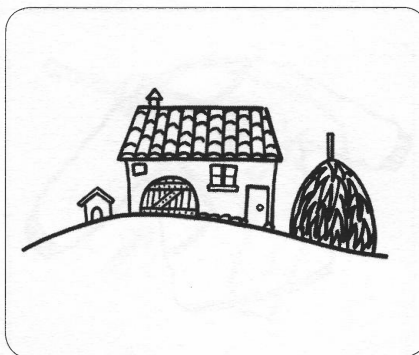

casolare

carosale

casloare

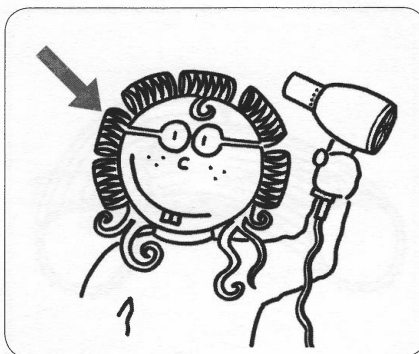

bicodini

dibogini

bigodini

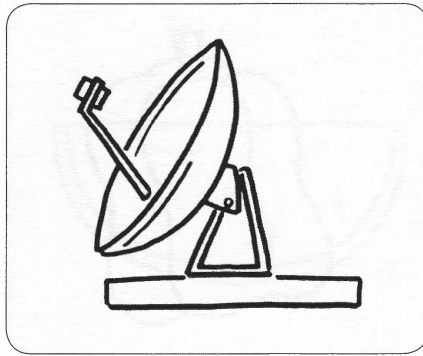

paraobla

barapola

parabola

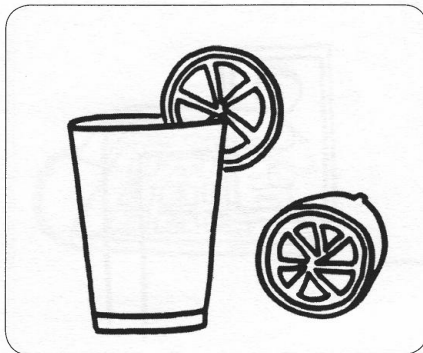

linomata

limonata

limnonata

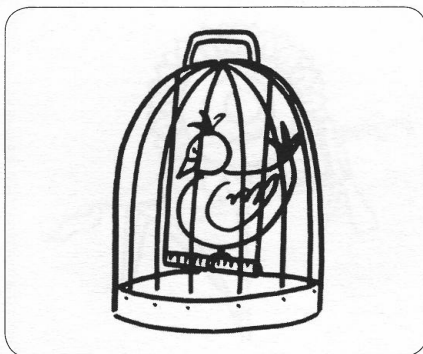

caranino

canairno

canarino

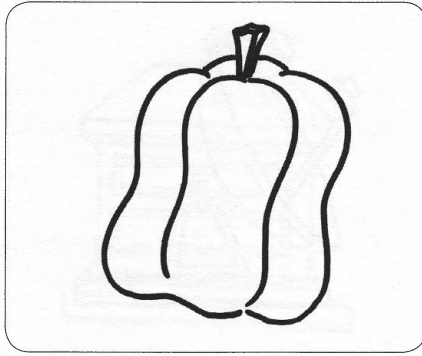

peperone

perepone

preperone

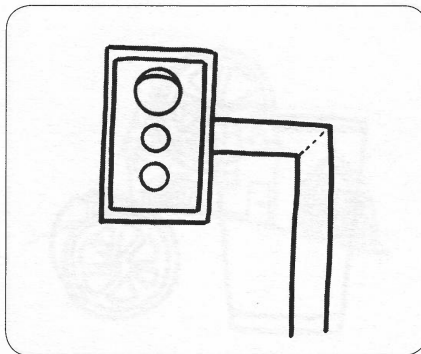

semafero

semaforo

smeaforo

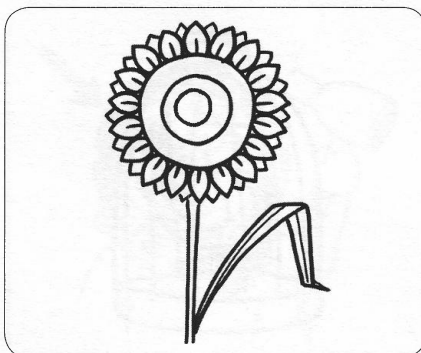

girasole

gisarole

giraslole



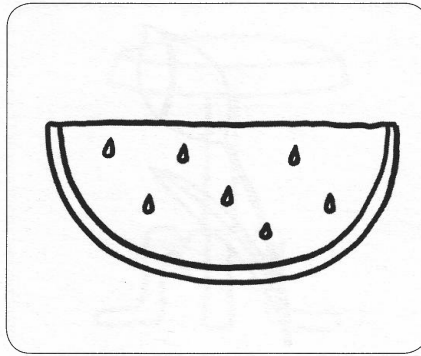

cogomero

cocomero

cocomreo

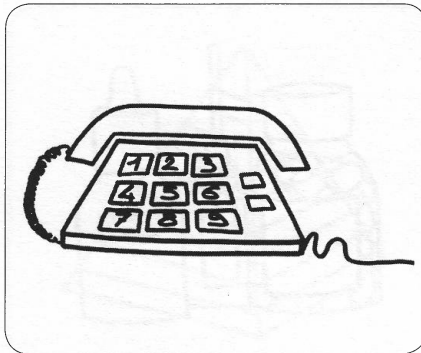

telefono

tefelono

telefnono

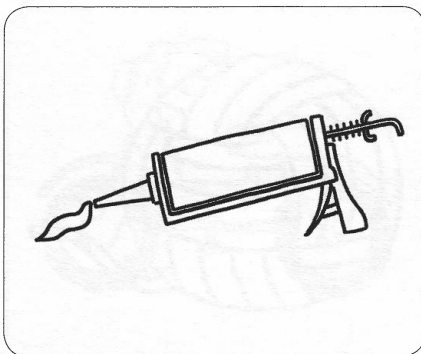

sillicone

silcione

silicone



militare

mitilare

militrare

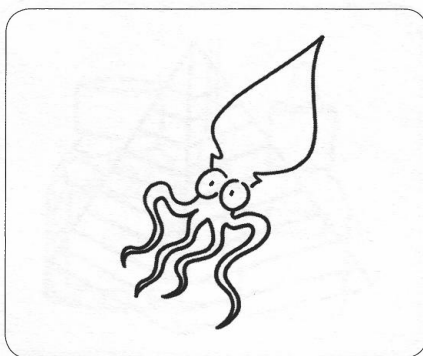

calmararo

calamaro

camalaro

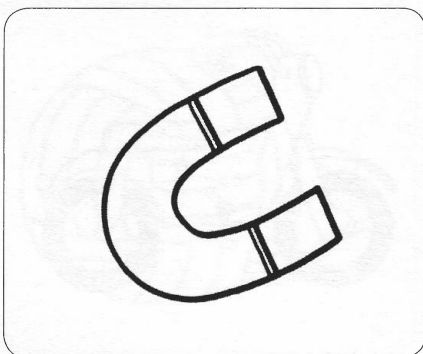

camalita

calamtita

calamita

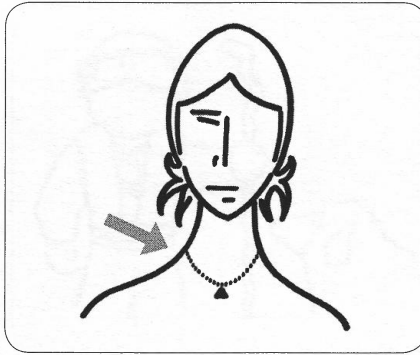

canetina

catnenina

catenina

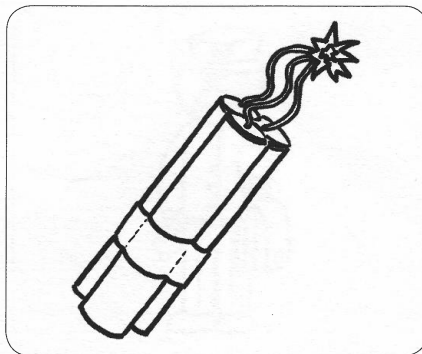

binamite

dinamite

dinaimte