

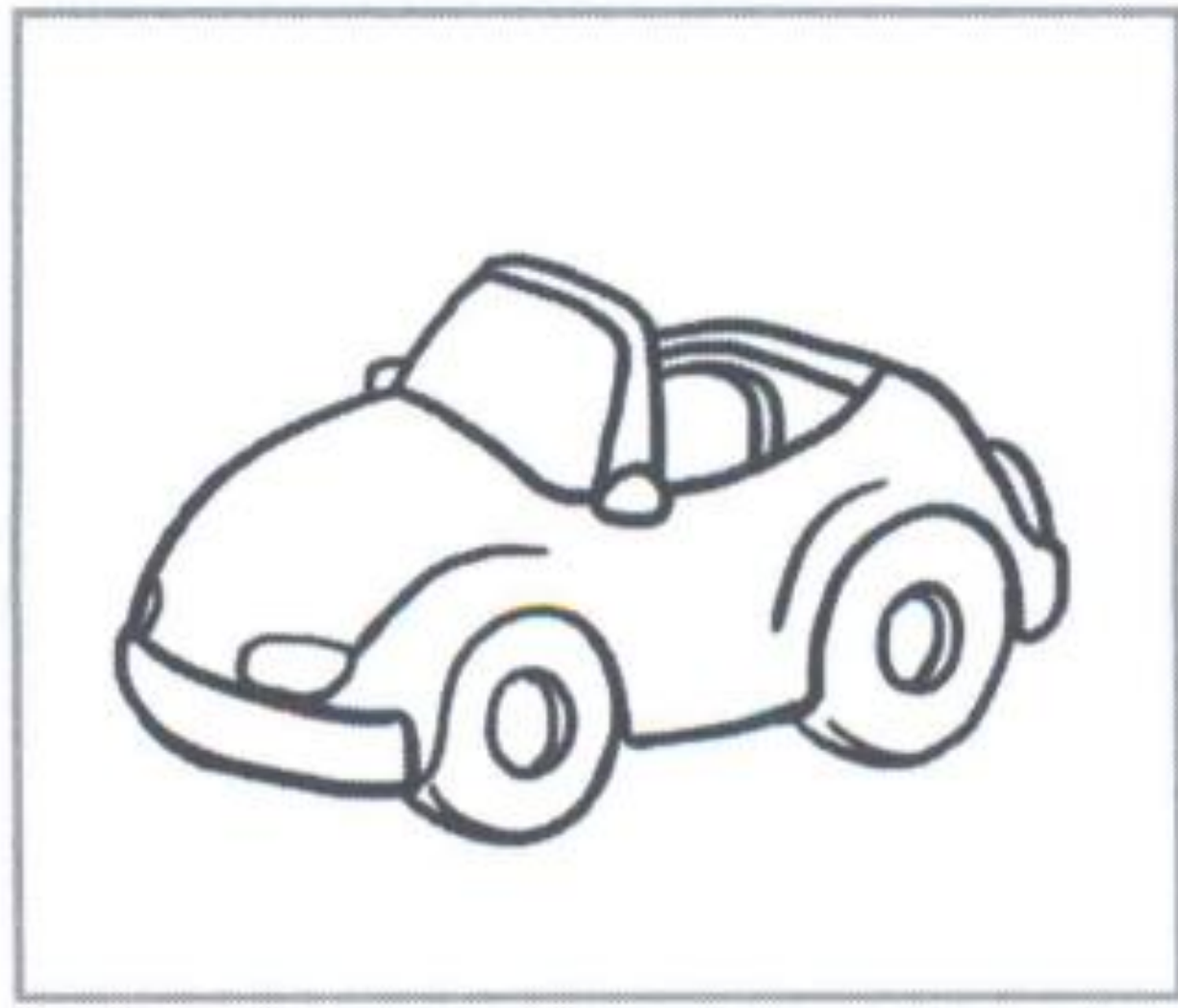

# LE FRASI



OSSERVA, LEGGI E RIPASSA L'ARTICOLO DETERMINATIVO GIUSTO



L'

AUTO

LA

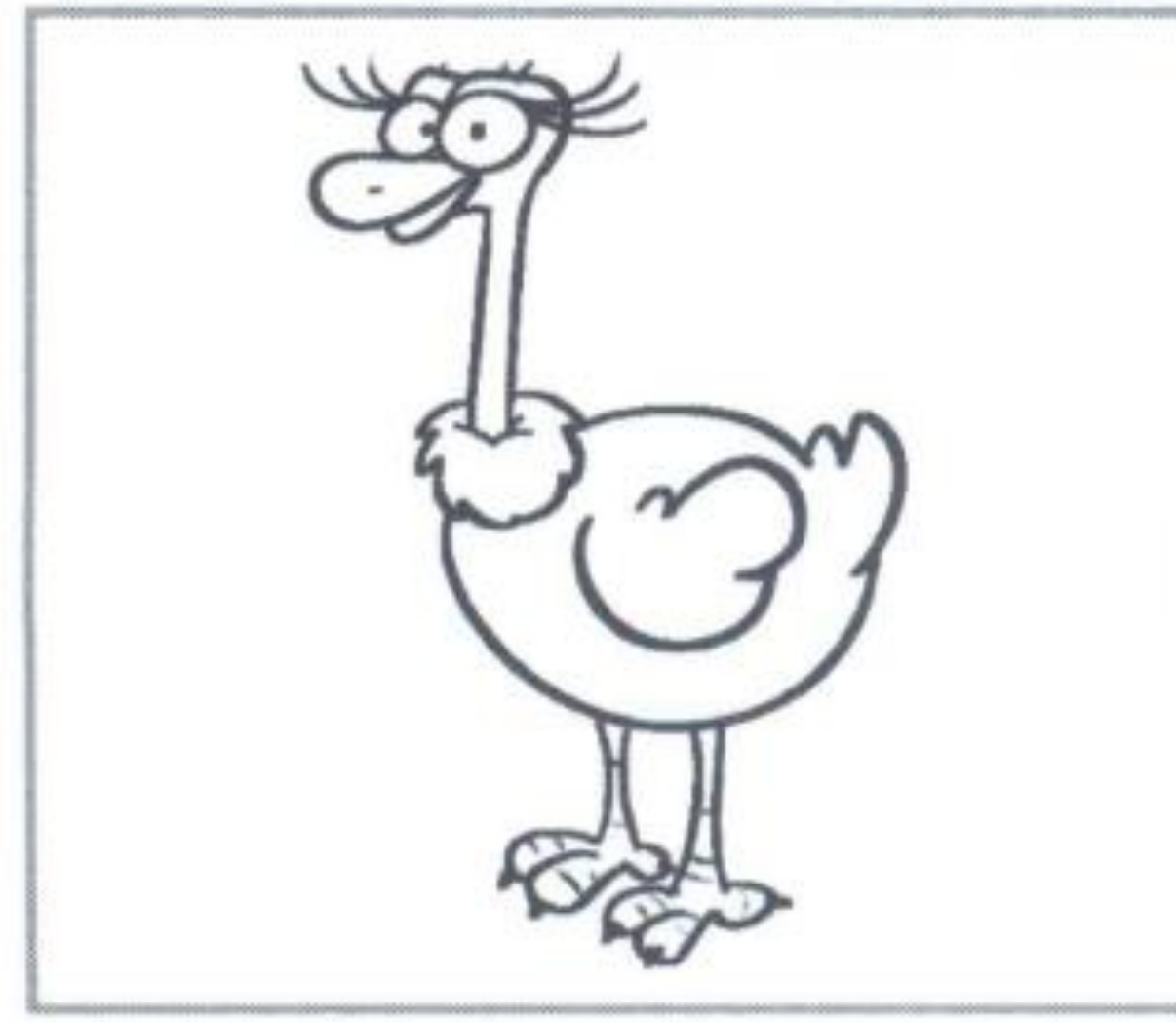

LO

STRUZZO

IL



LA

RUSPA

IL

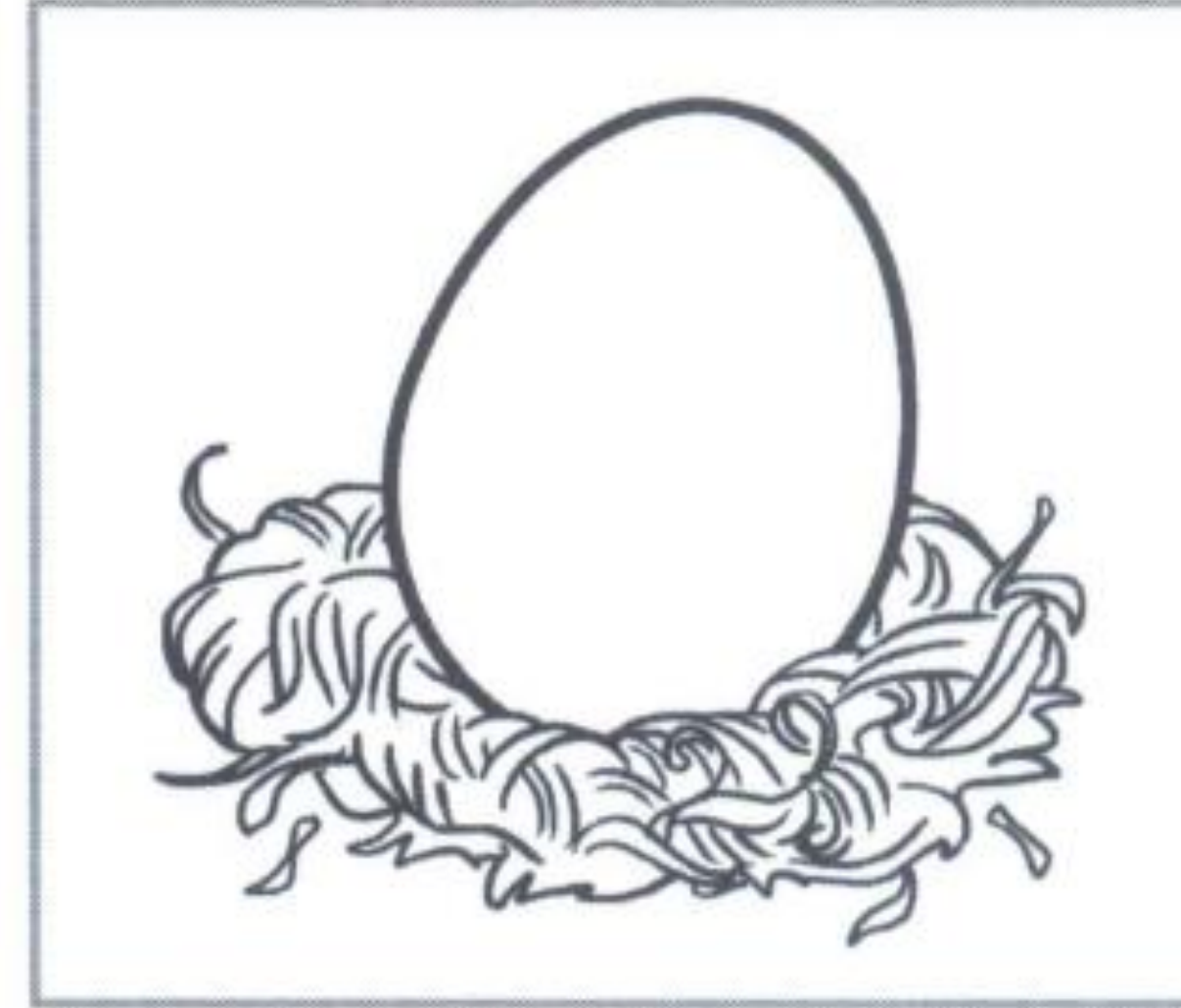

L'

UOVO

LO

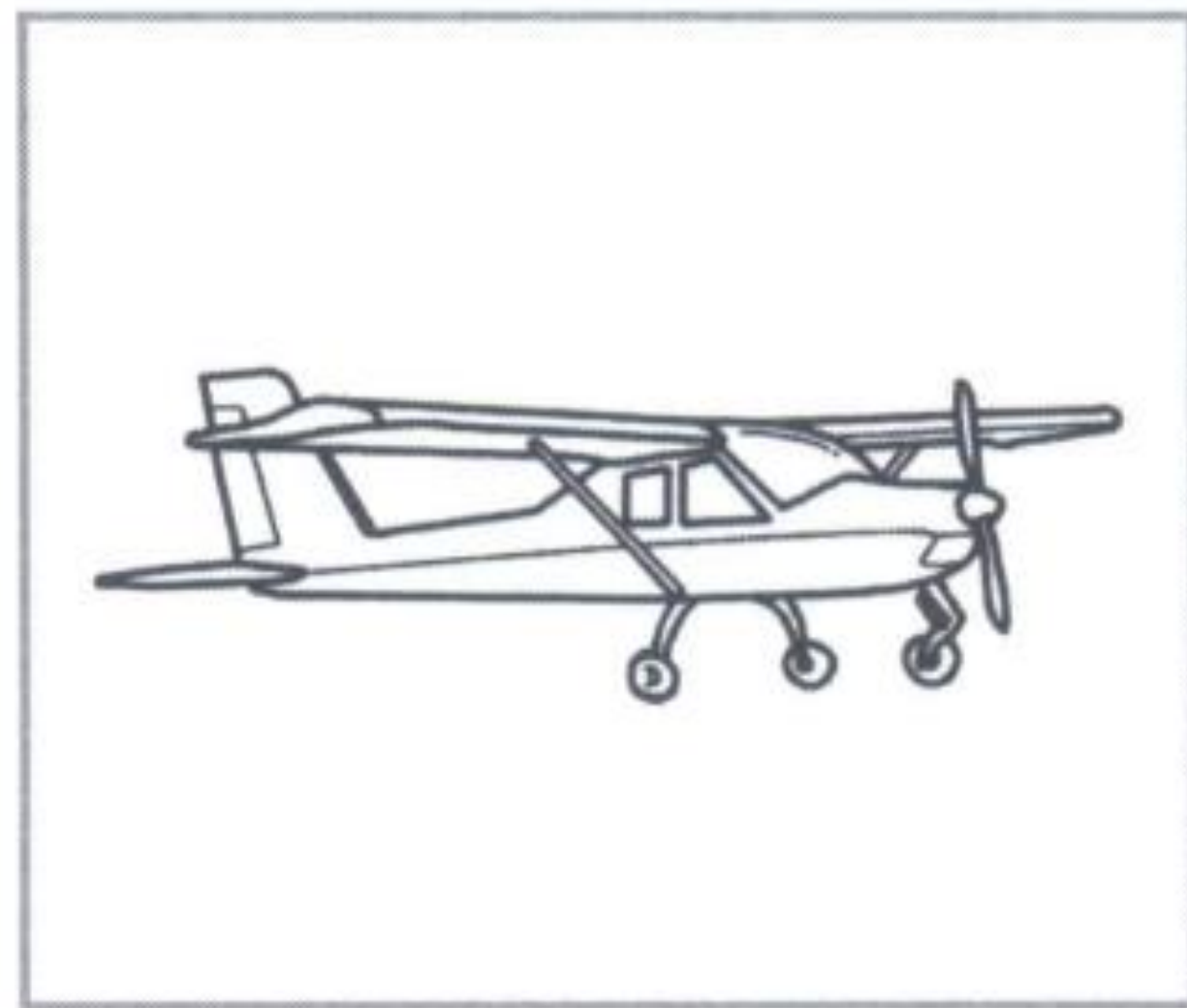

LO

AEREO

L'



L'

SCIVOLO

LO



L'

NUVOLA

LA

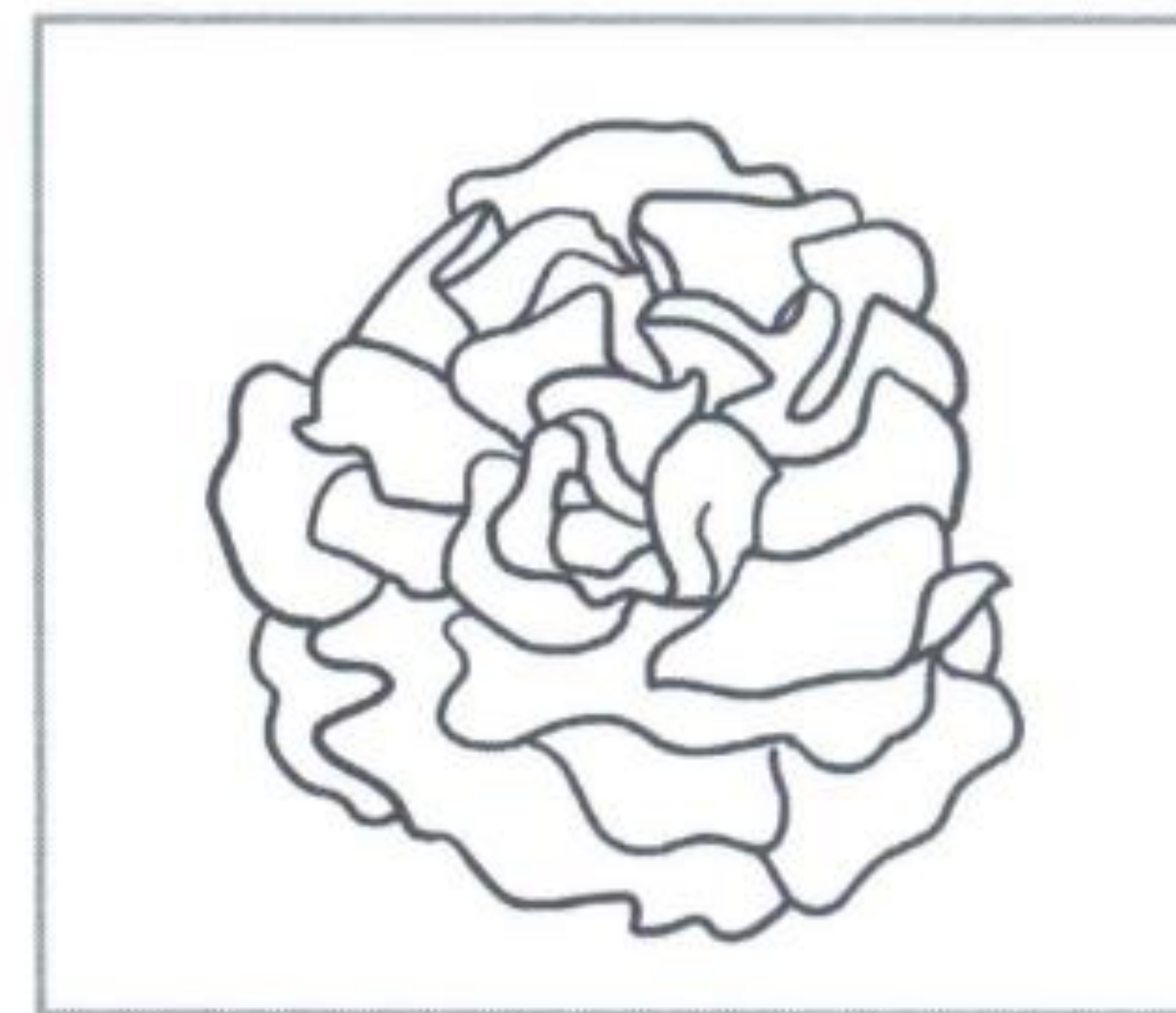

L'

INSALATA

LA

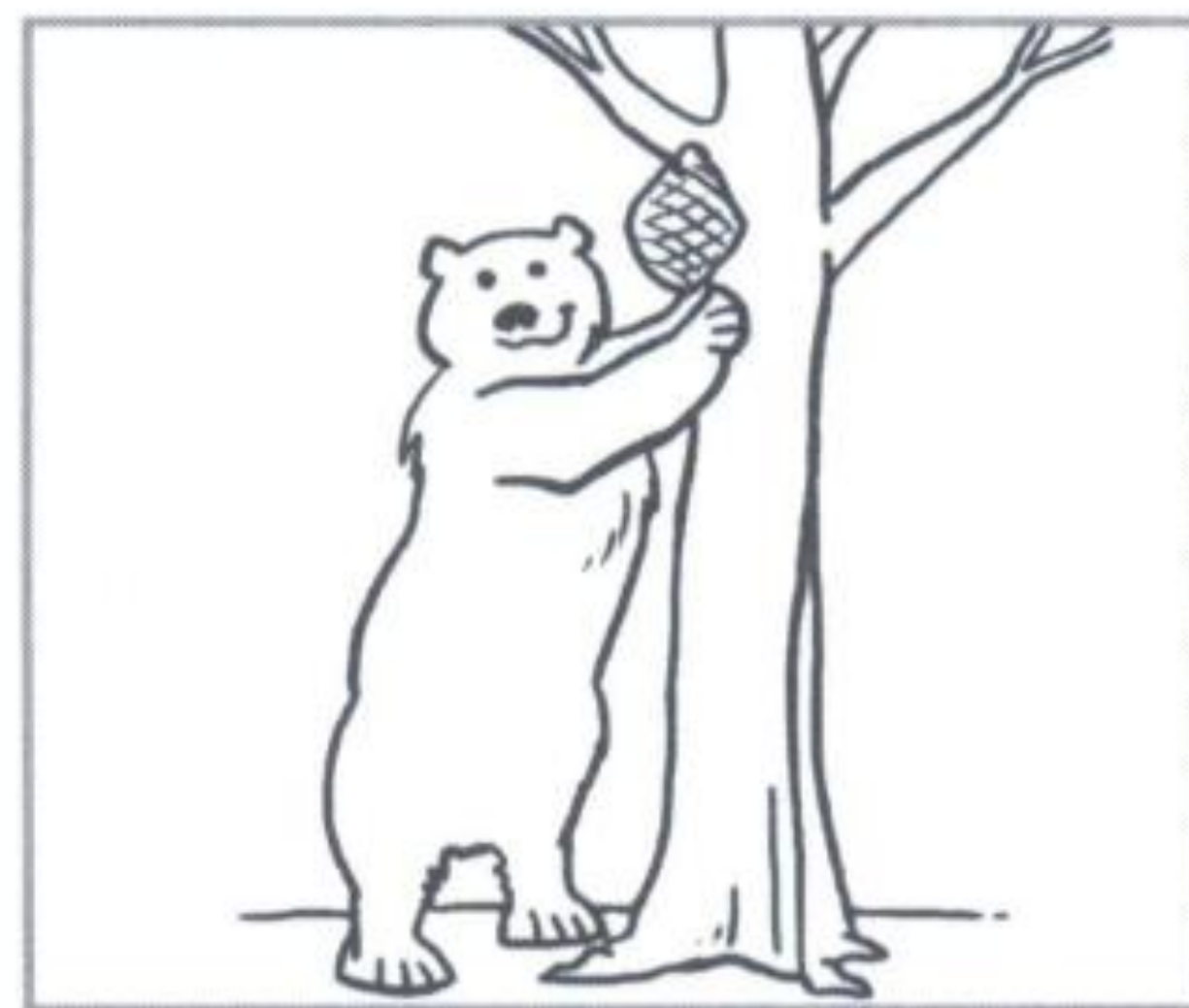

LO

ORSO

L'

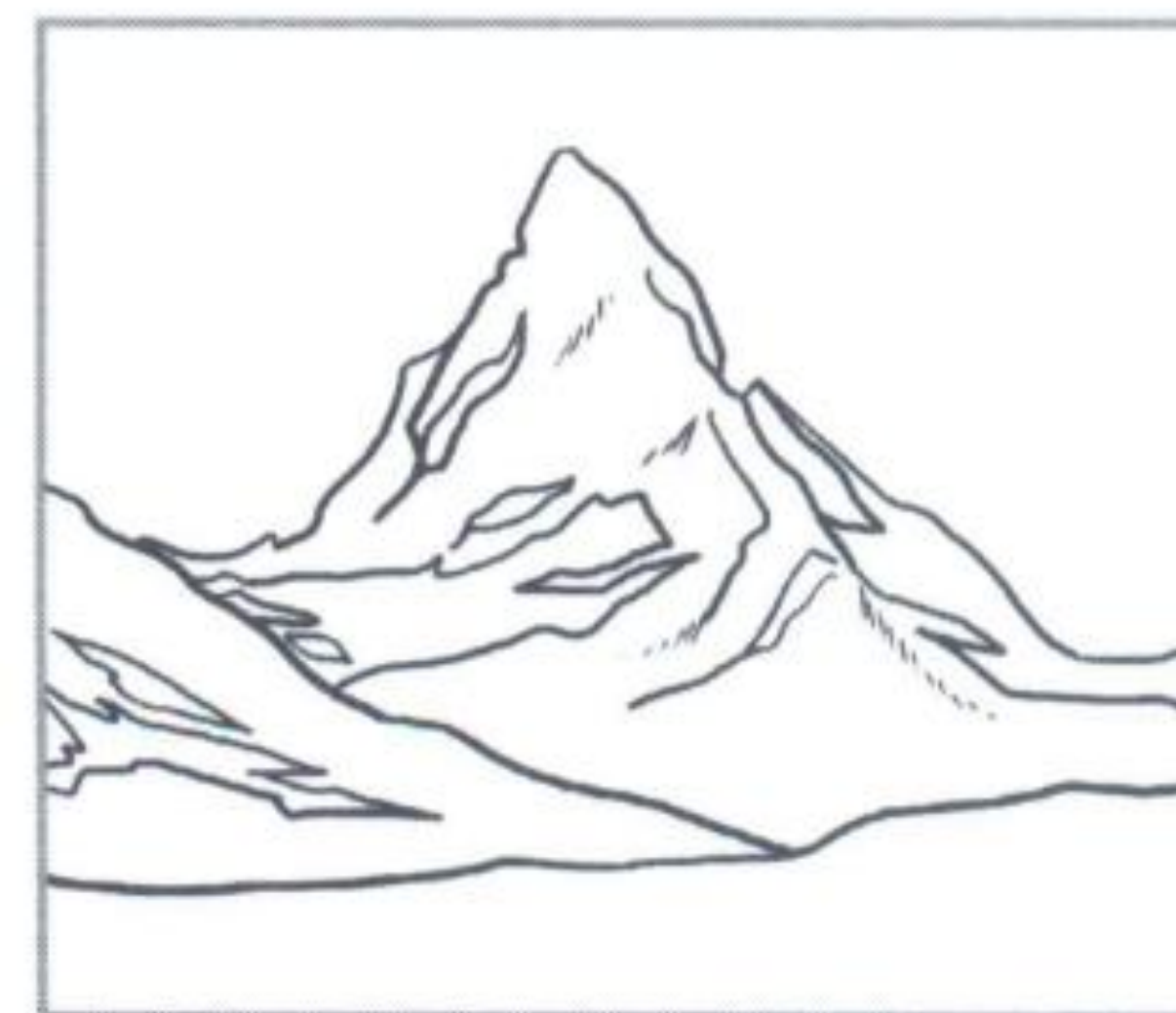

IL

MONTE

LO



LO

OSSO

L'

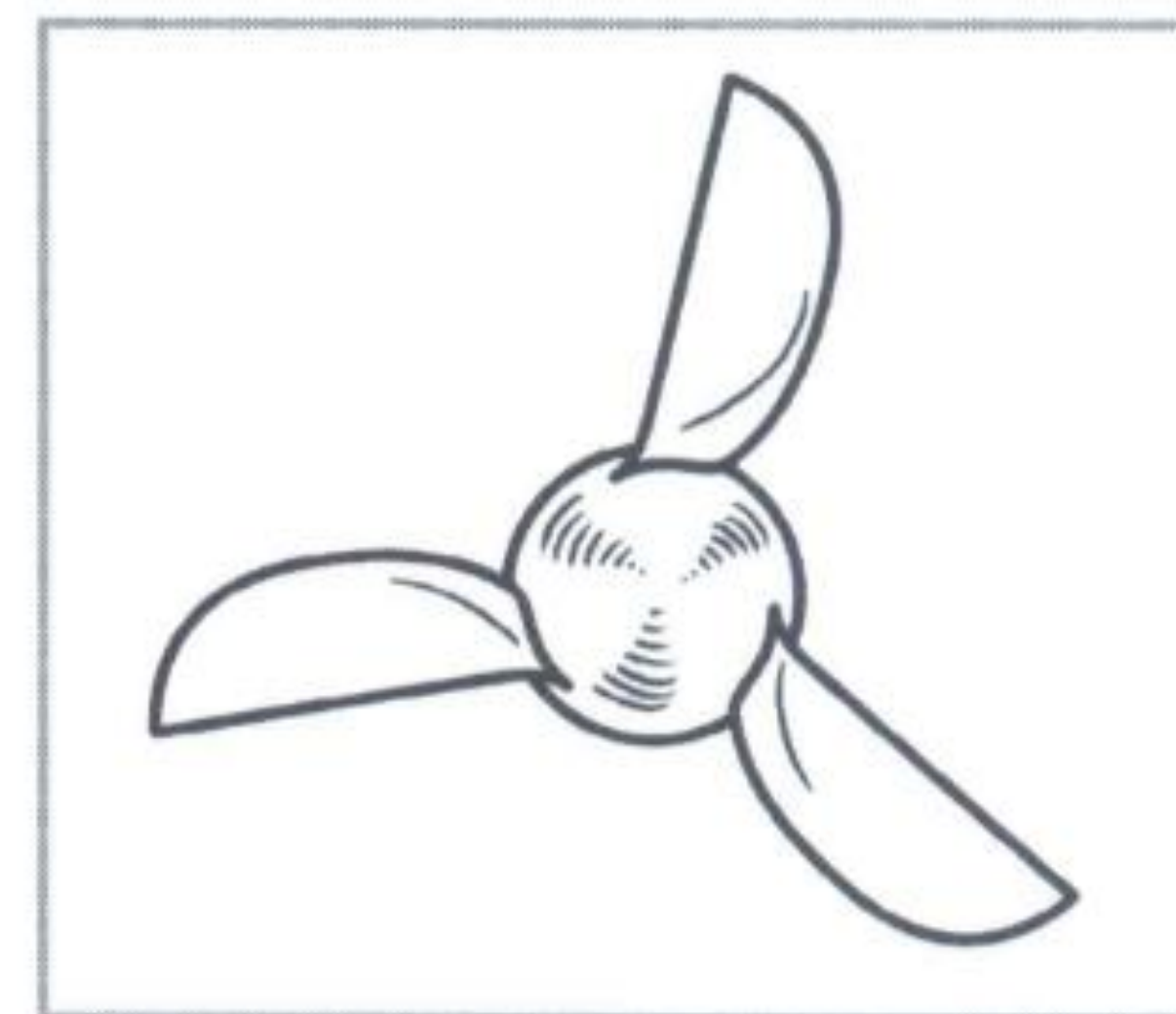

L'

ELICA

LA

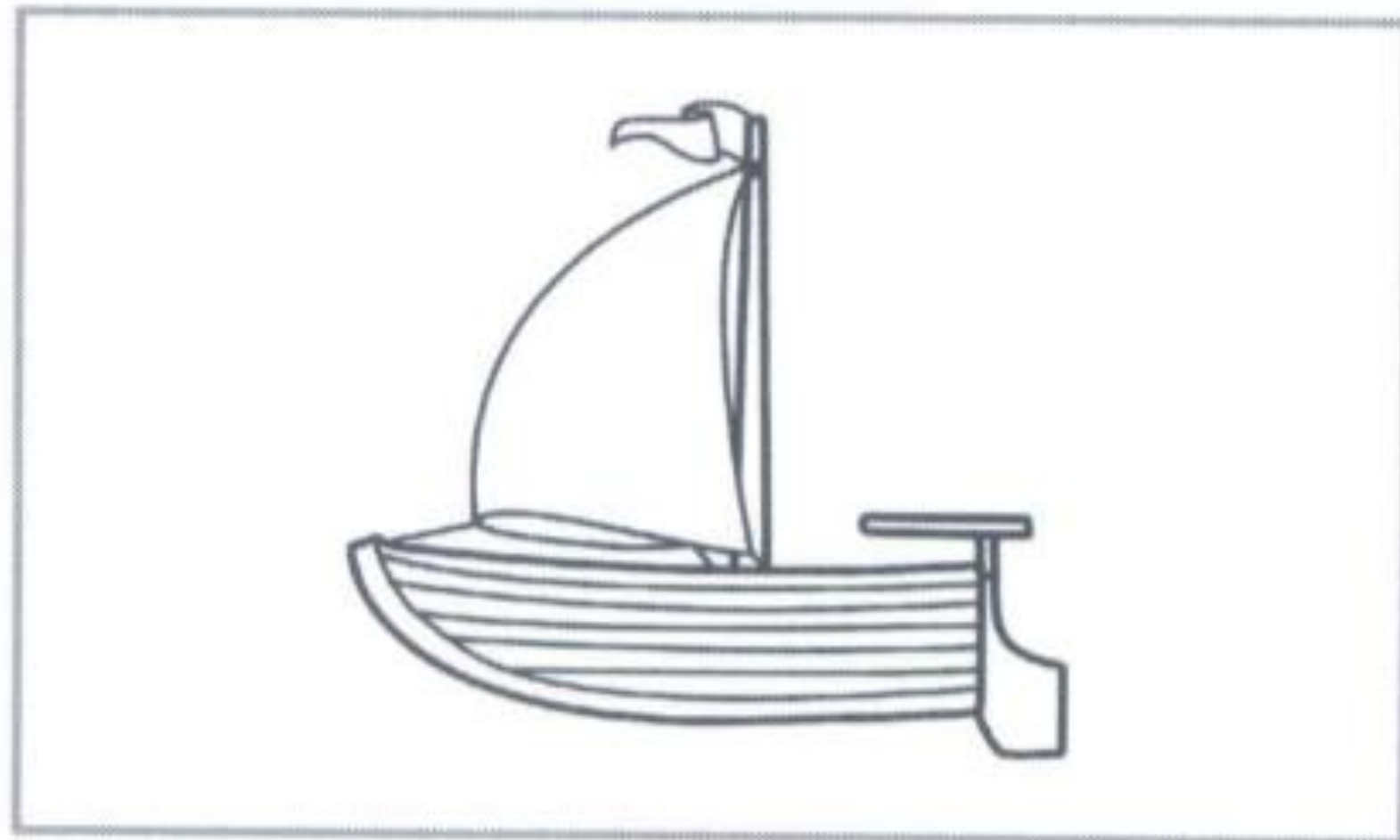

**BARCA**

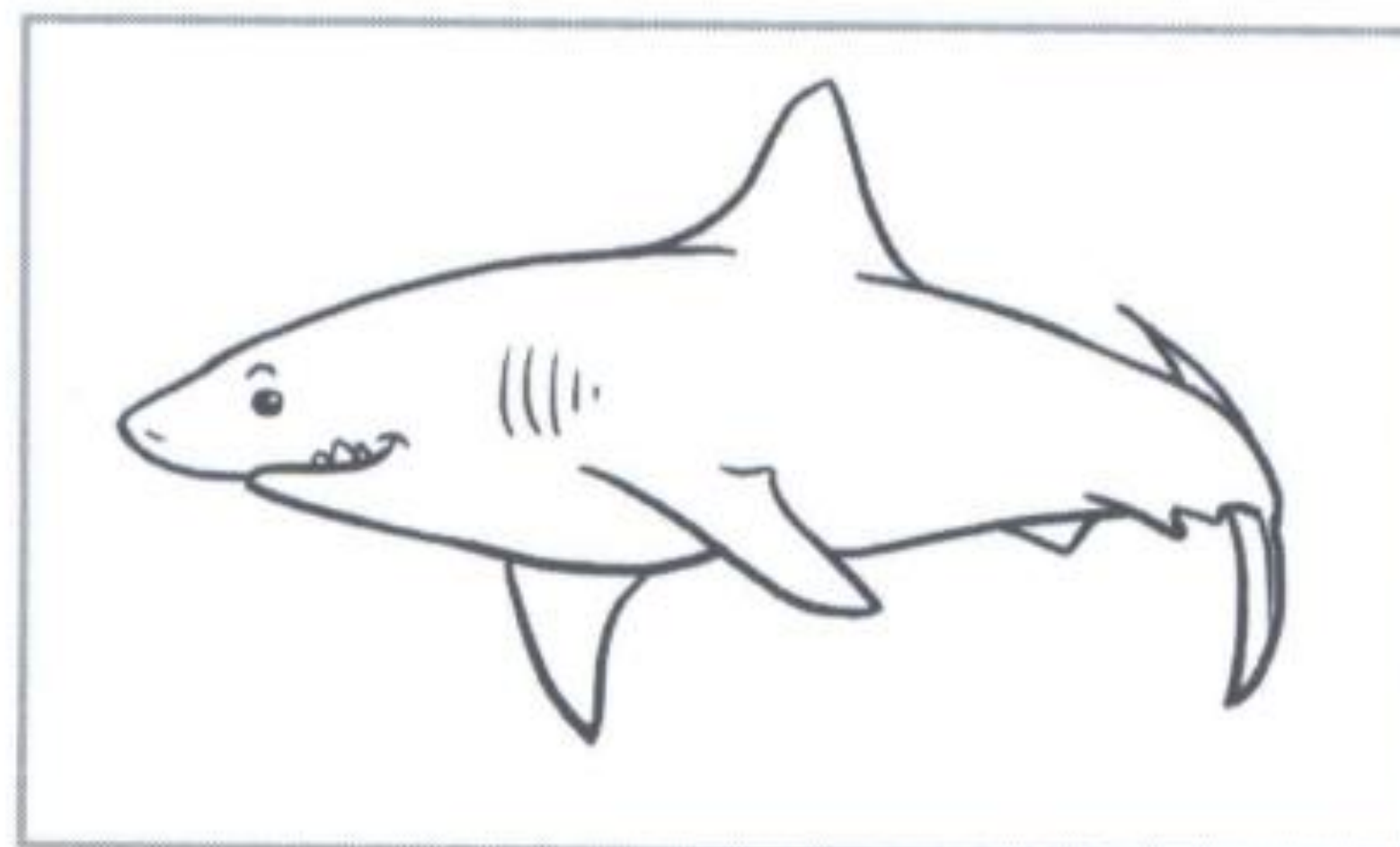

**SQUALO**

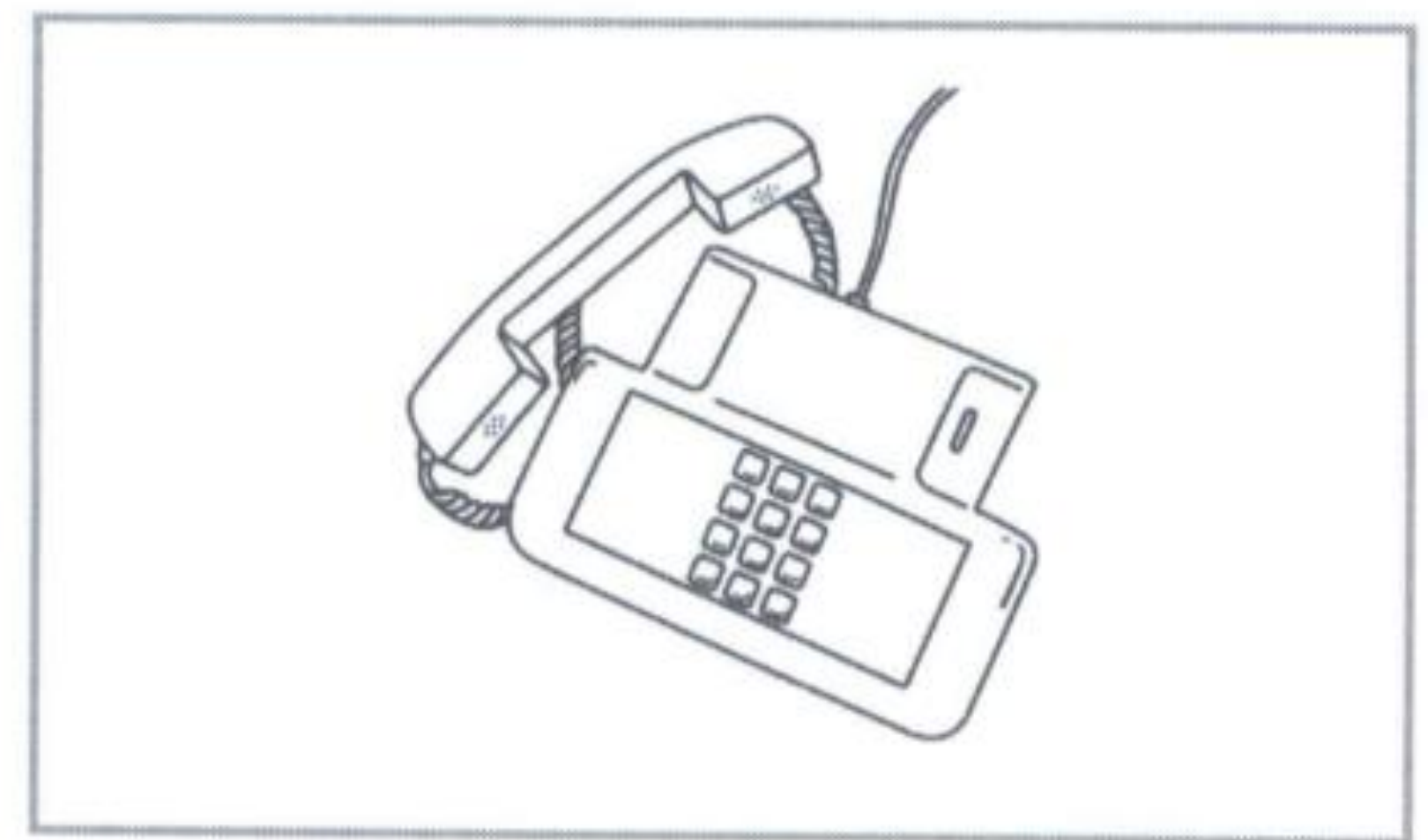

**TELEFONO**

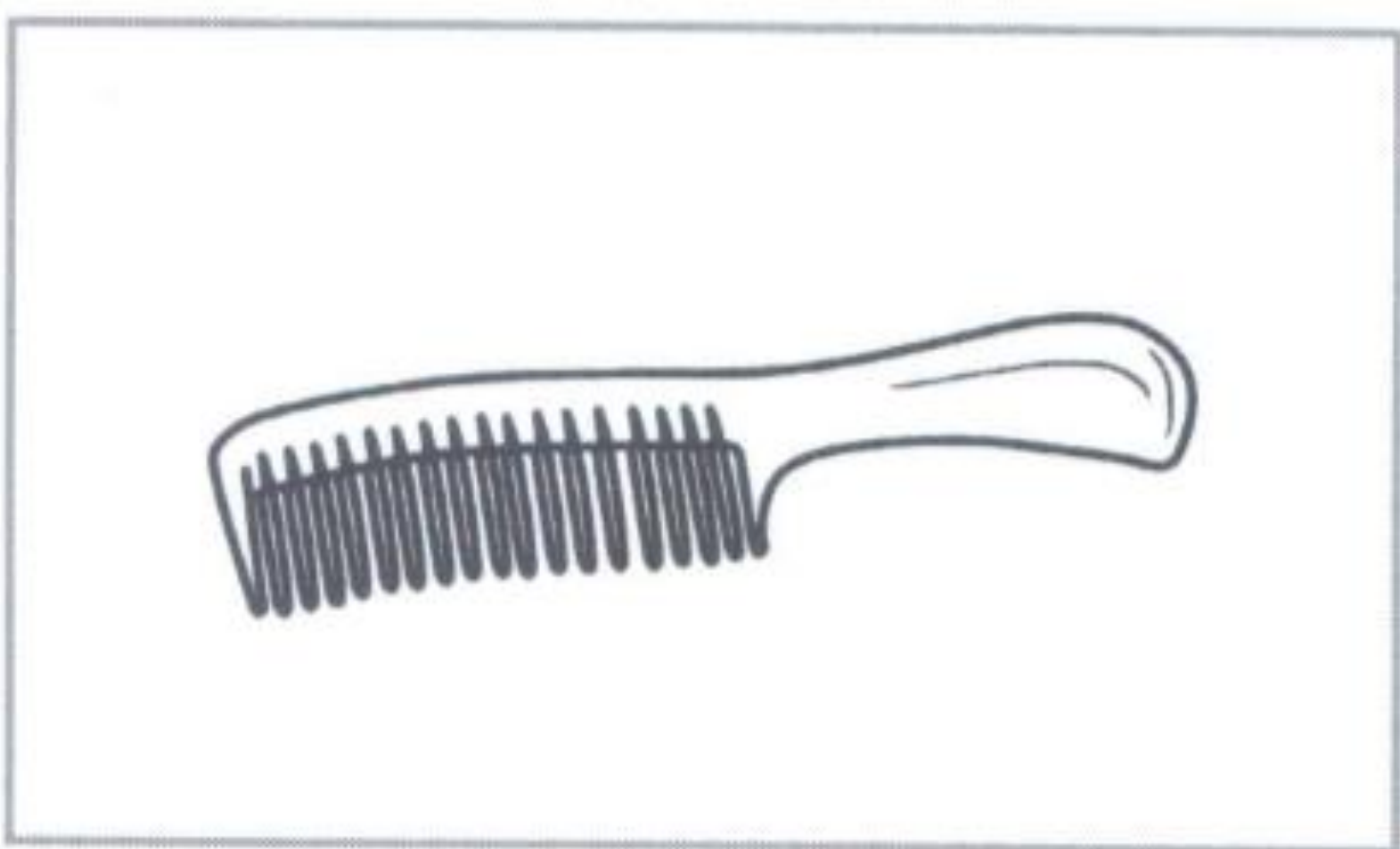

**PETTINE**

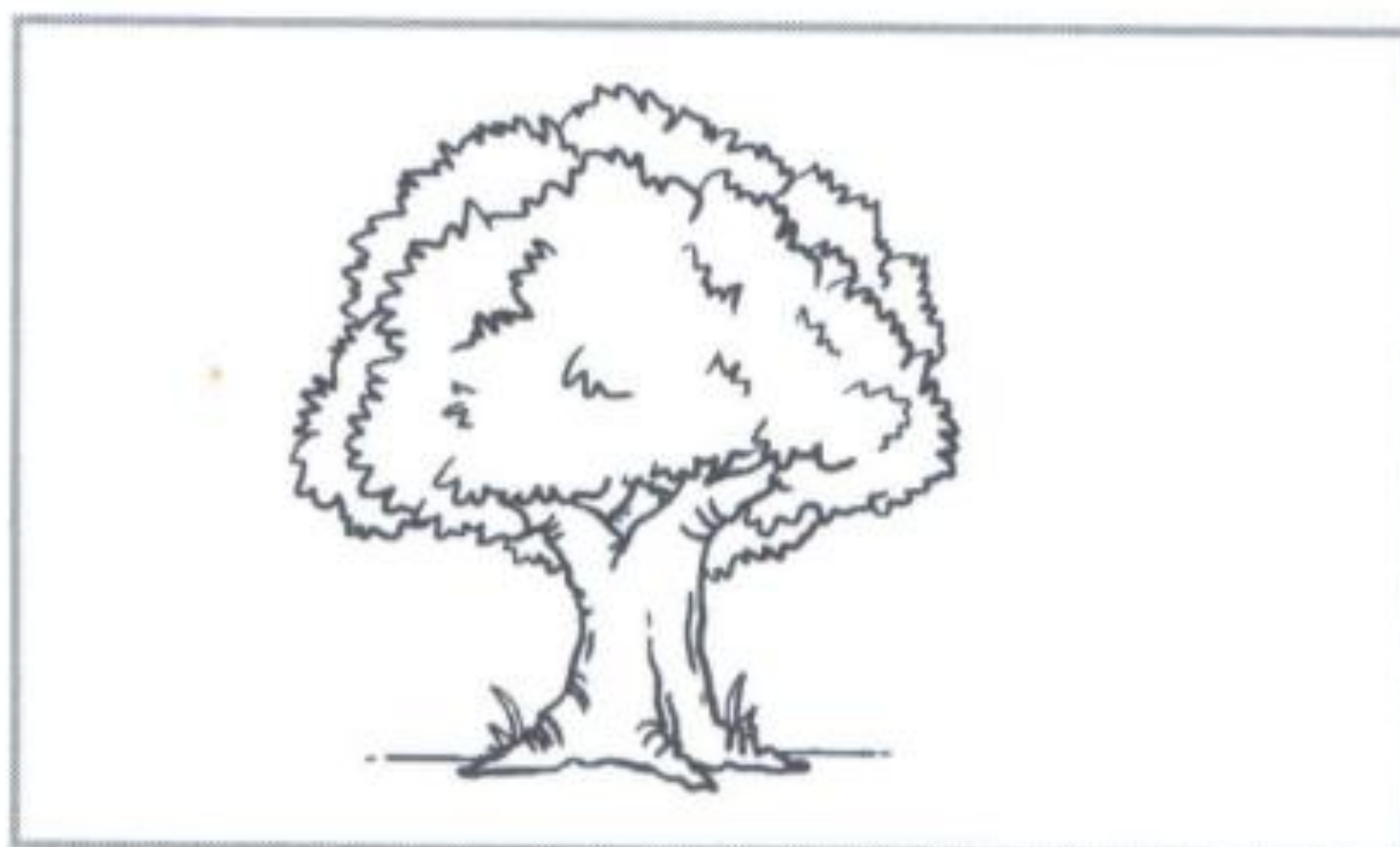

**ALBERO**

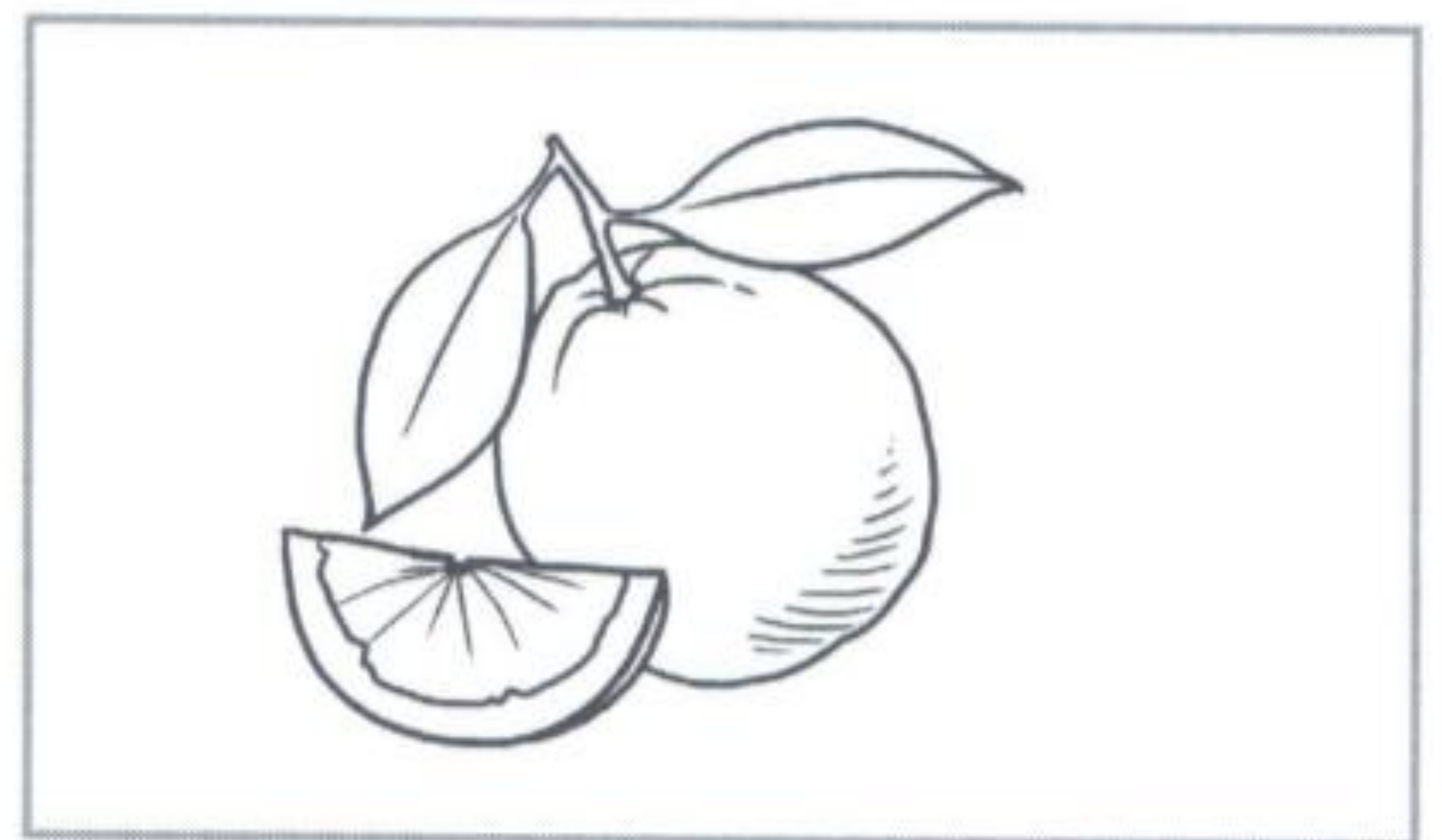

**ARANCIA**

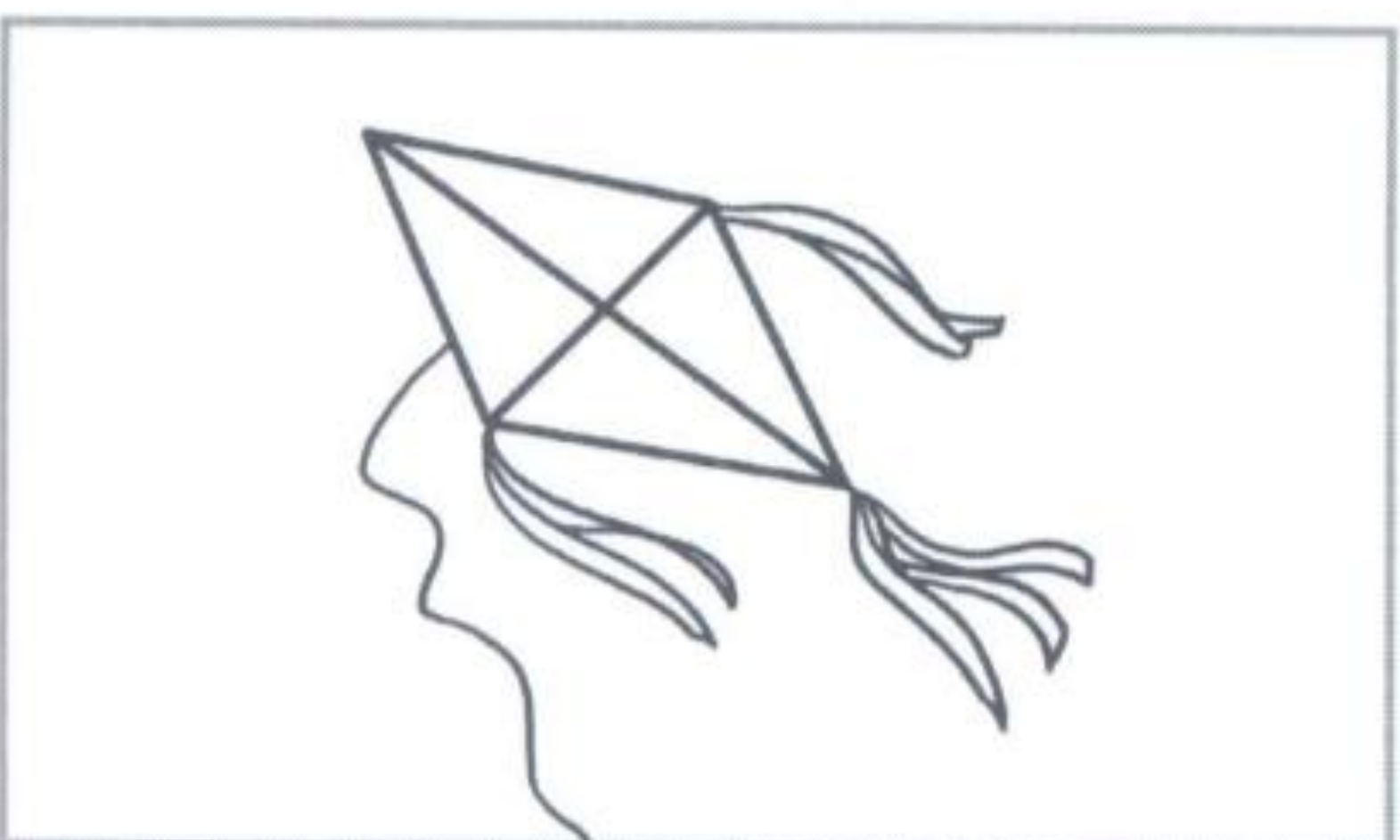

**AQUILONE**



**SCOIATTOLO**



**SPECCHIO**

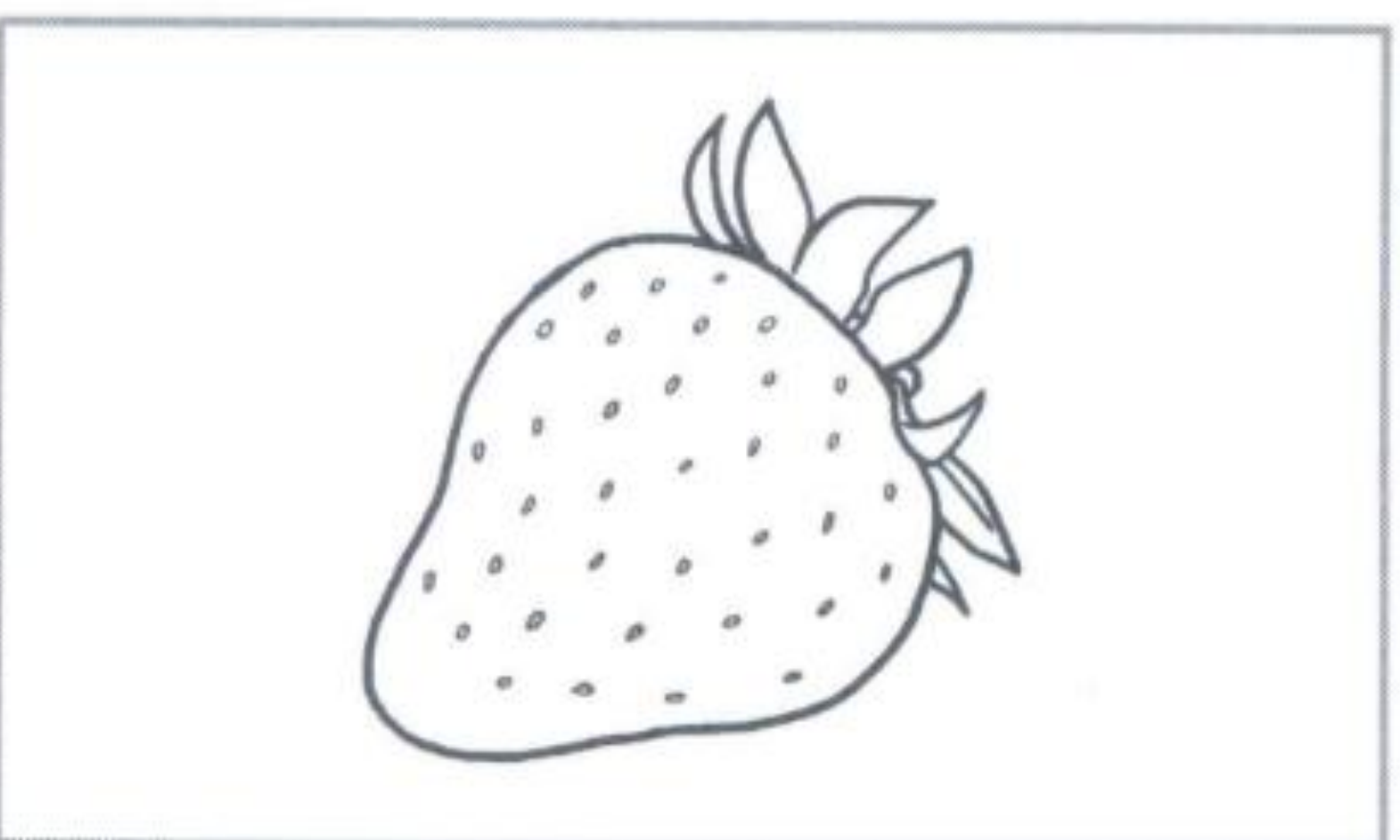

**FRAGOLA**

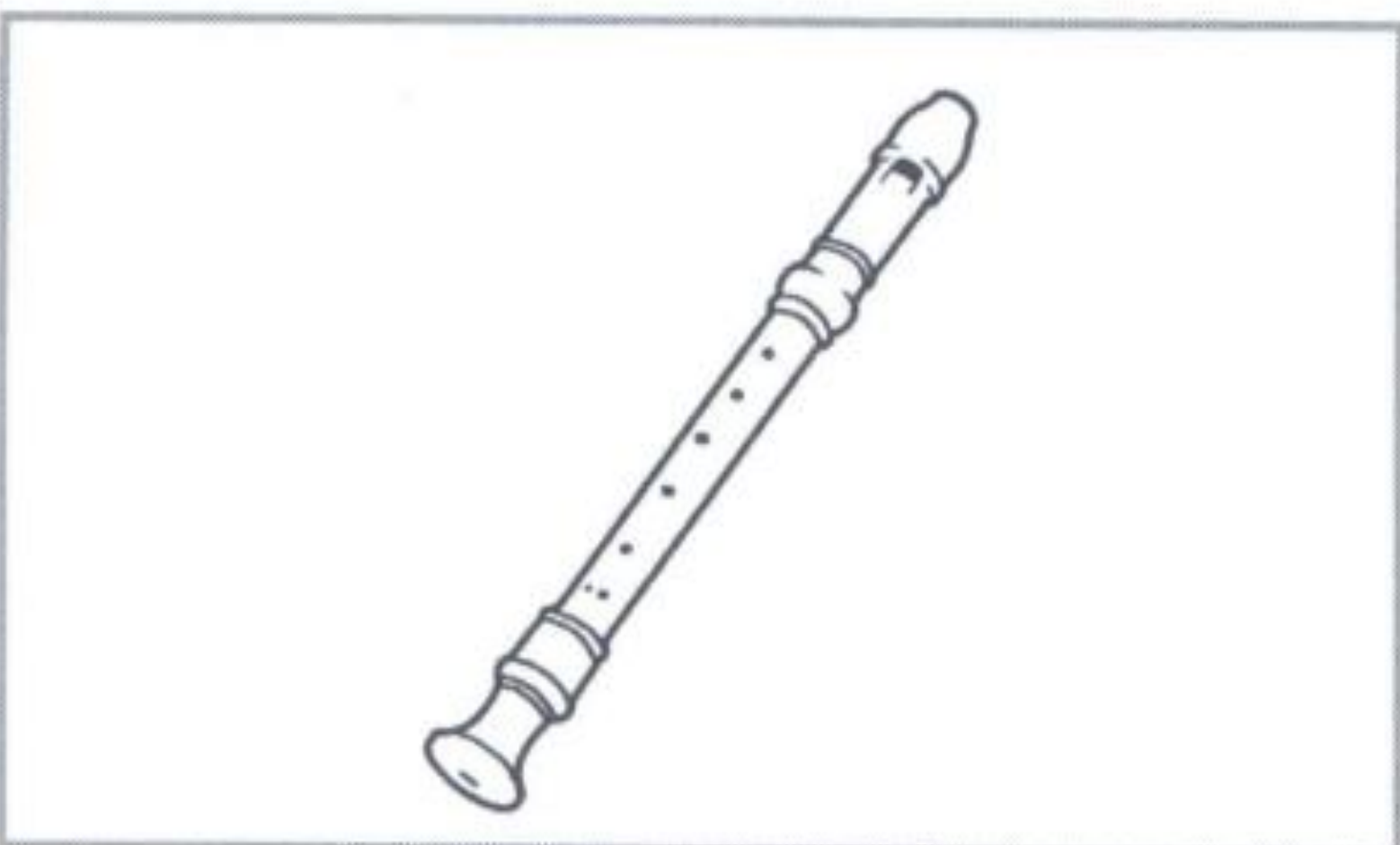

**FLAUTO**



**PIUMA**



**TAMBURO**



**ZAINO**

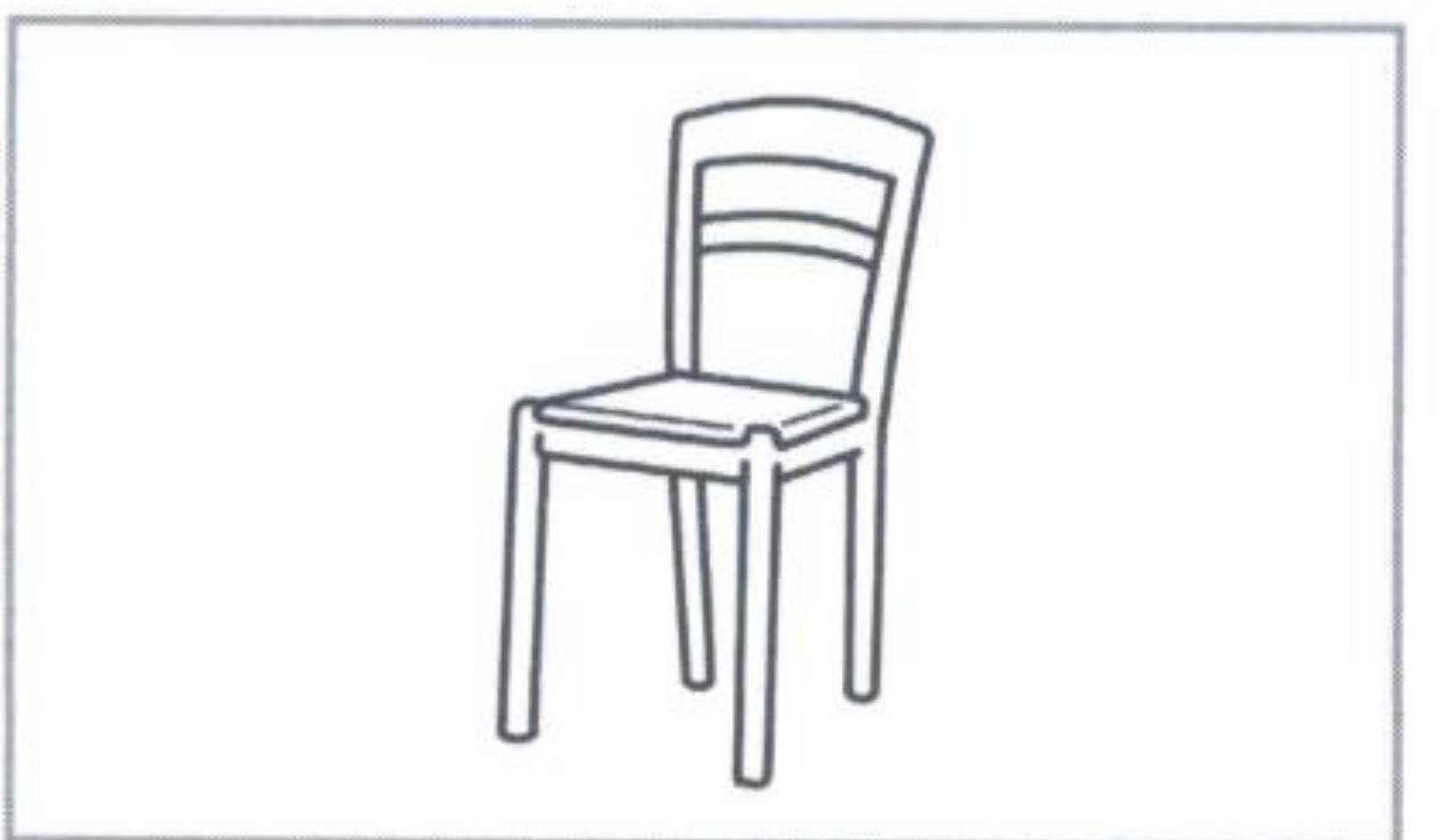

**SEDIA**



OSSERVA, LEGGI E RIPASSA L'ARTICOLO DETERMINATIVO GIUSTO



I

BISCOTTI

GLI



LE

OLIVE

I

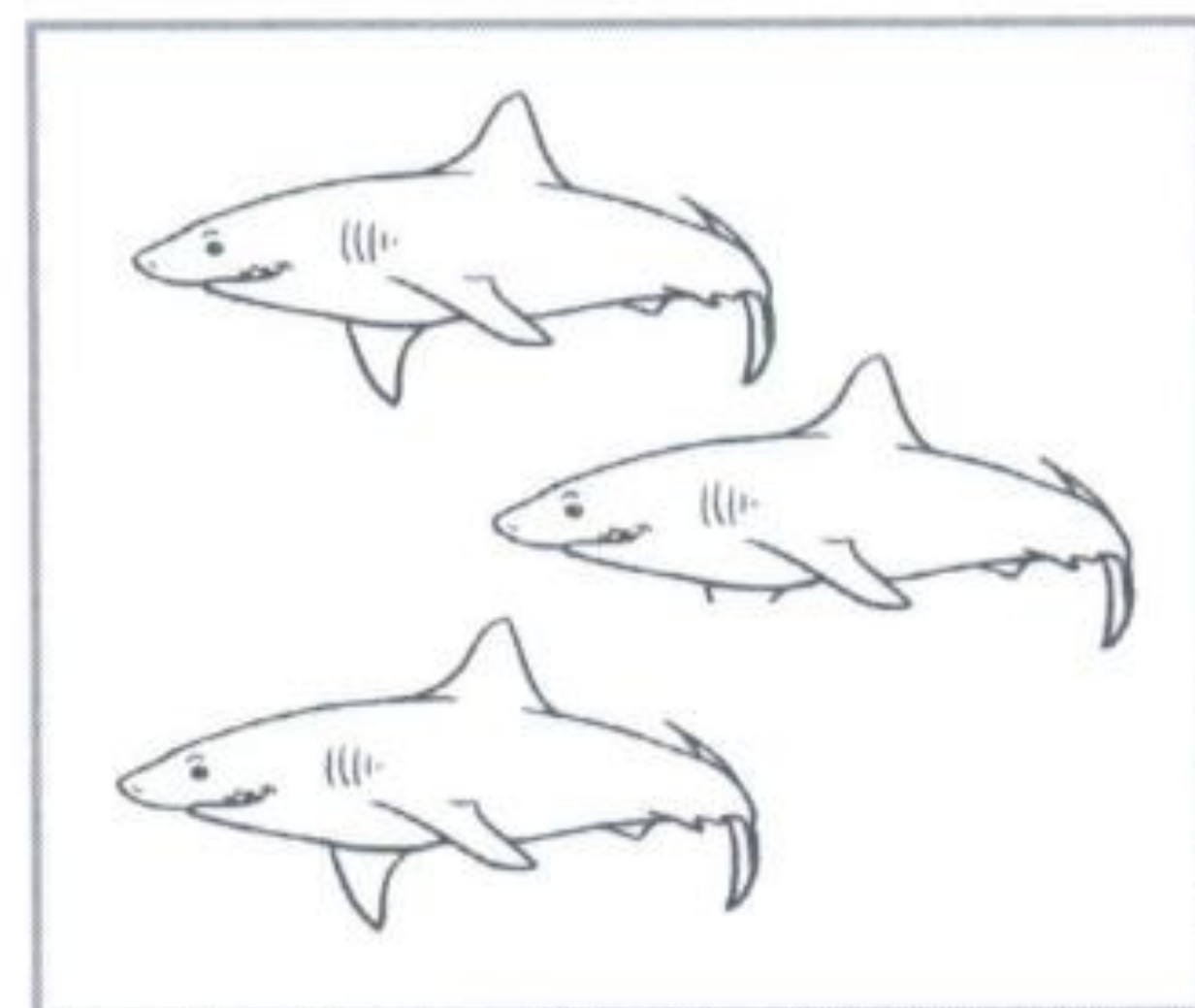

GLI

SQUALI

I

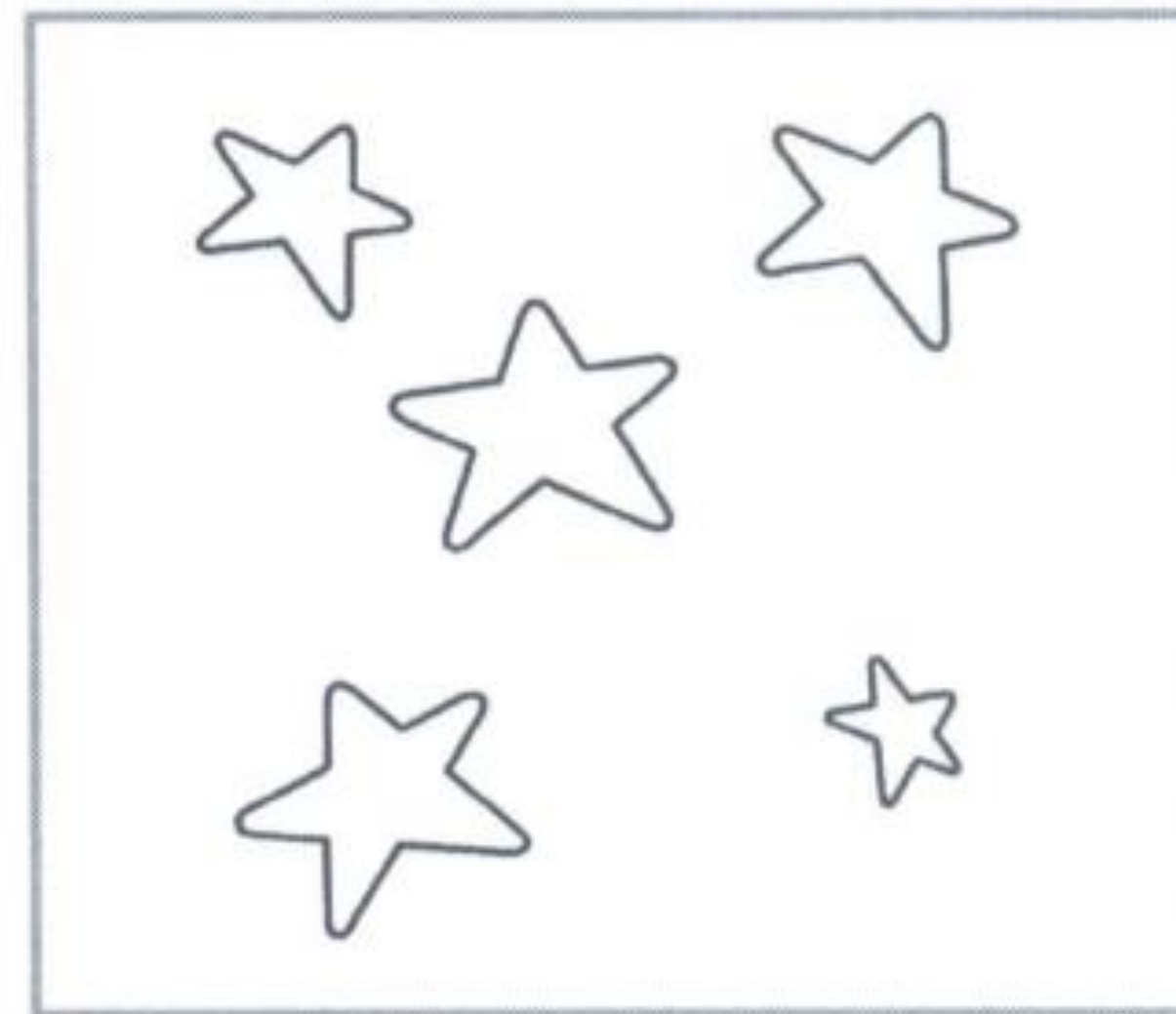

LE

STELLE

I

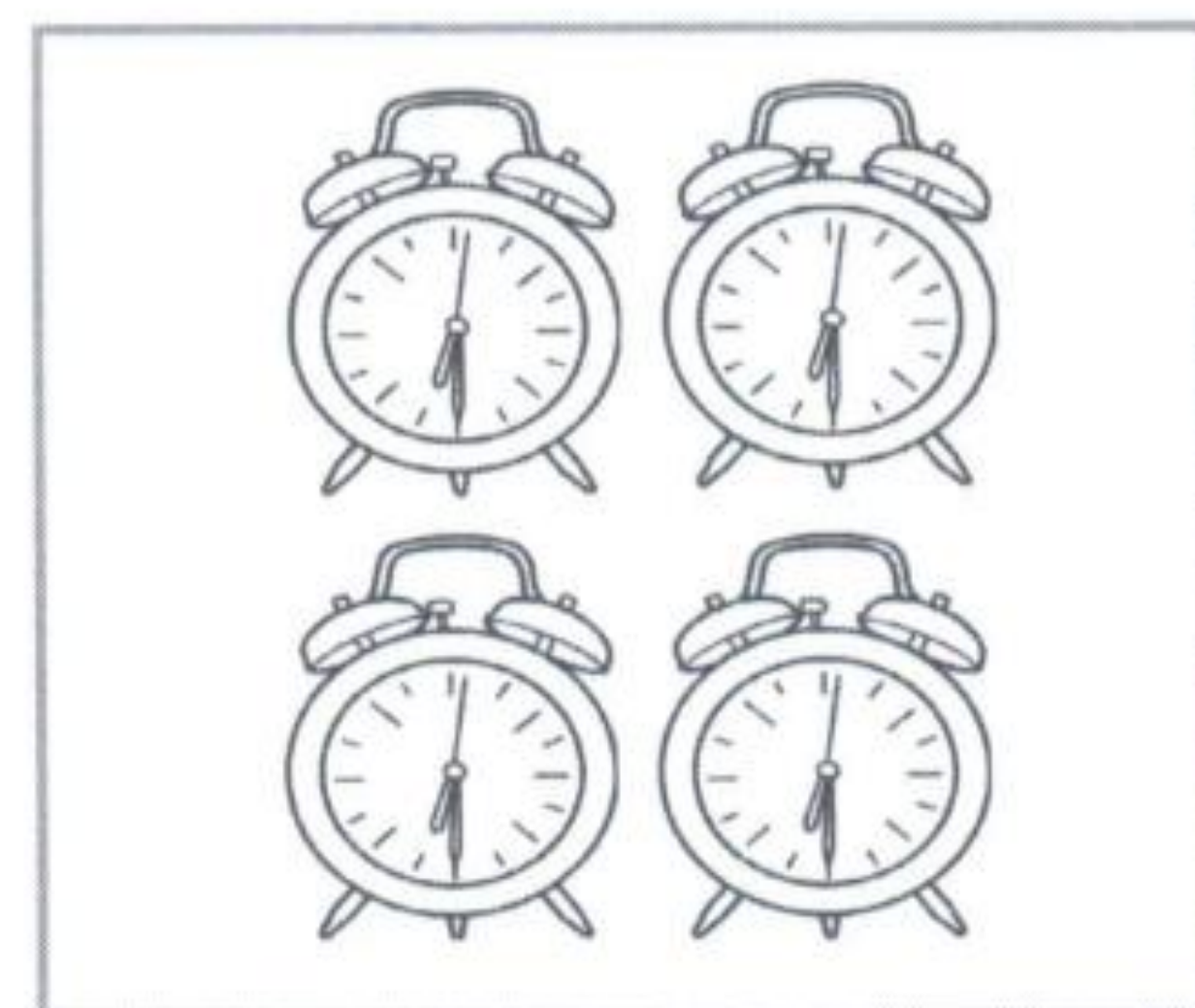

GLI

SVEGLIE

LE

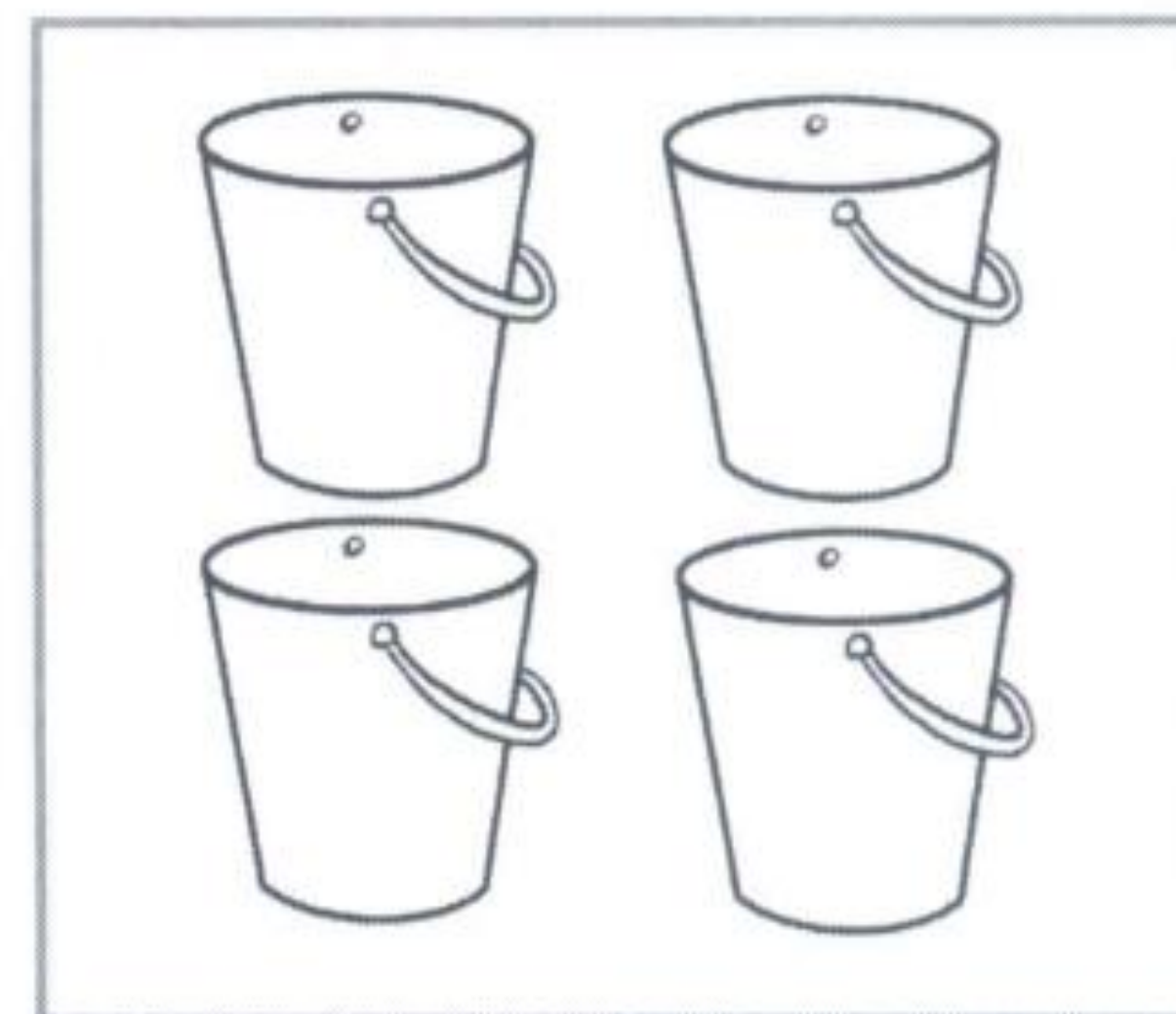

GLI

SECCHI

I



GLI

EURO

I

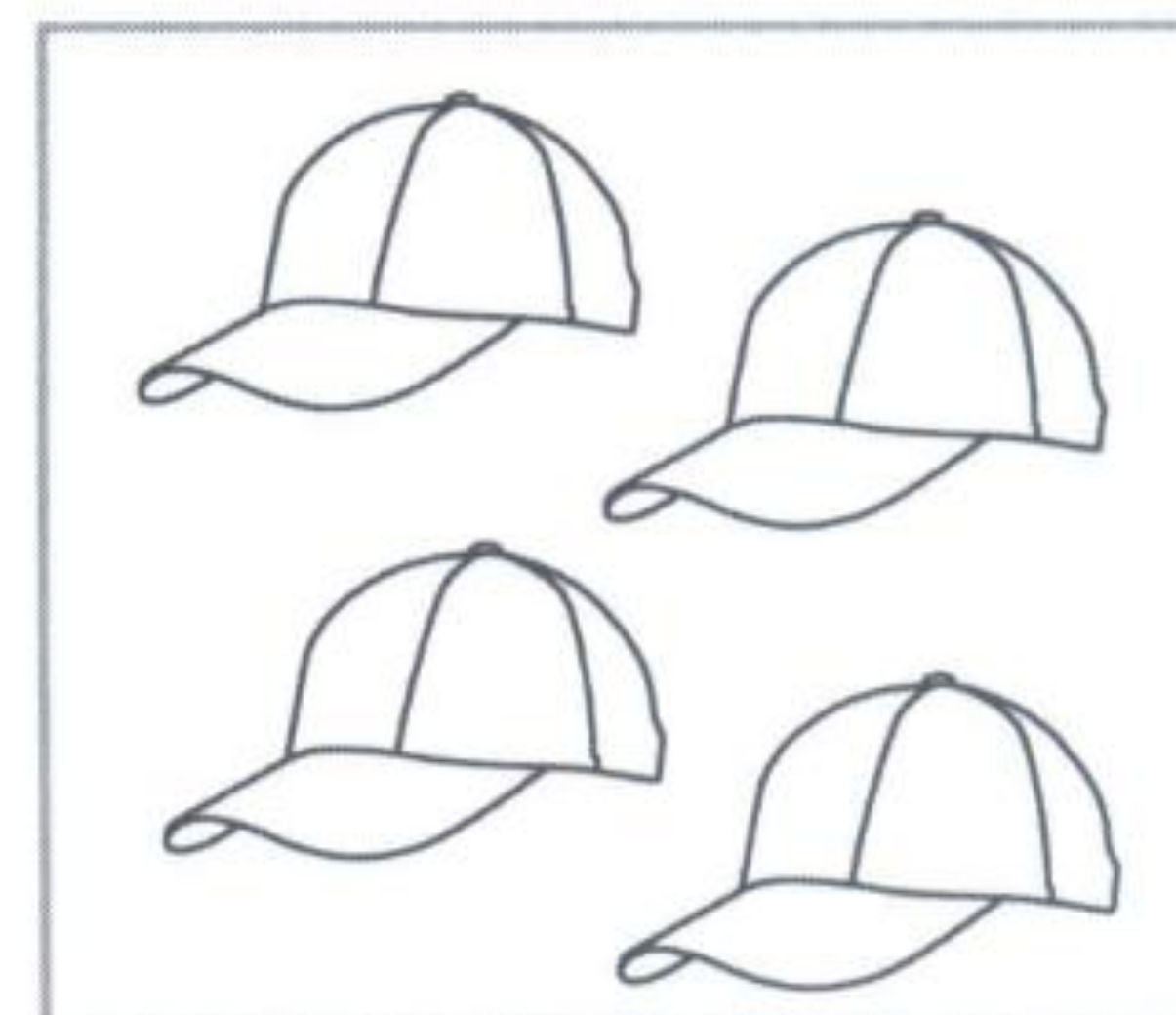

GLI

CAPPELLI

I

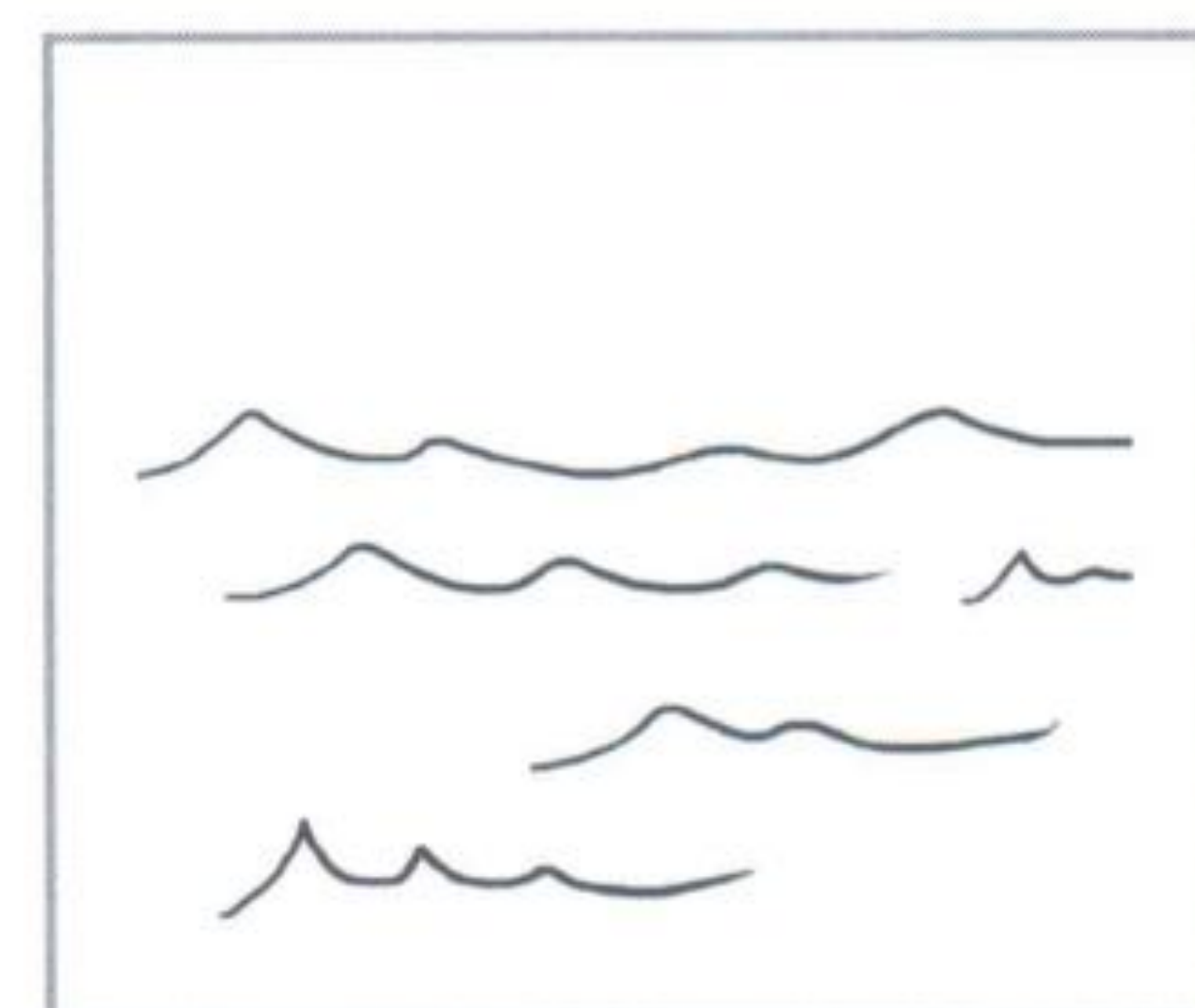

I

ONDE

LE

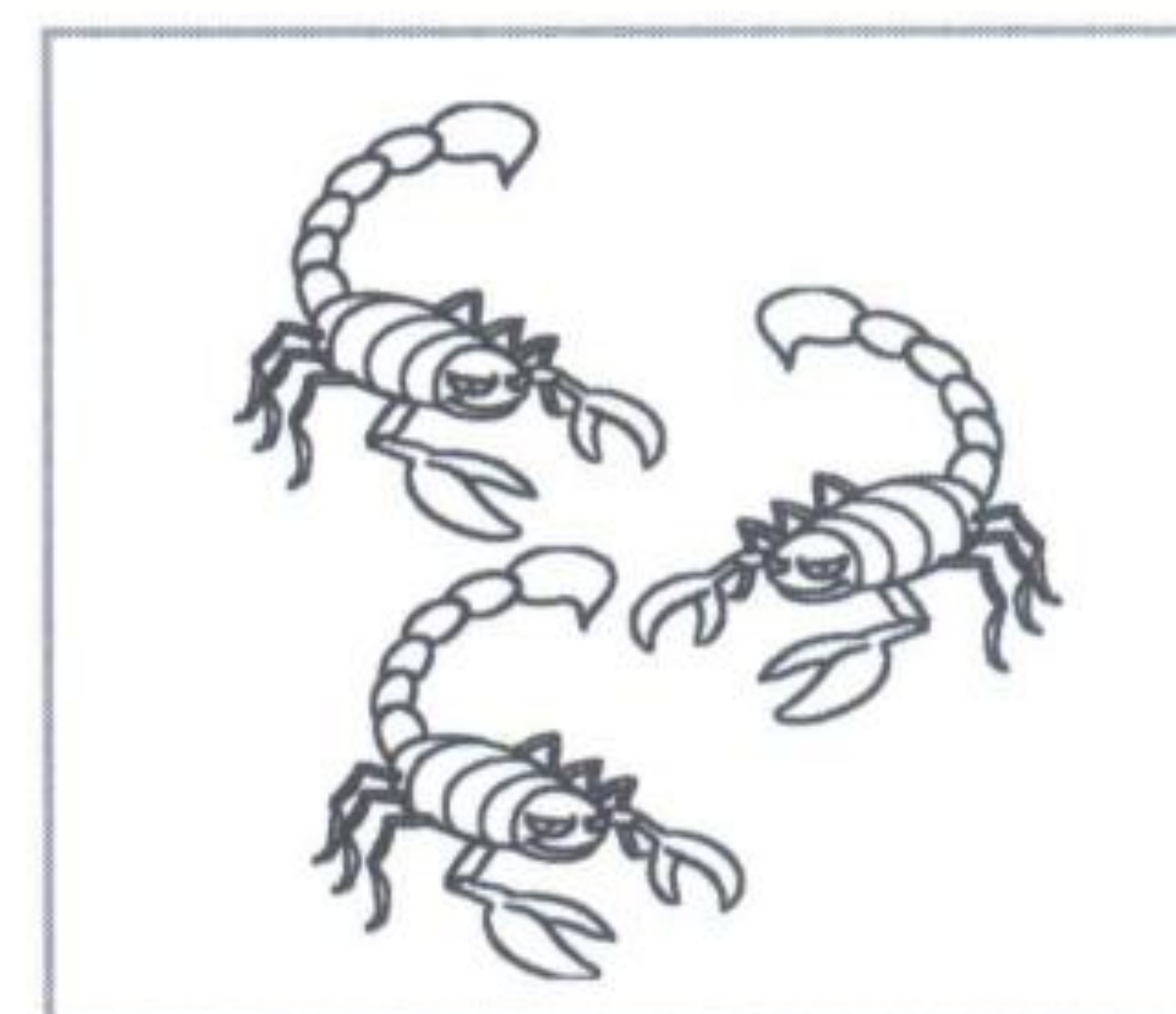

I

SCORPIONI

GLI

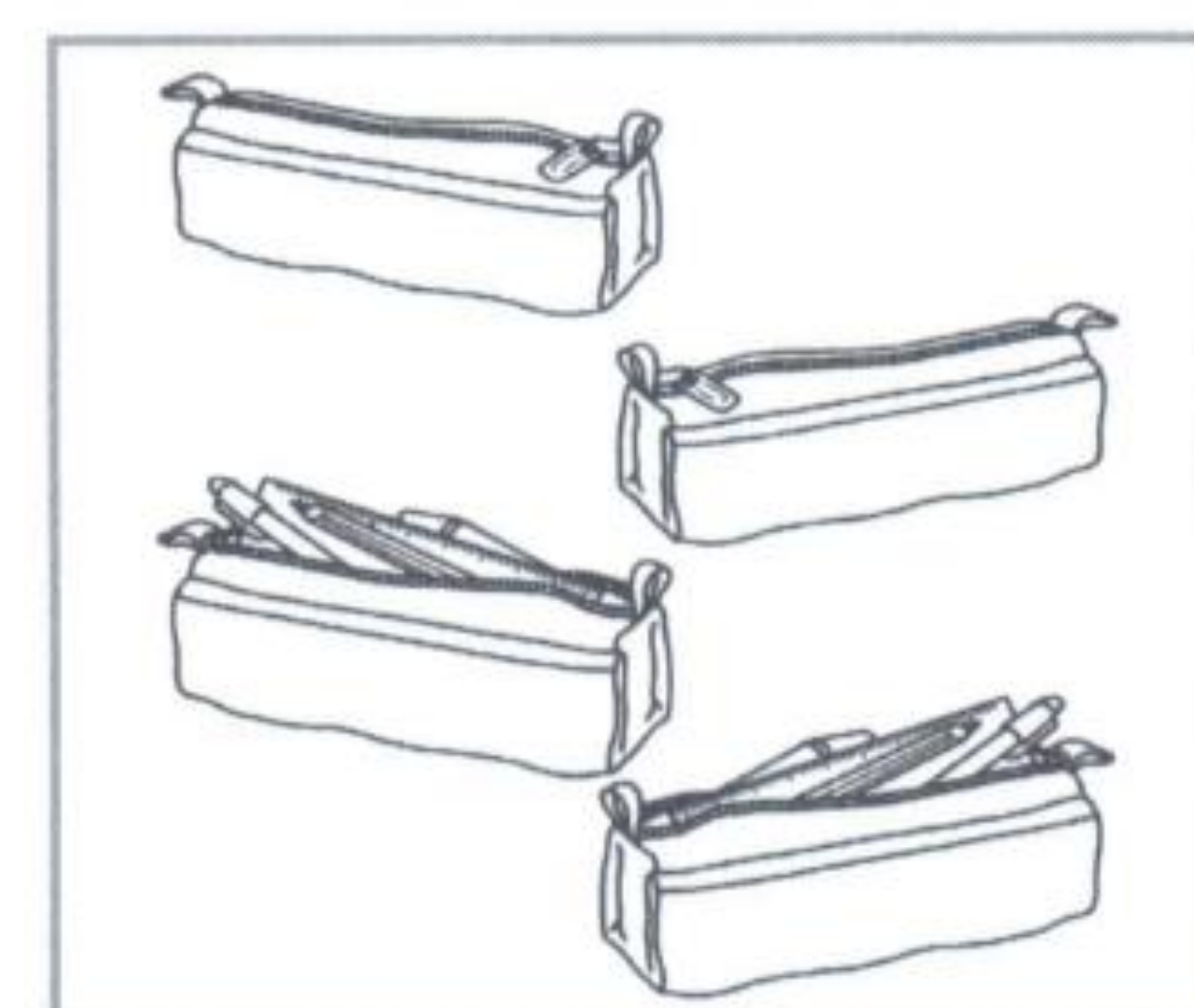

I

ASTUCCI

GLI

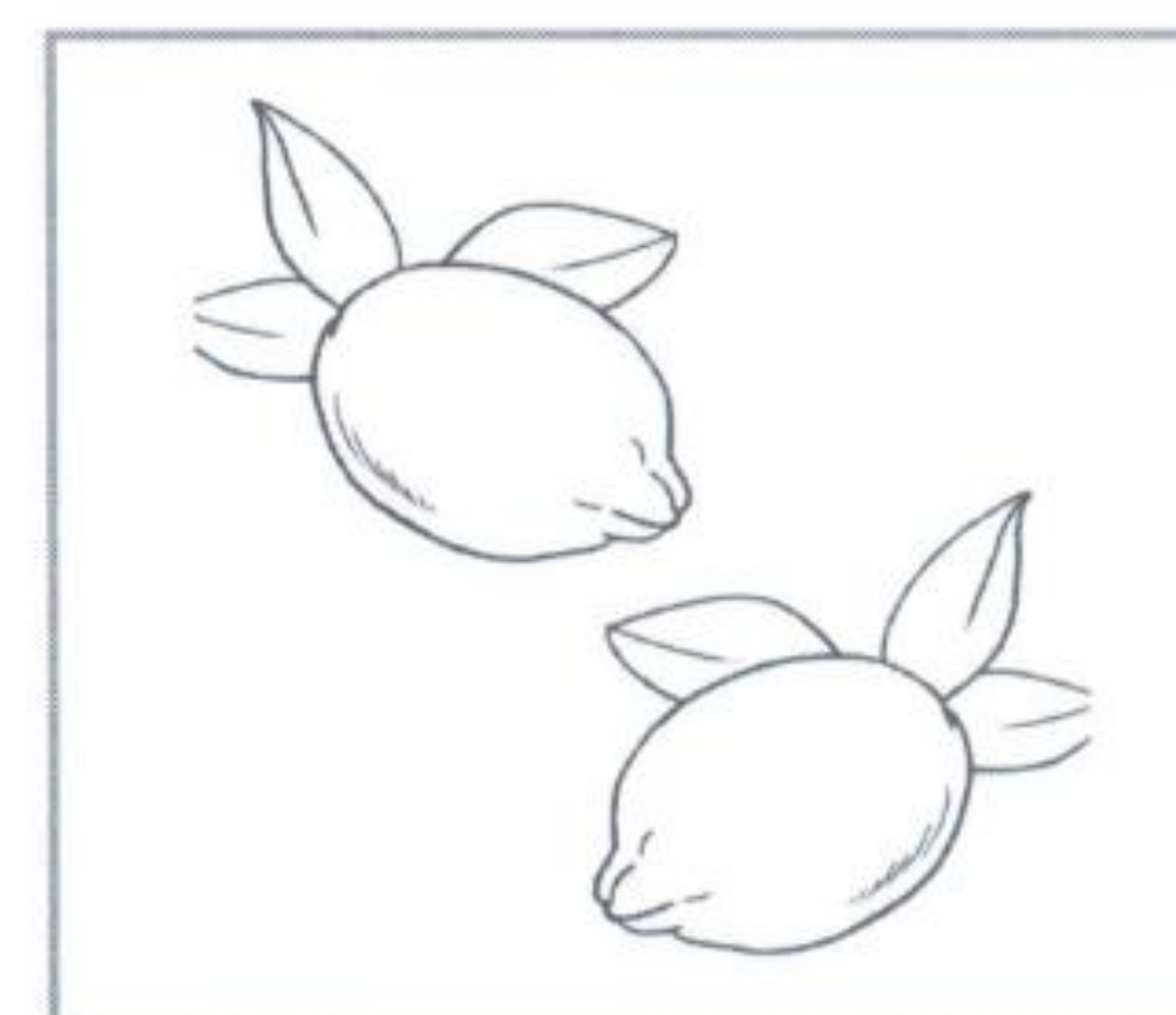

I

LIMONI

GLI

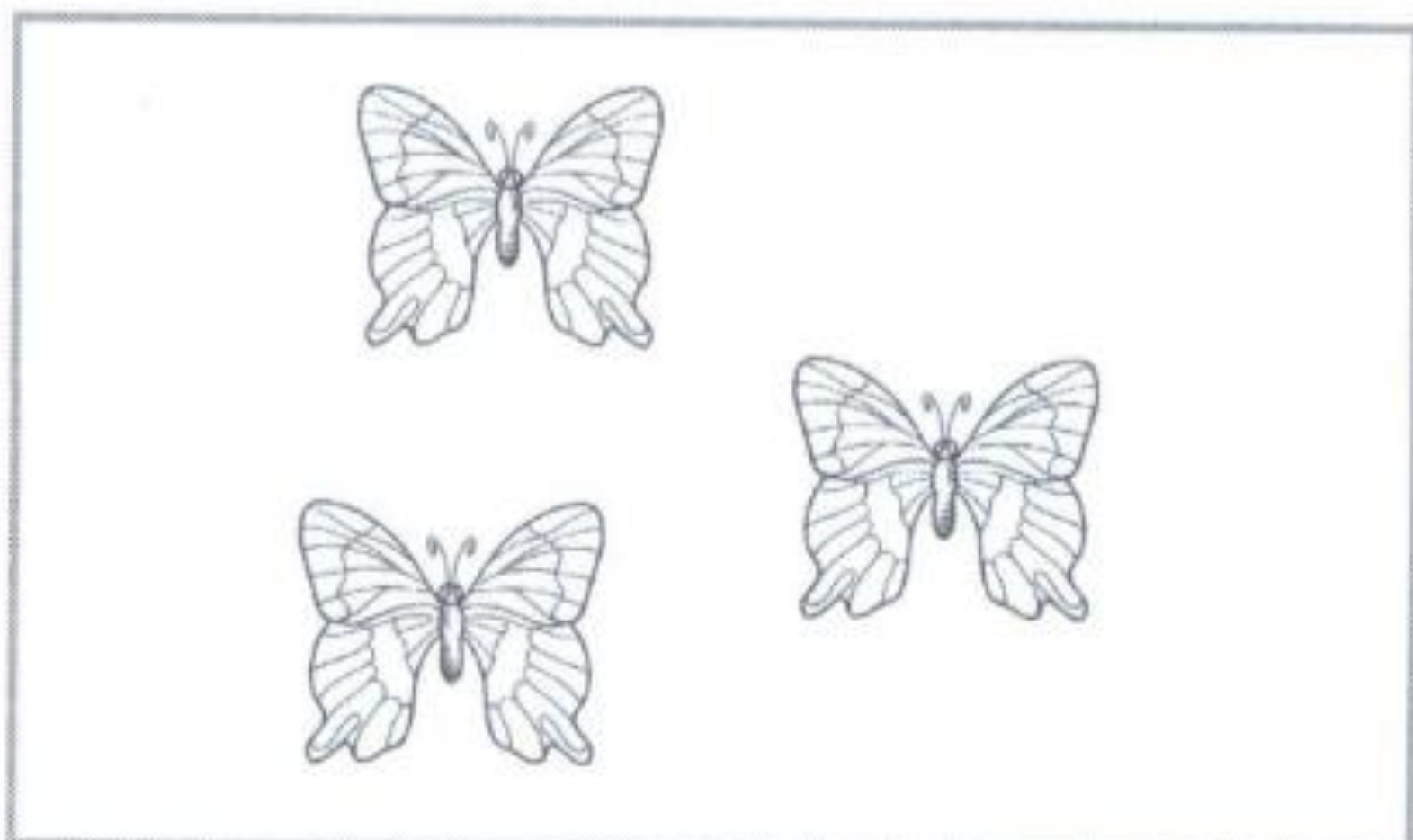

**FARFALLE**

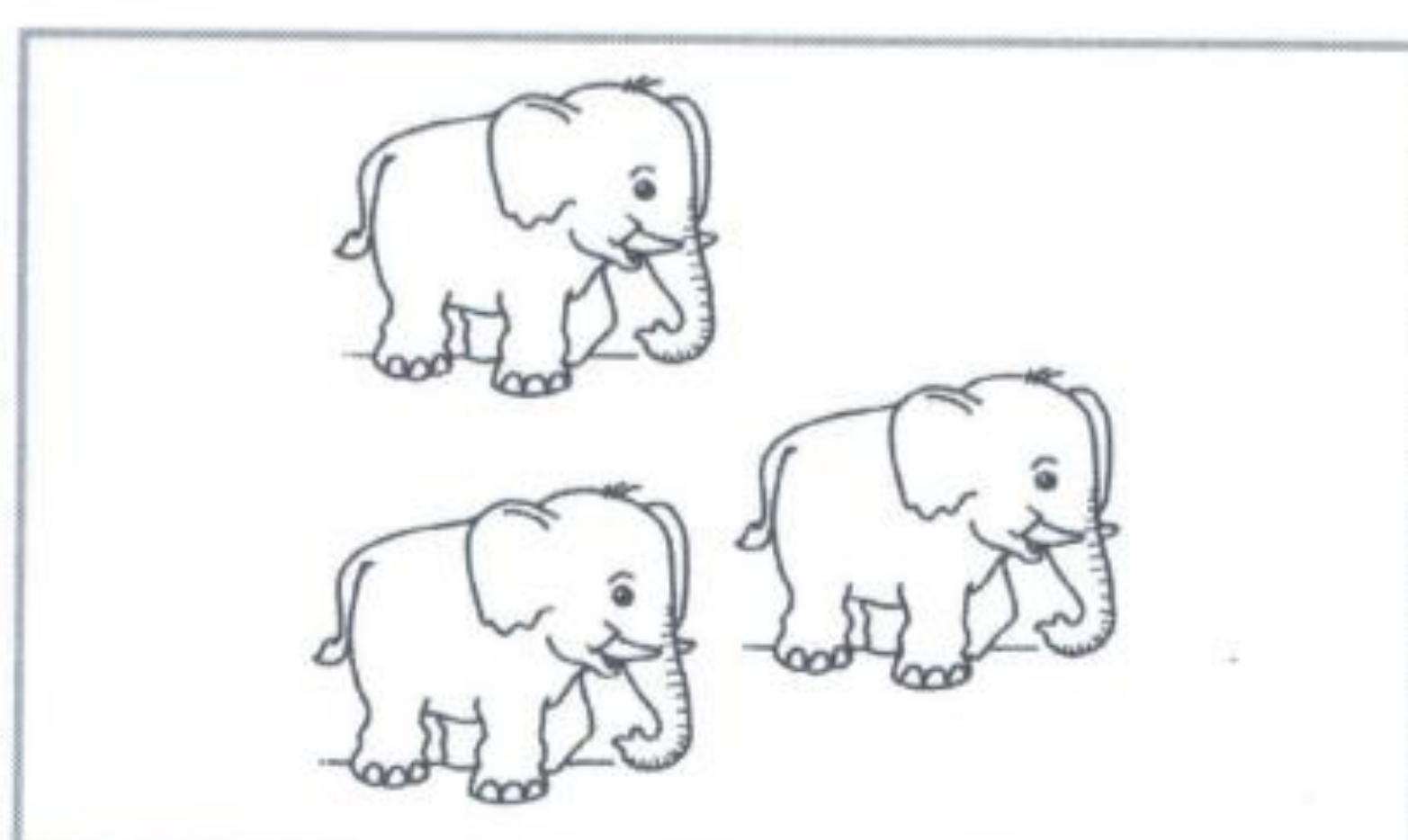

**ELEFANTI**

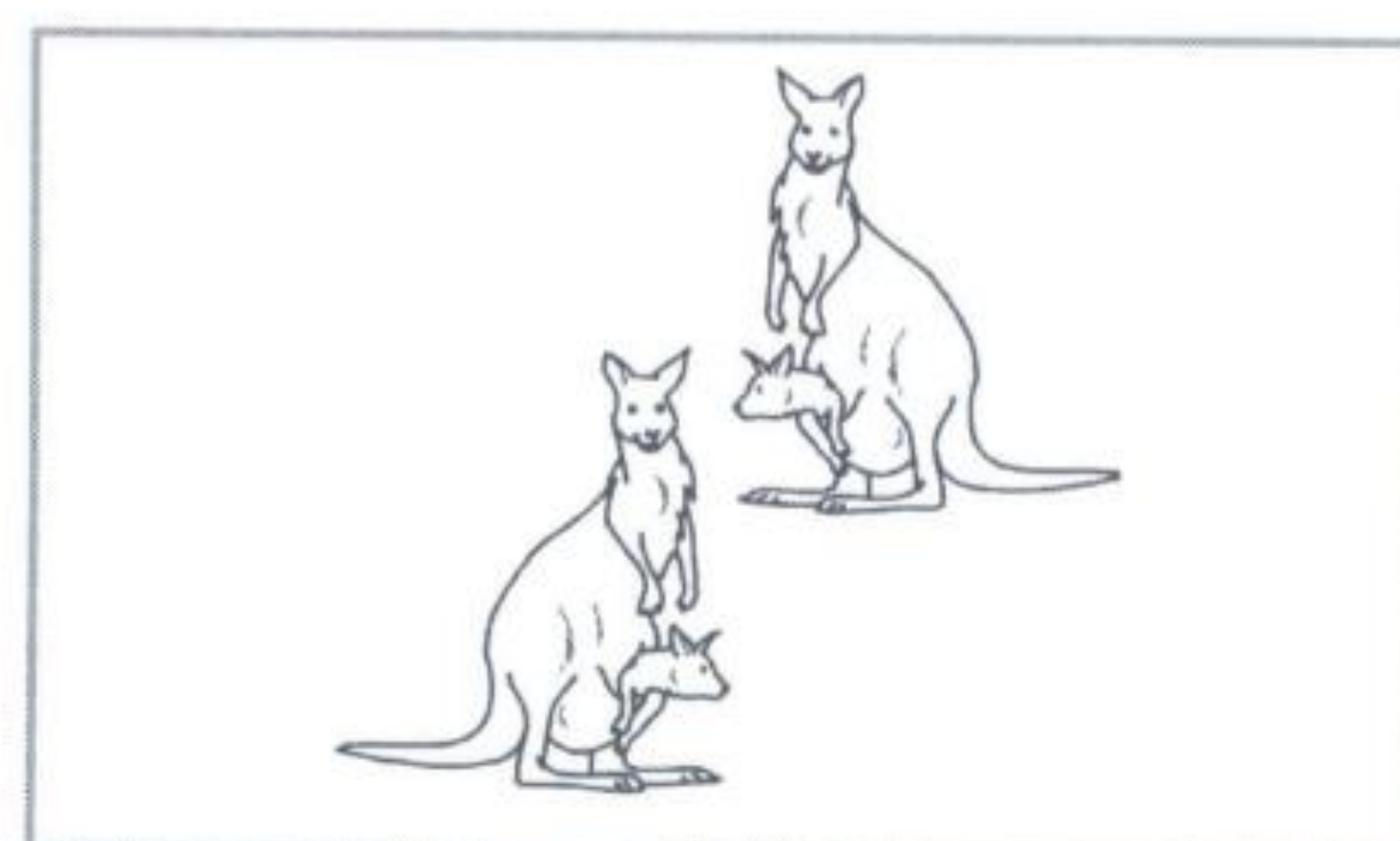

**CANGURI**

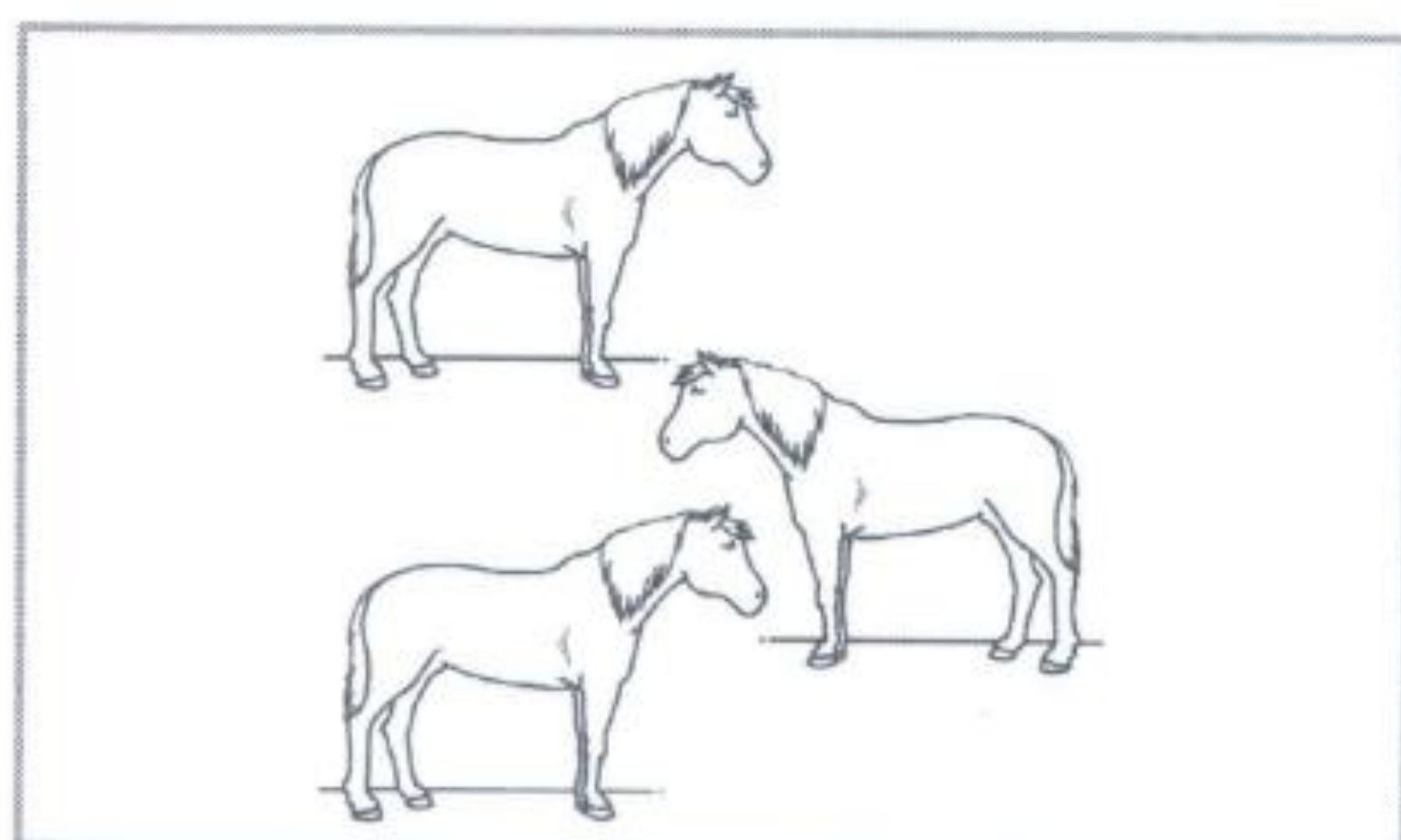

**CAVALLI**

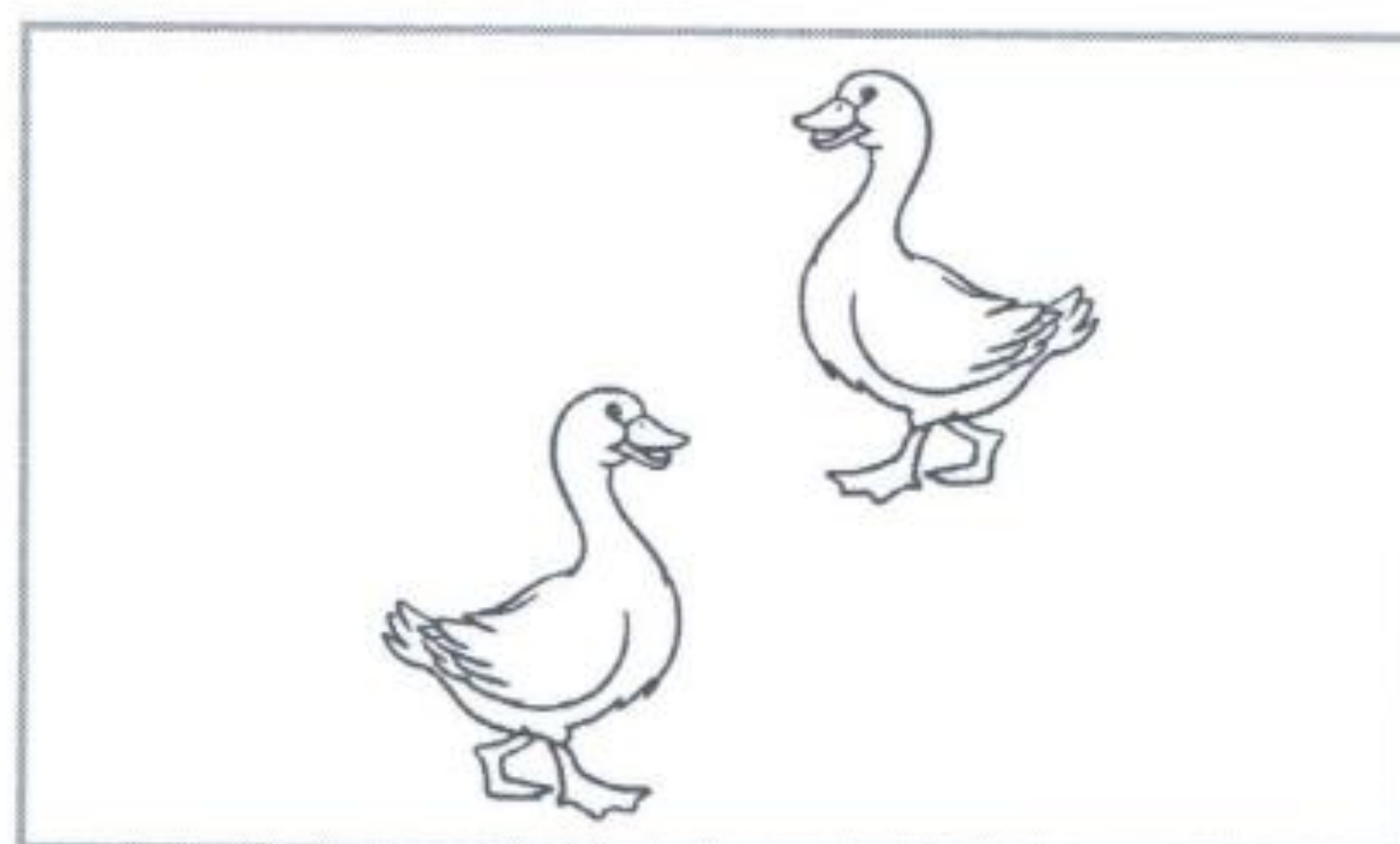

**ANATRE**

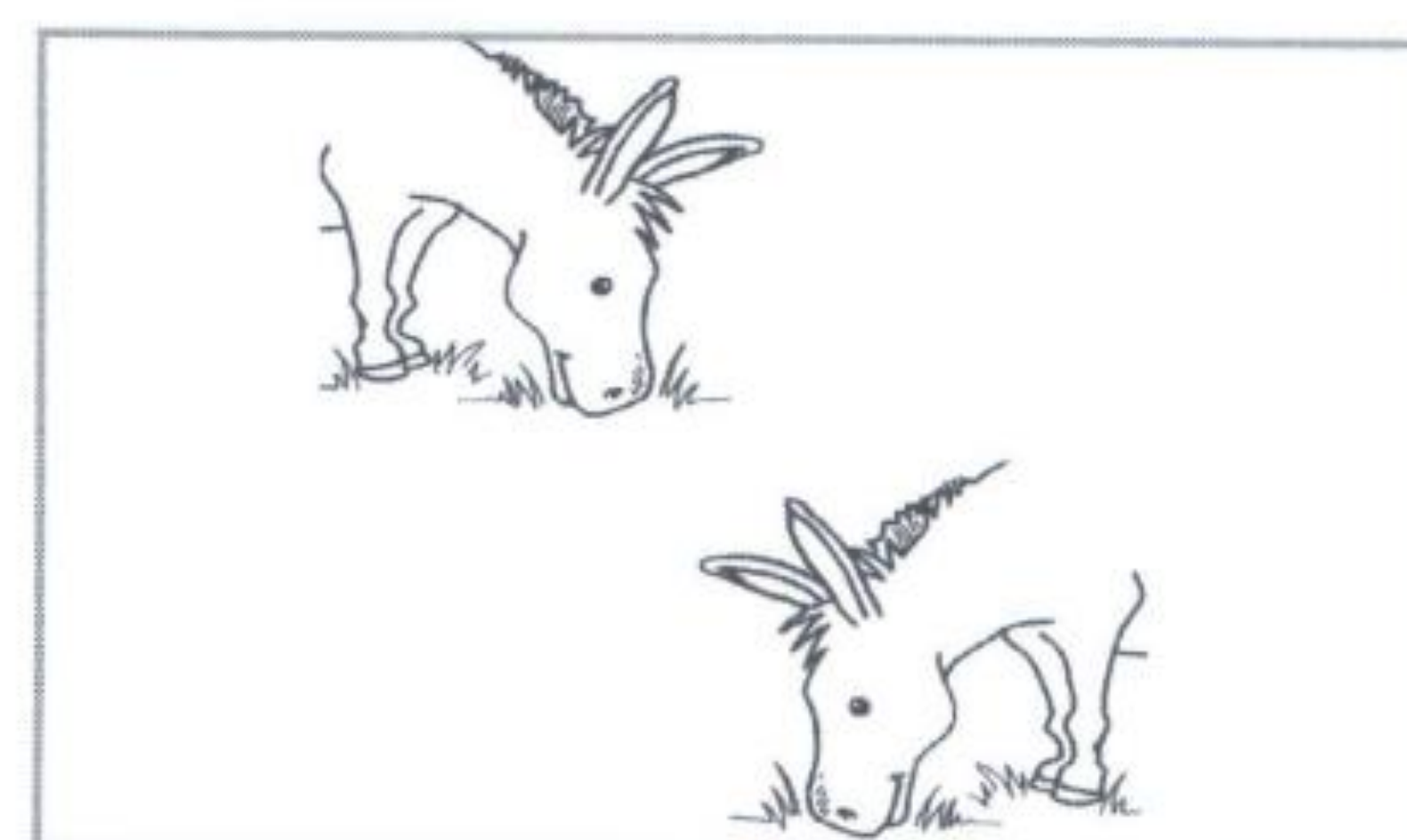

**ASINI**

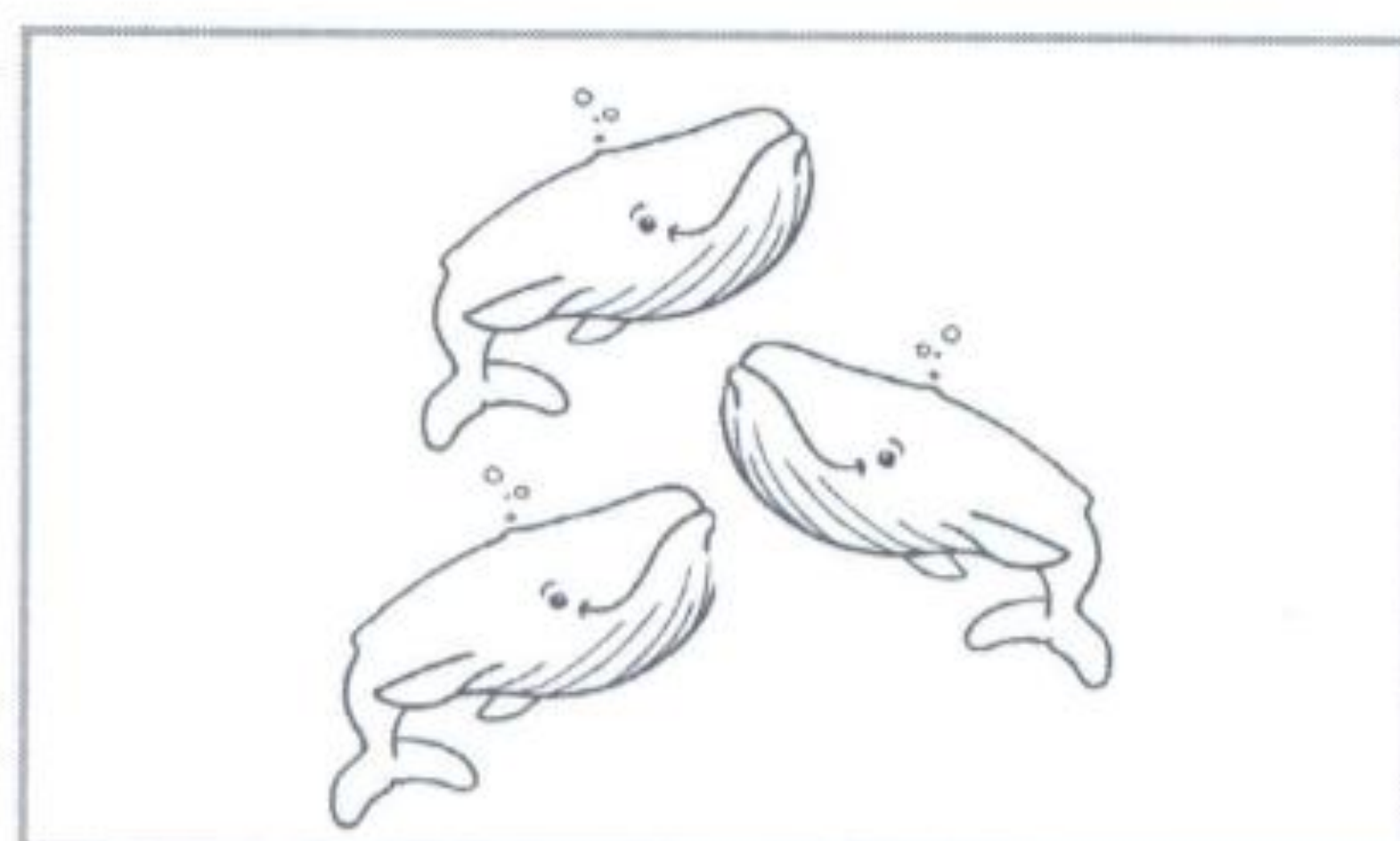

**BALENE**

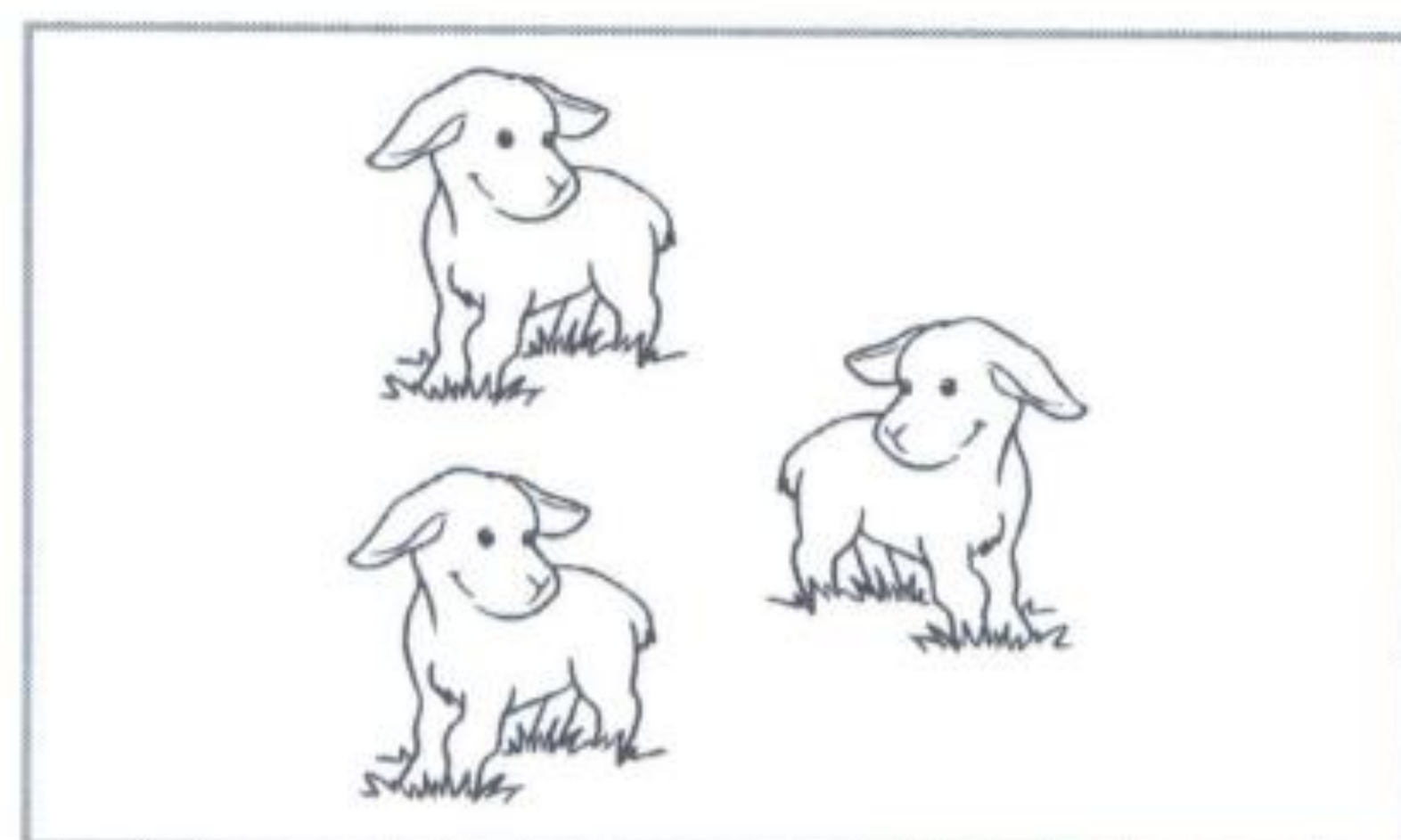

**AGNELLI**

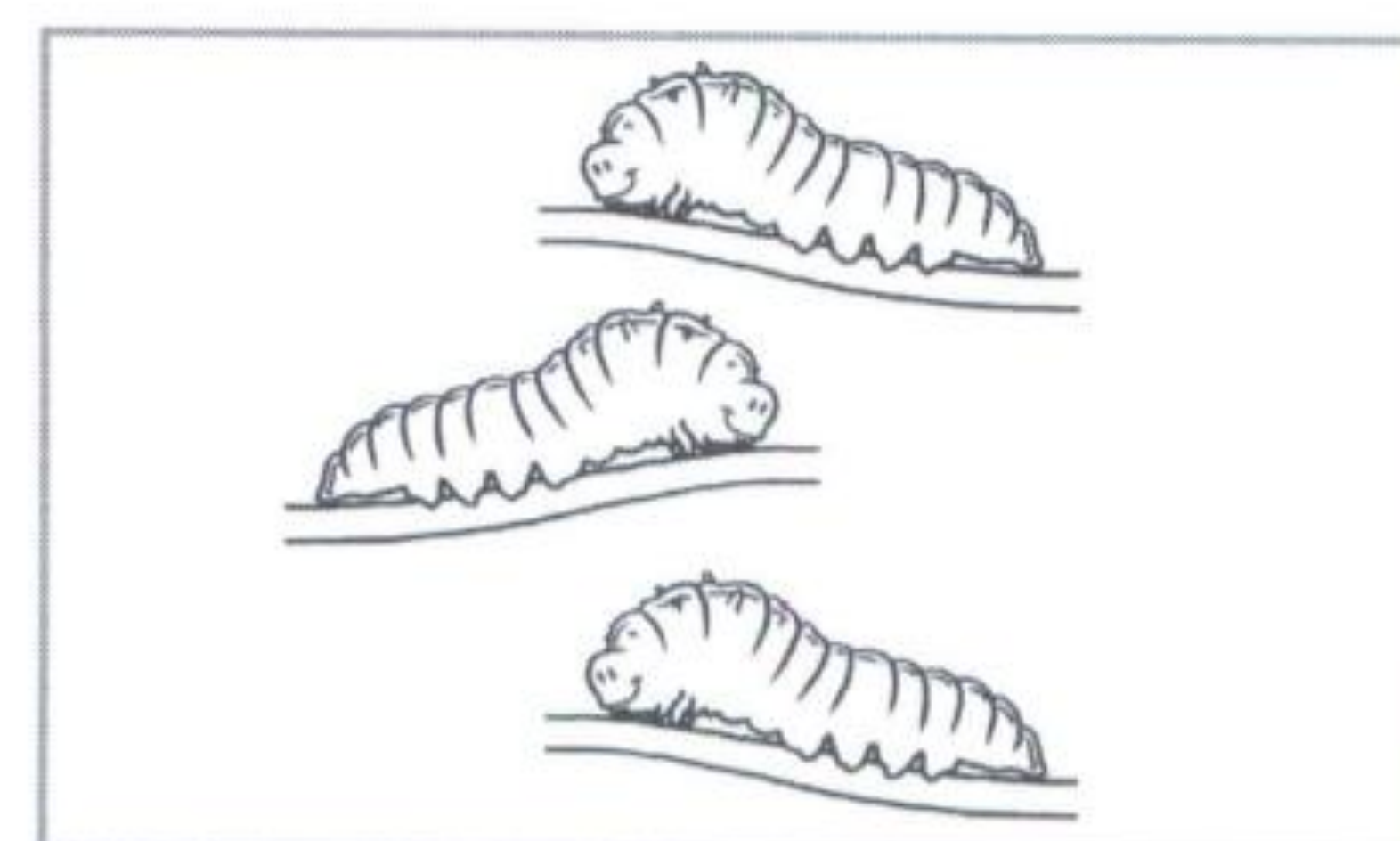

**BRUCHI**

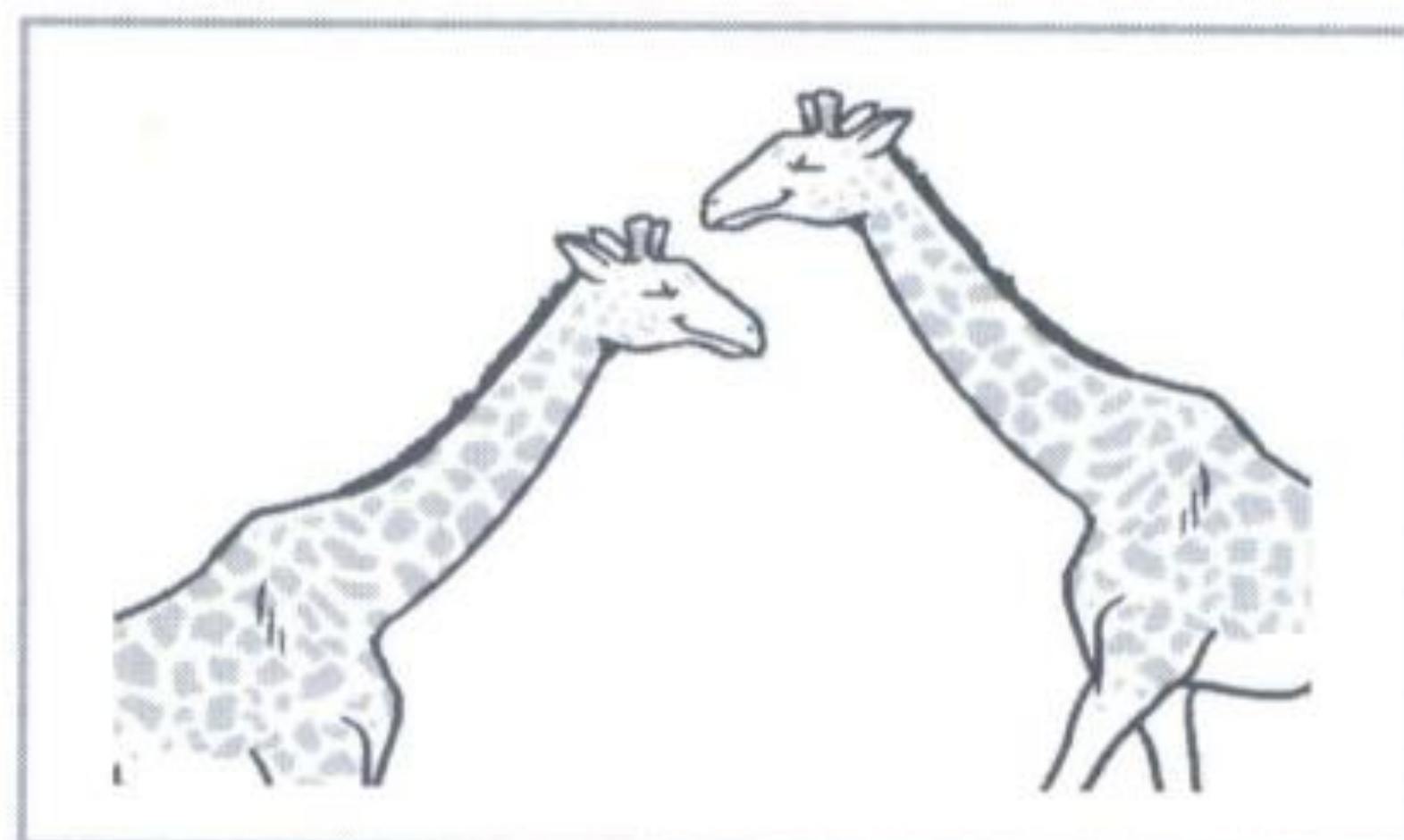

**GIRAFFE**

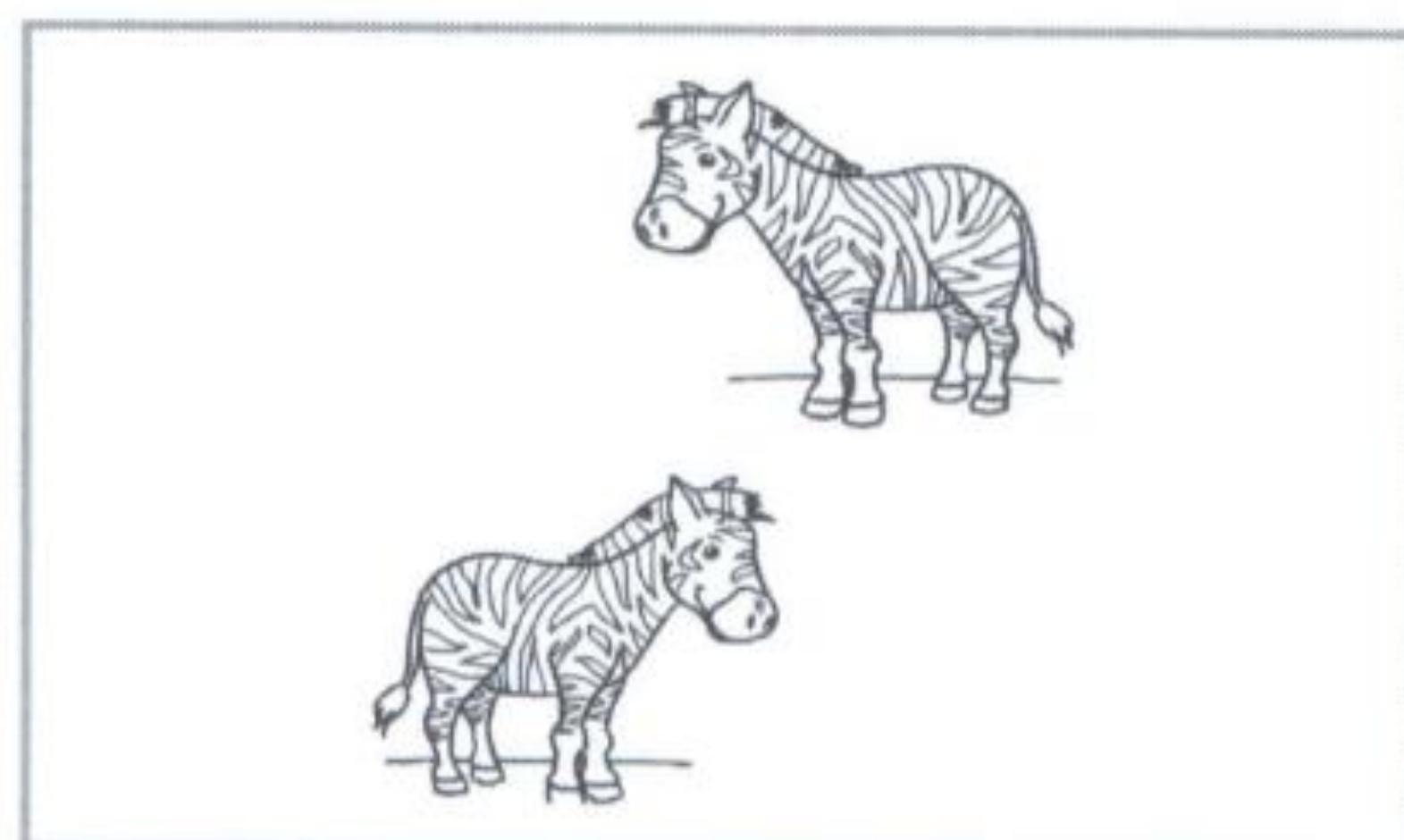

**ZEBRE**

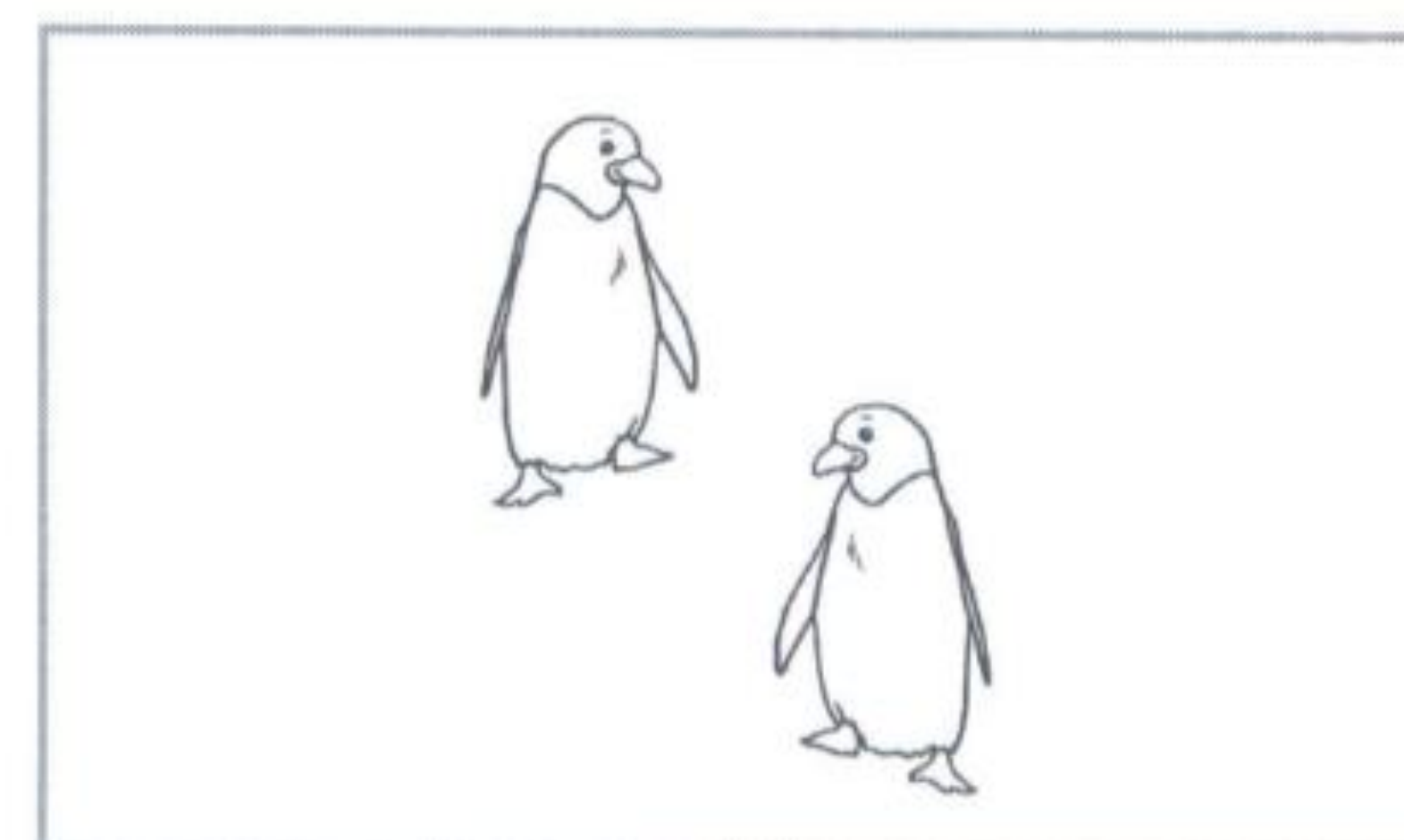

**PINGUINI**

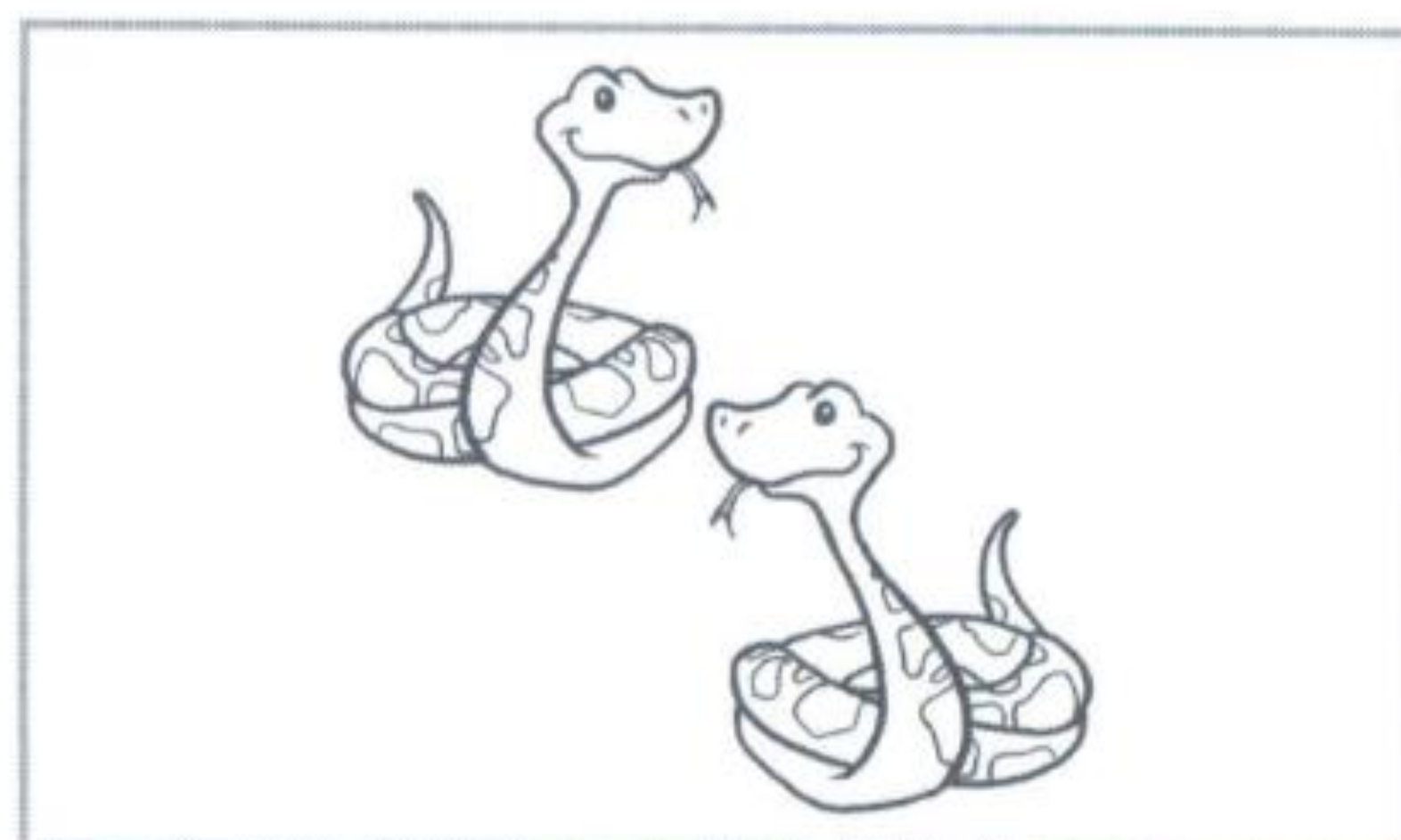

**SERPENTI**

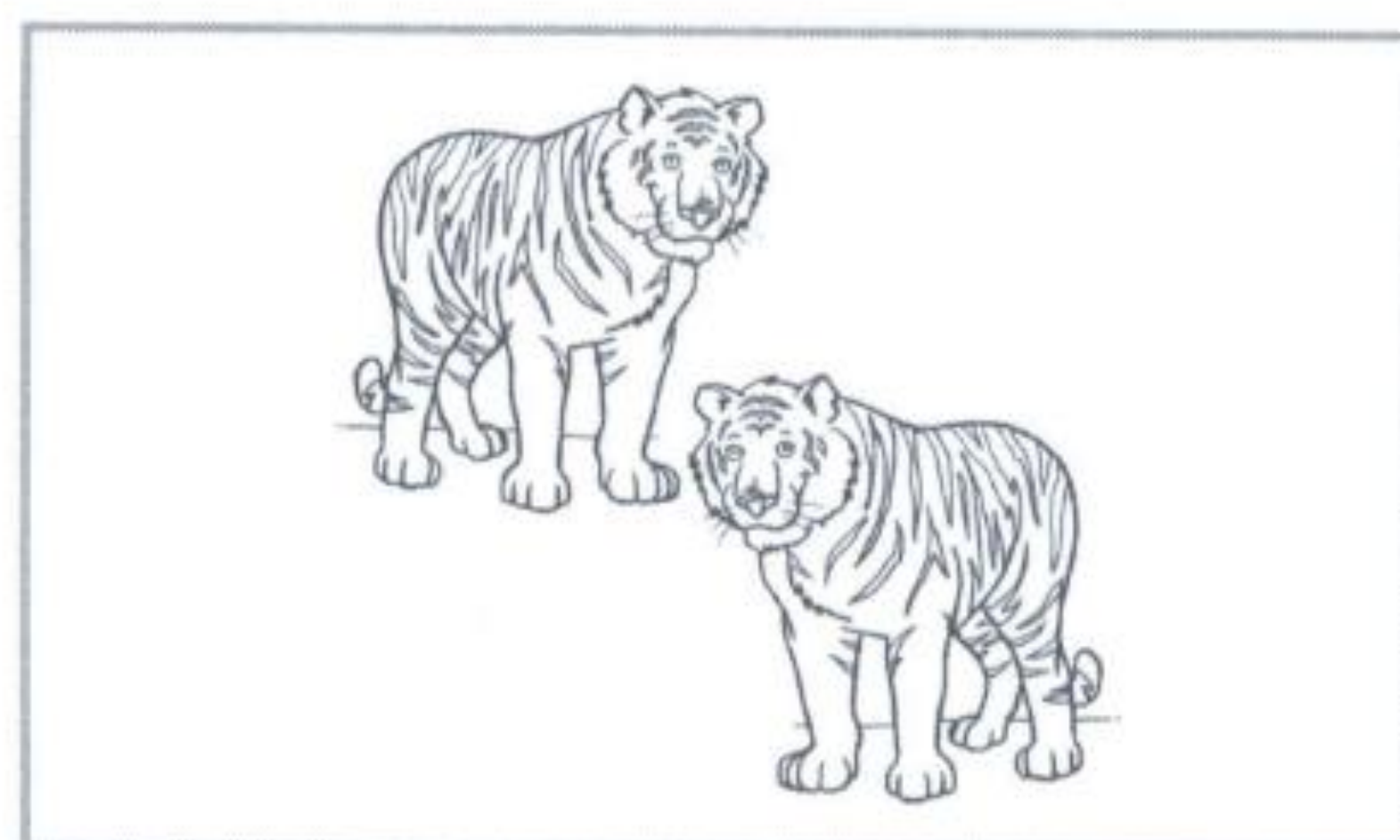

**TIGRI**

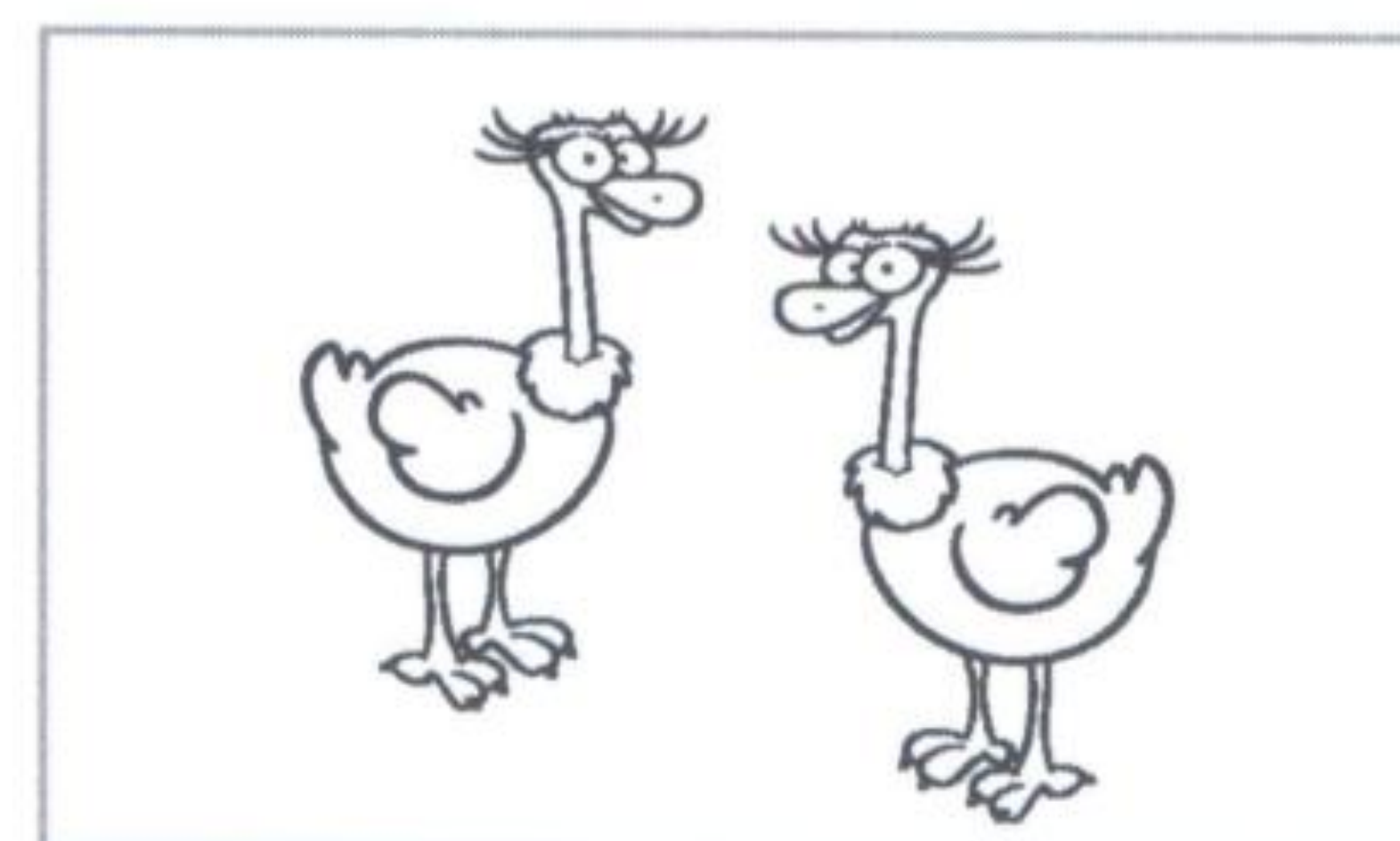

**STRUZZI**



OSSERVA, LEGGI E RIPASSA L'ARTICOLO  
INDETERMINATIVO GIUSTO

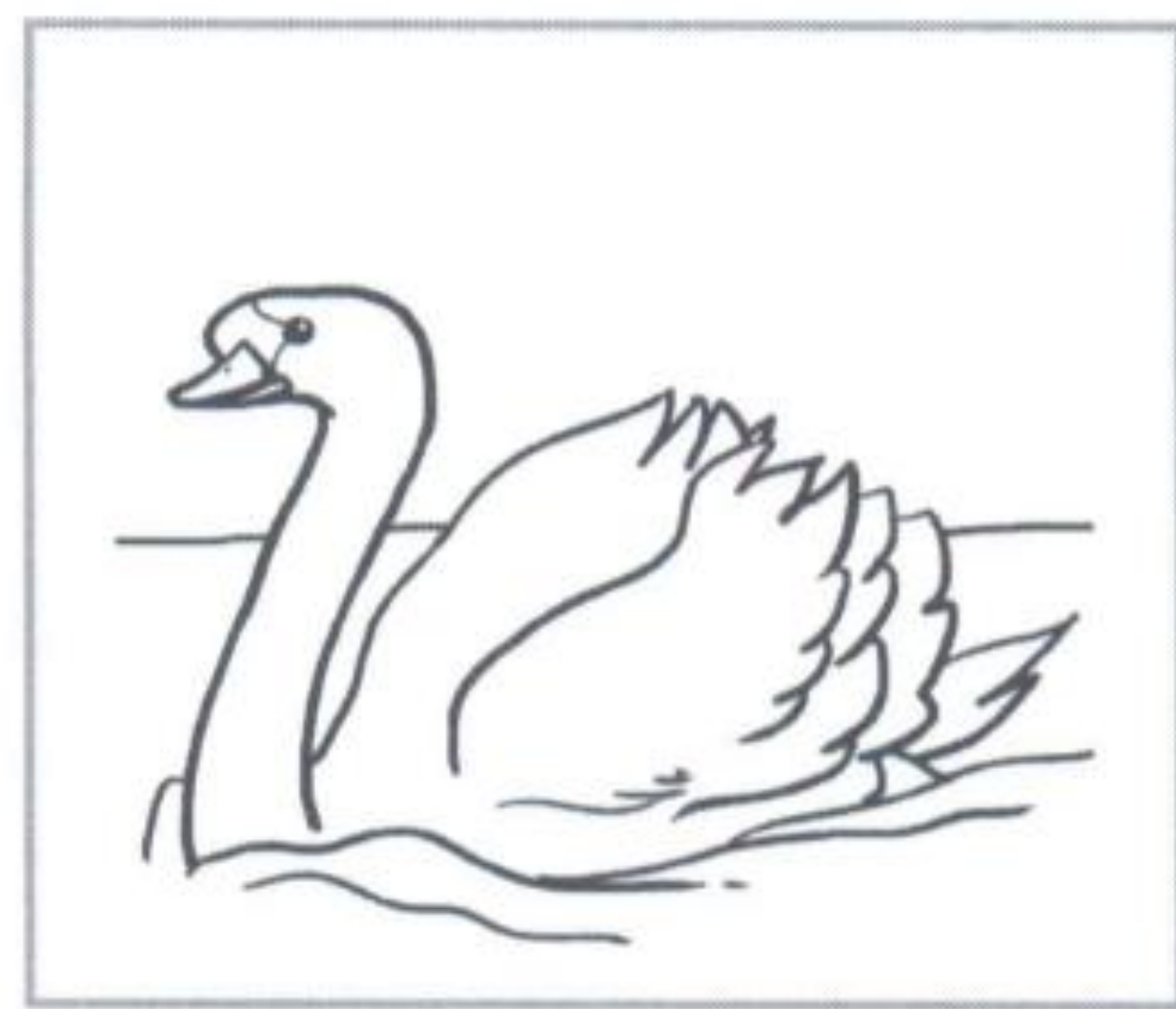

UN

CIGNO

UNO

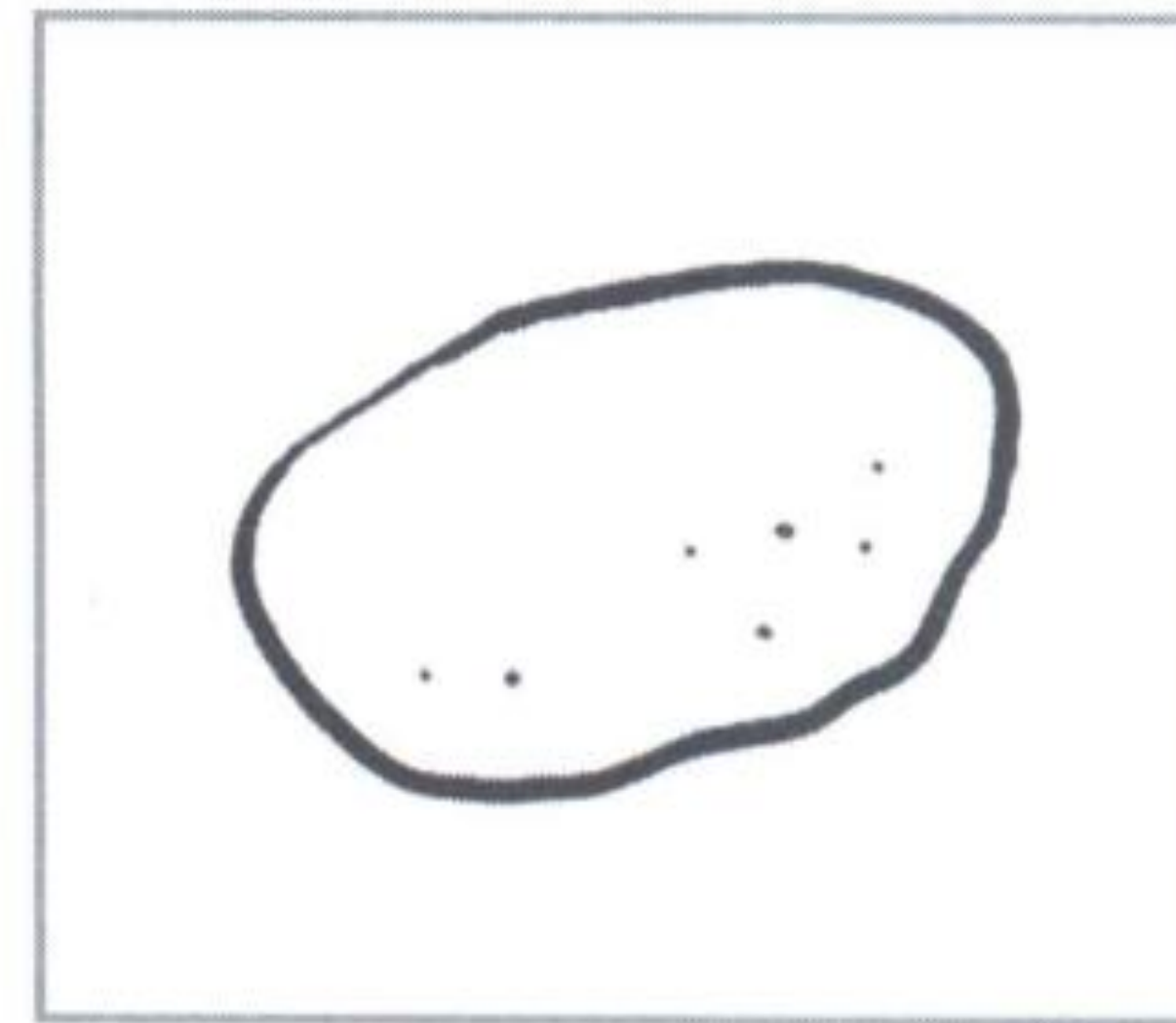

UNA

PATATA

UN'

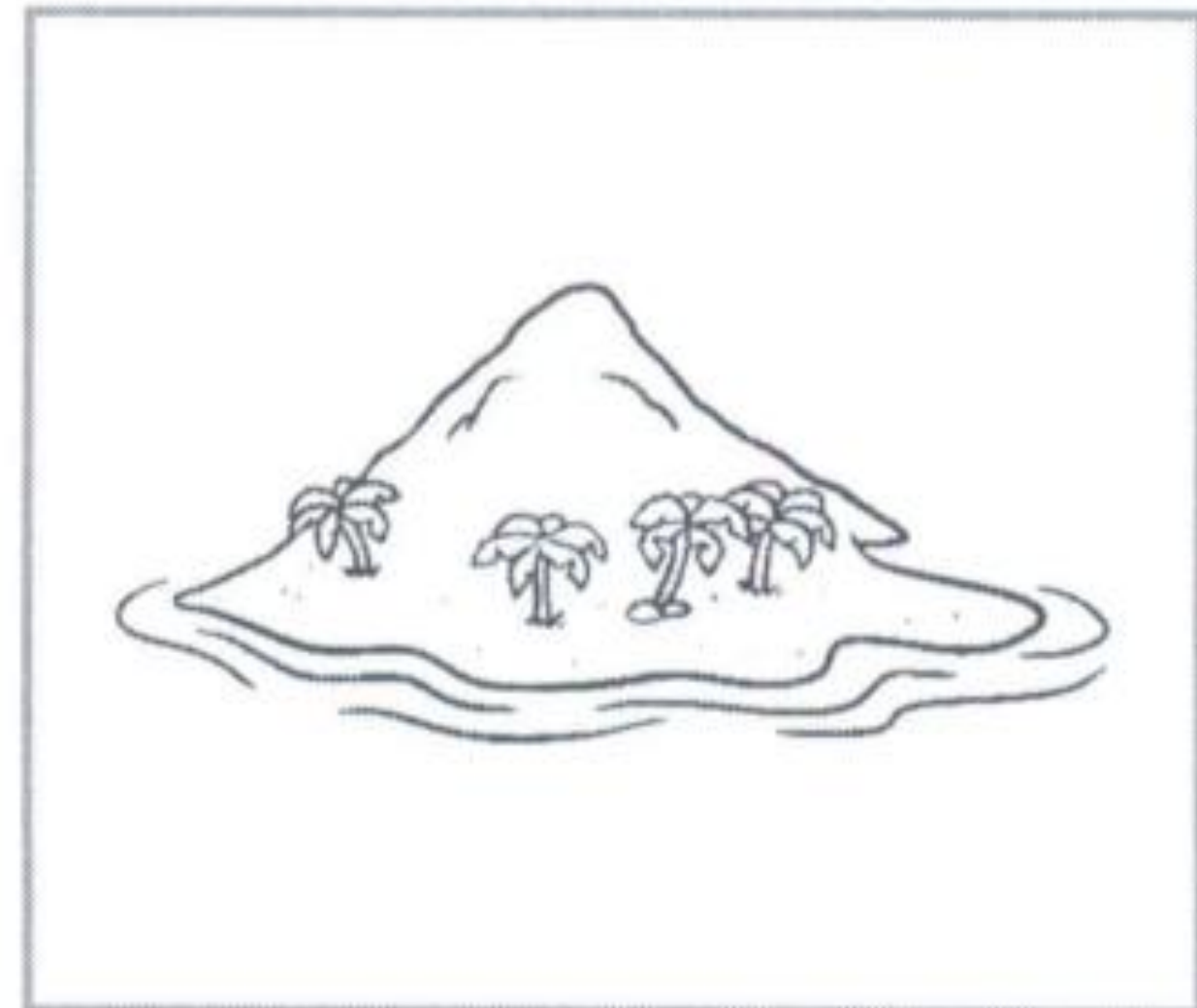

UN'

ISOLA

UN



UN

STIVALE

UNO

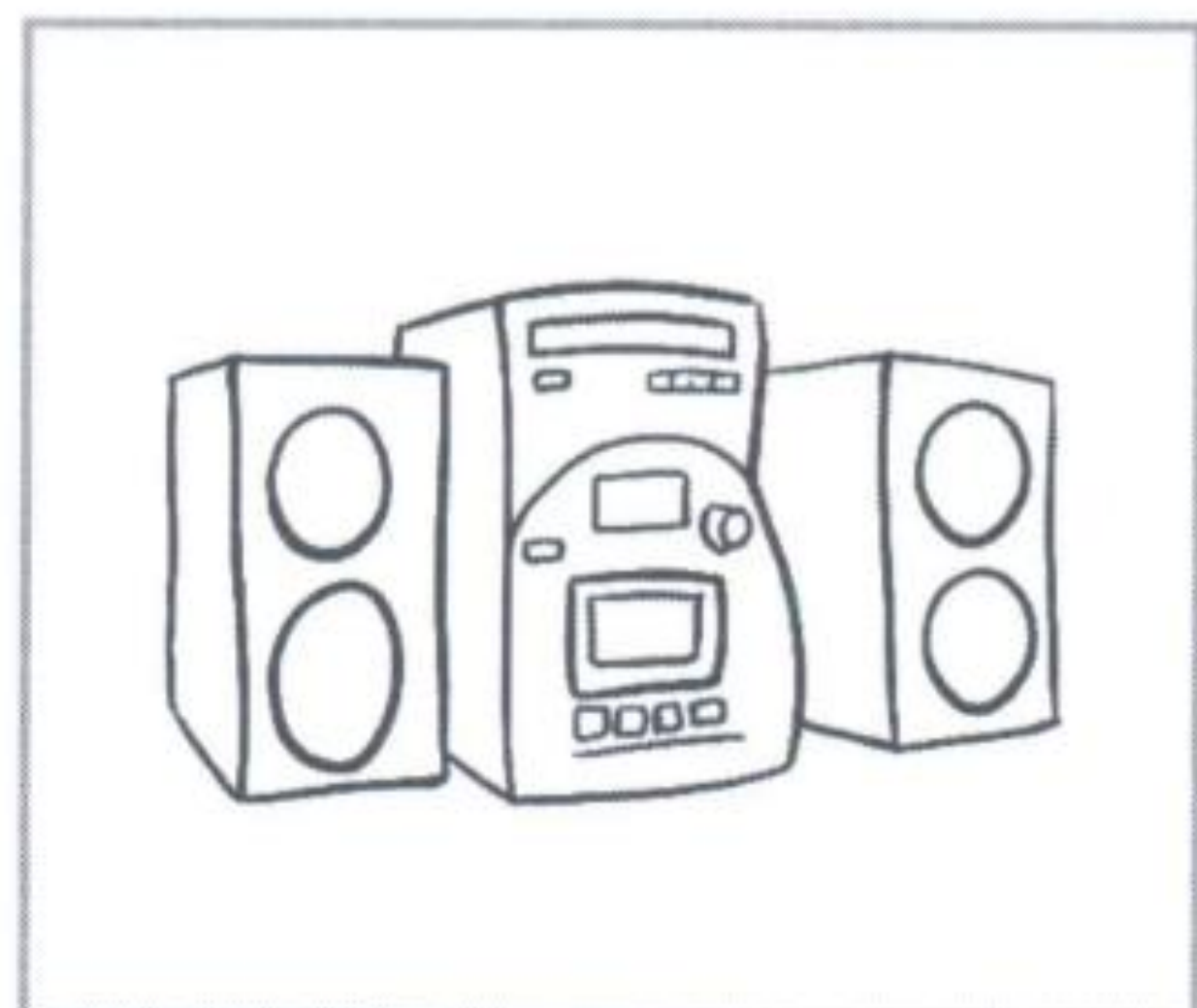

UNO

STEREO

UN



UNA

AQUILA

UN'

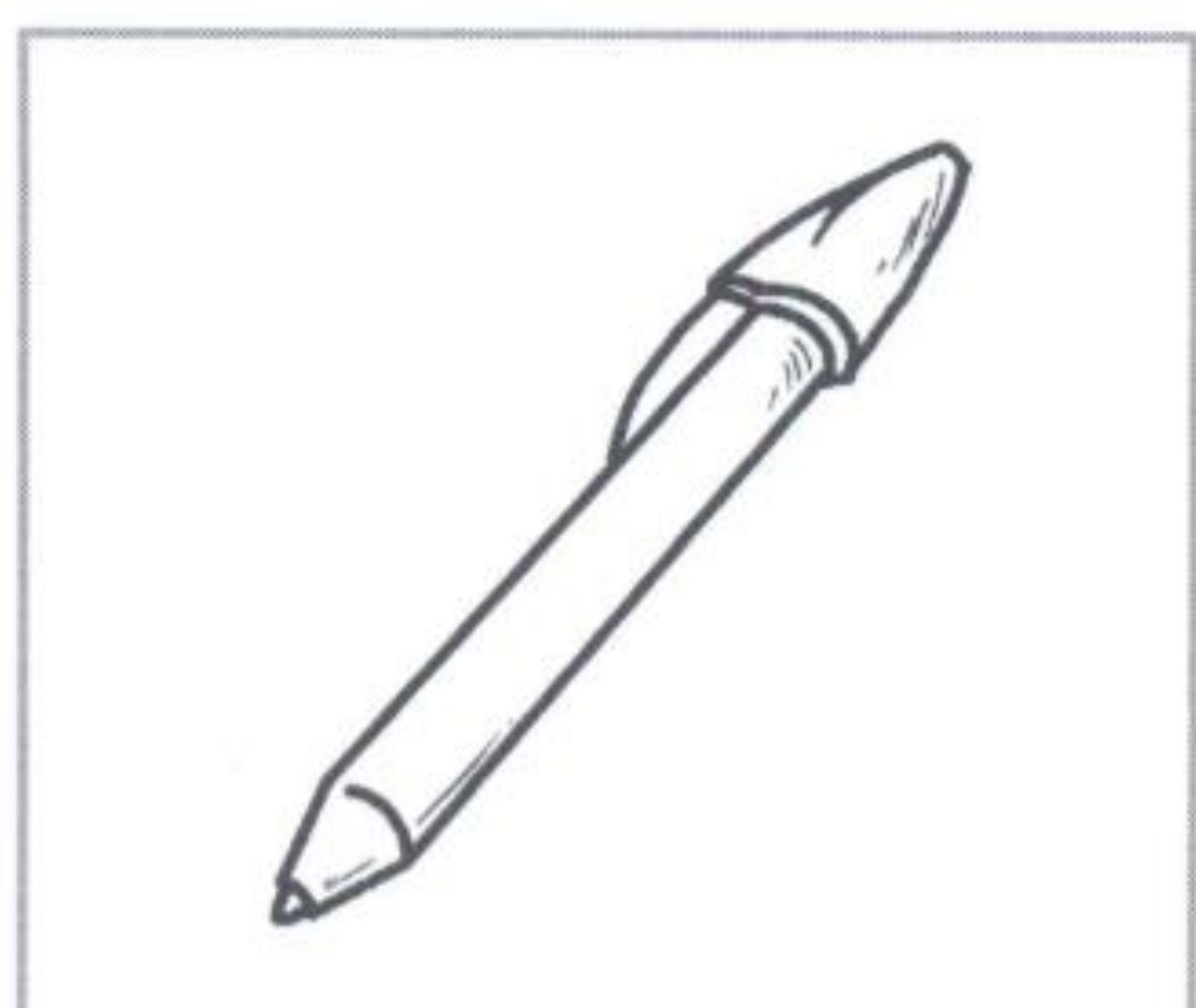

UN

PENNA

UNA



UN

ALA

UN'



UN'

MULINO

UN



UN

ANGELO

UN'



UN

GNOMO

UNO



UNA

SCOPA

UNO

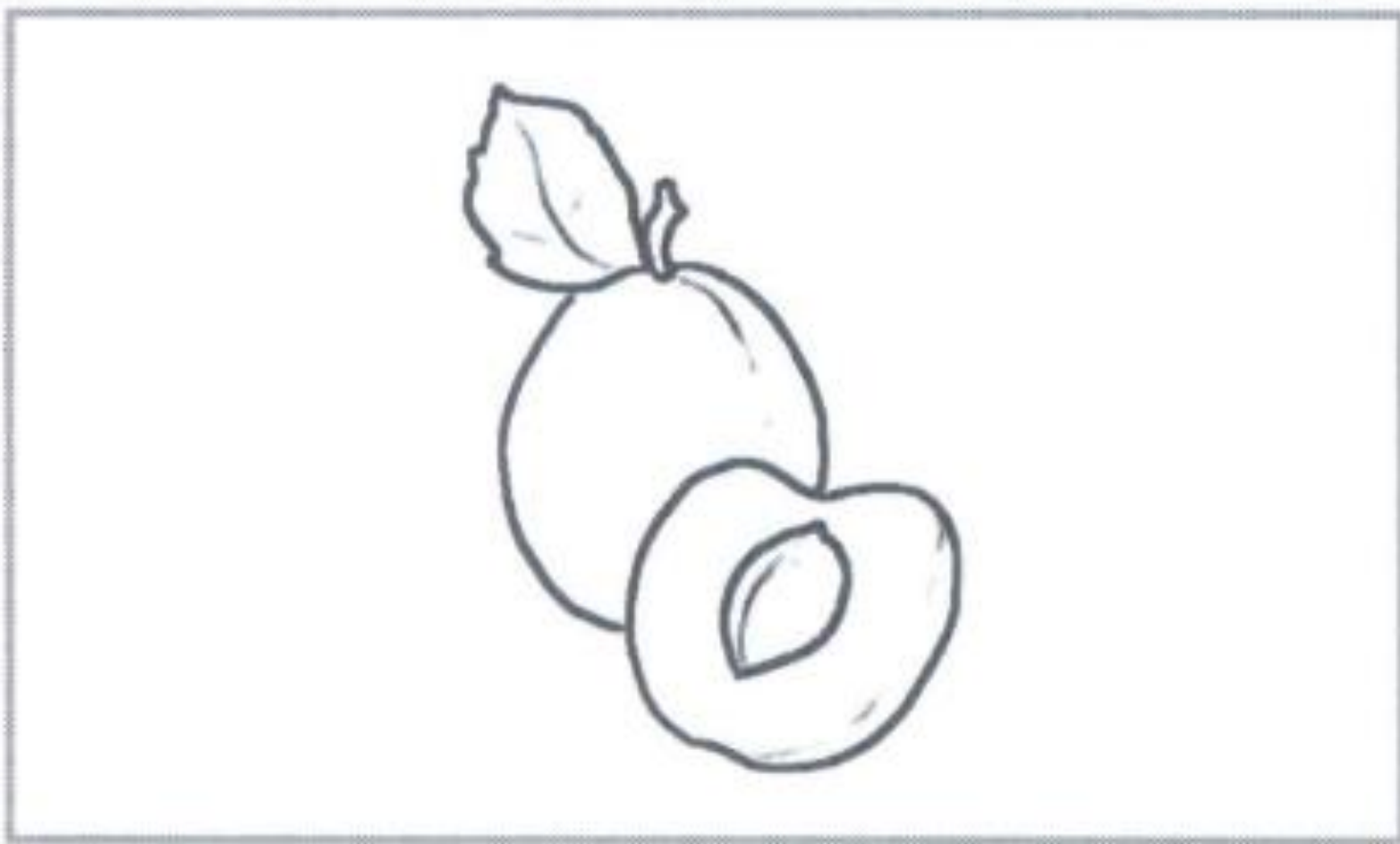

**ALBICOCCA**



**FINESTRA**



**SCIROPPO**

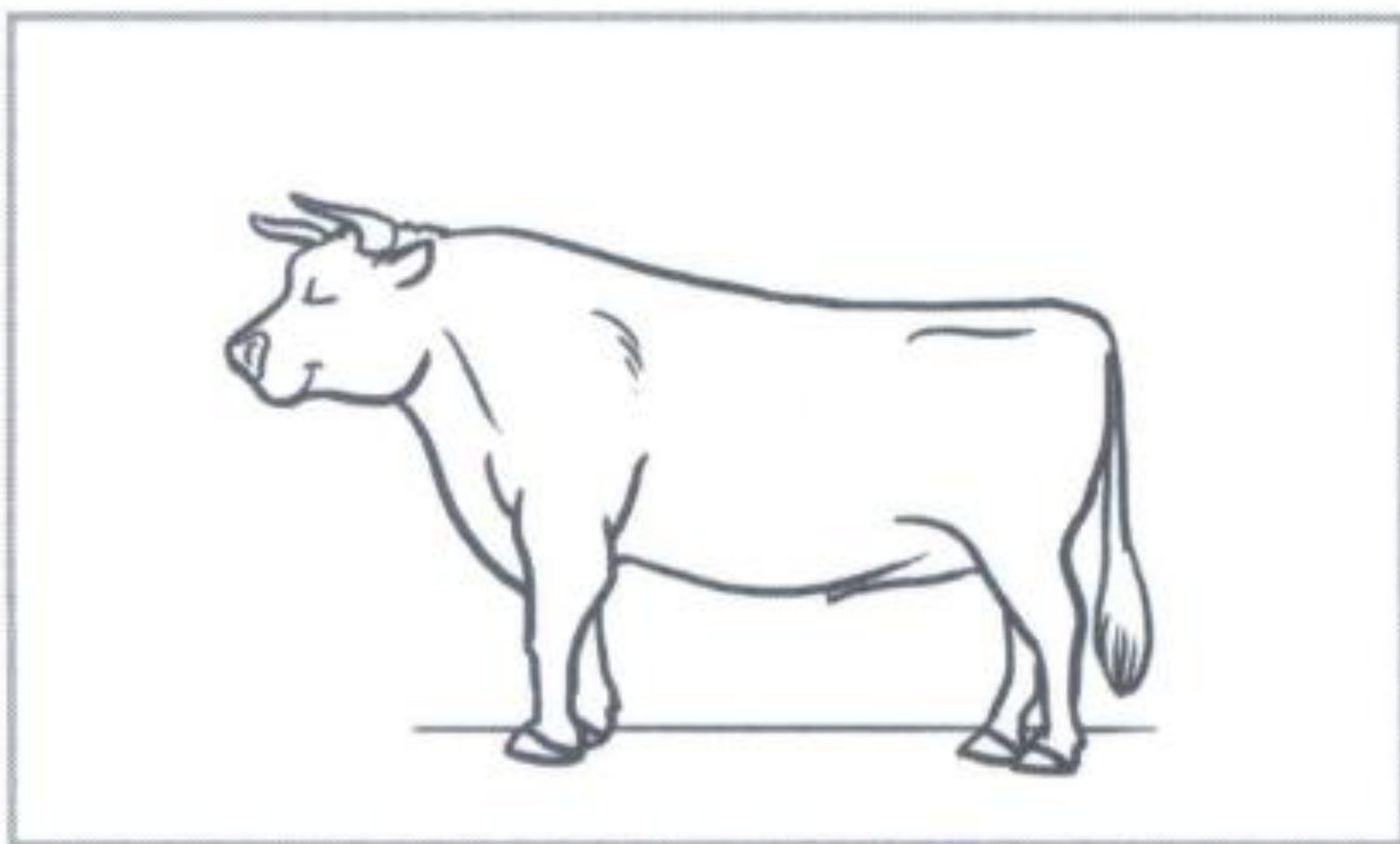

**TORO**

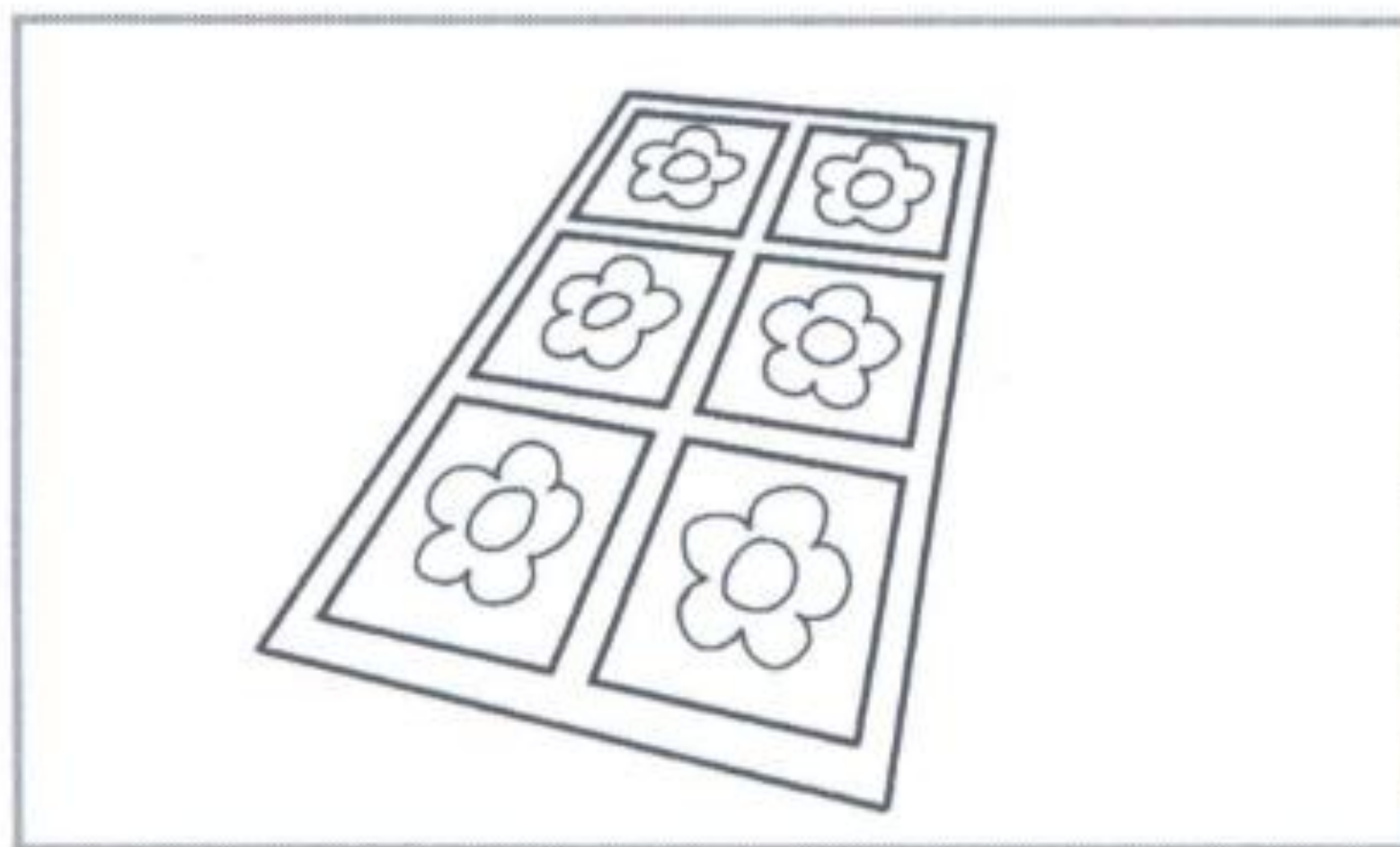

**TAPPETO**

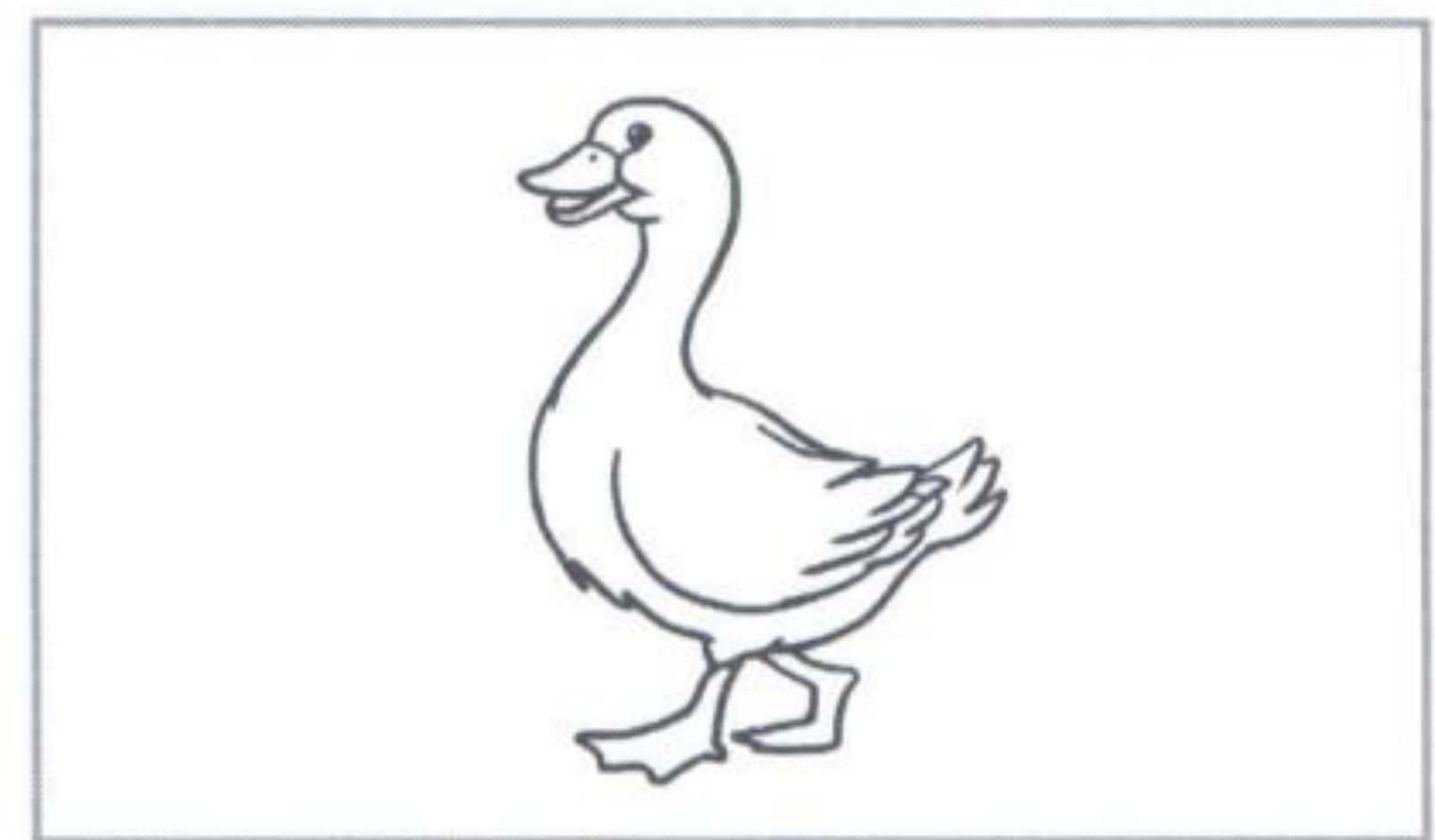

**ANATRA**



**INDIANA**



**FORCHETTA**

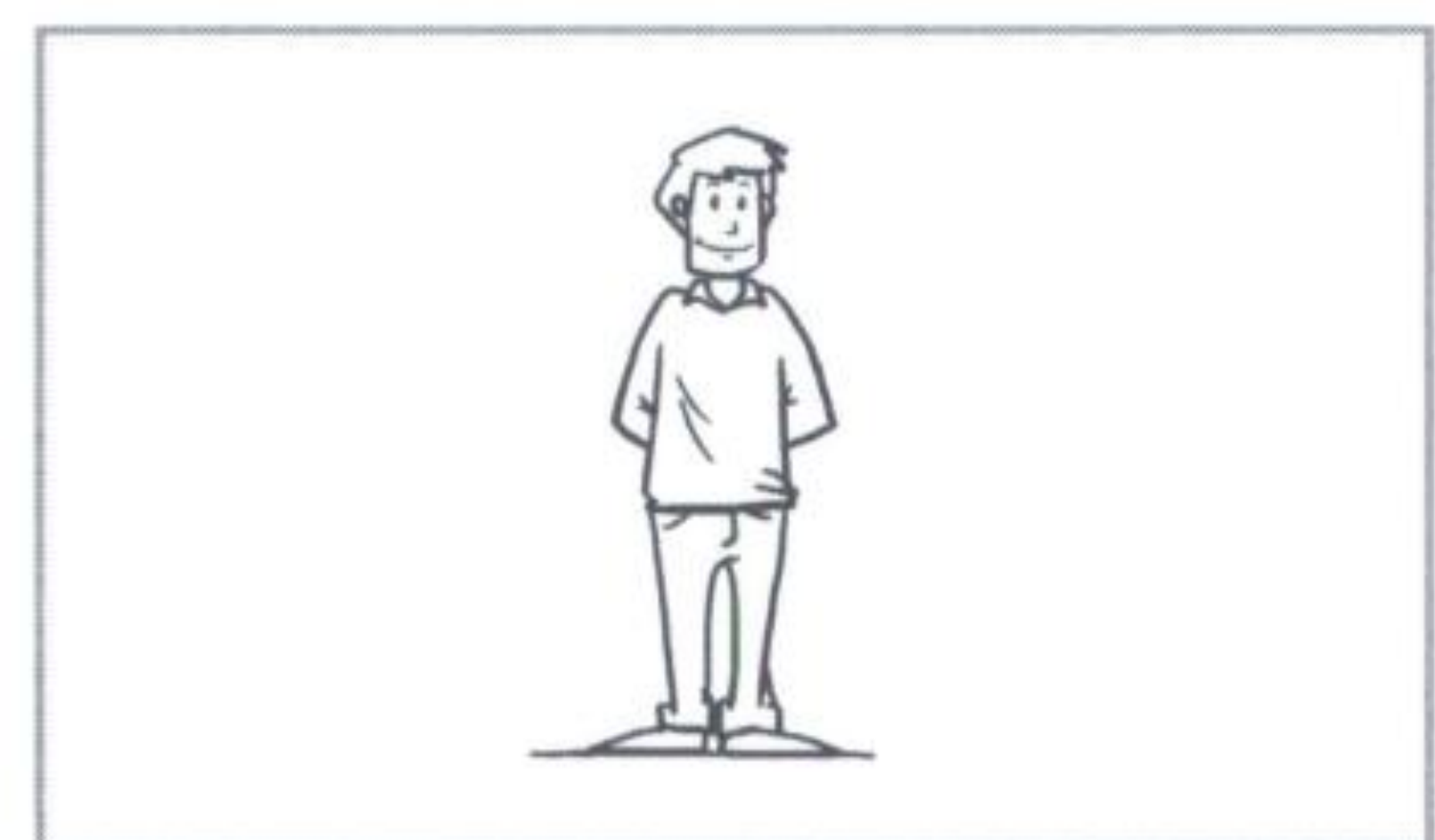

**UOMO**

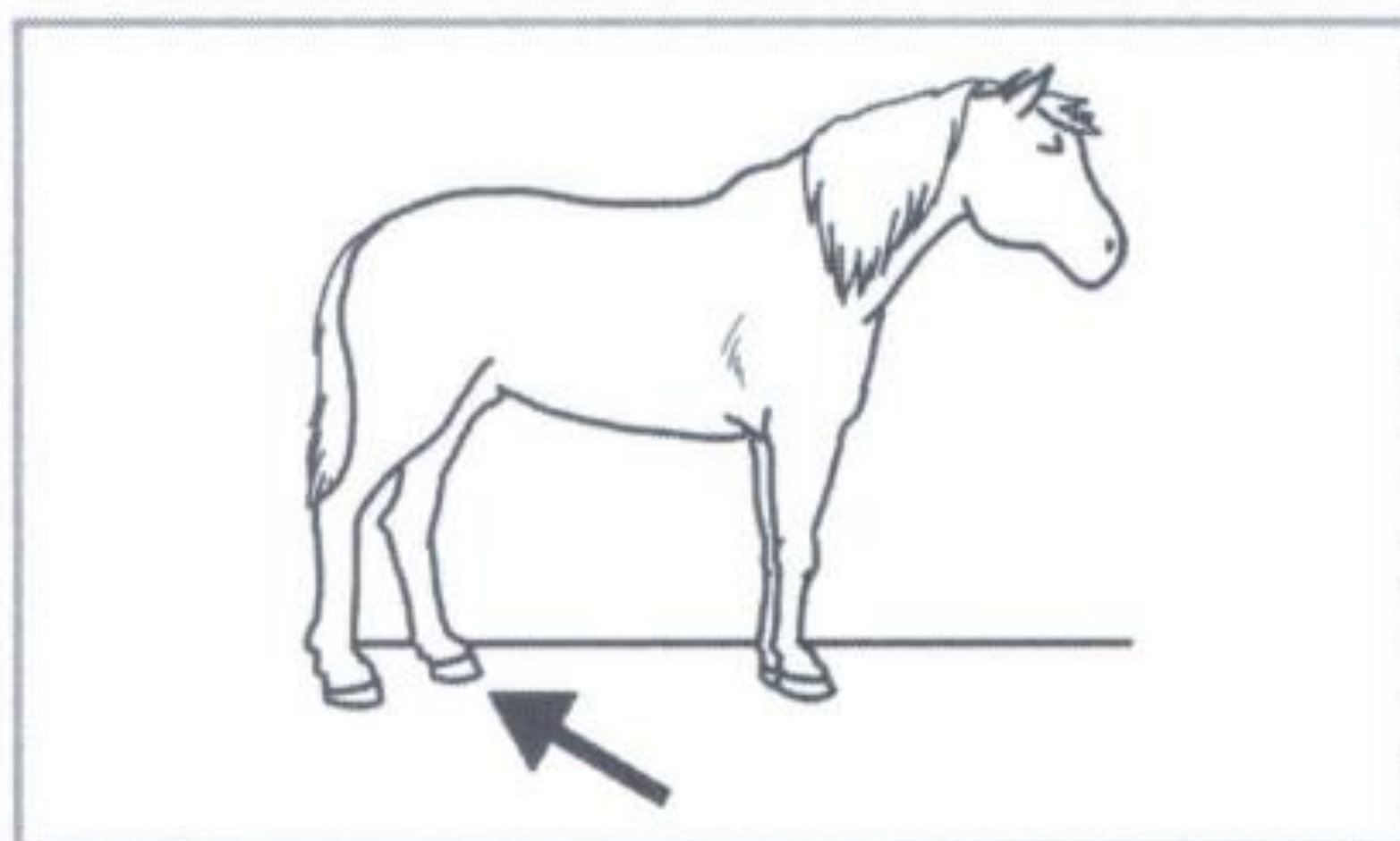

**ZOCCOLO**

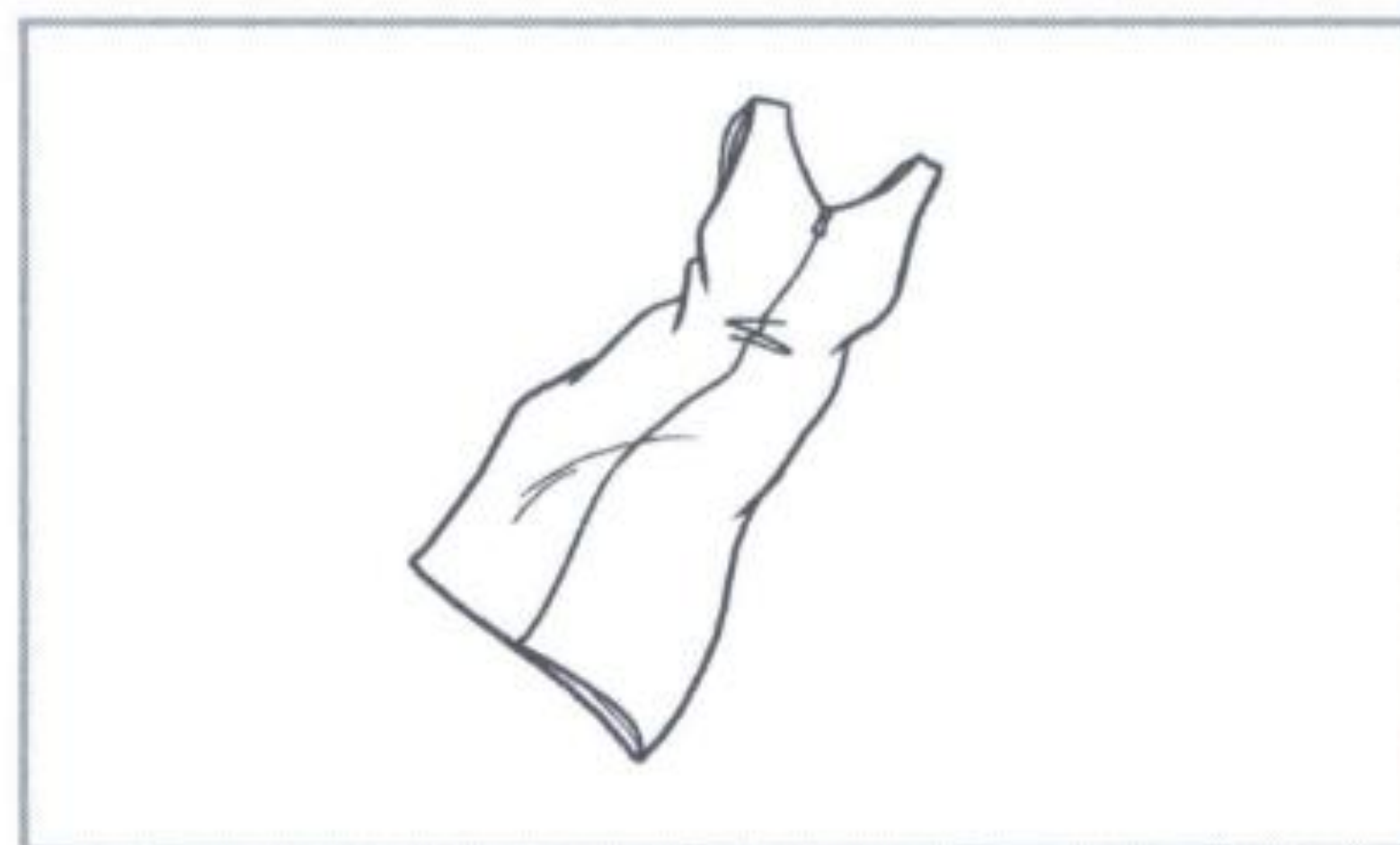

**VESTITO**

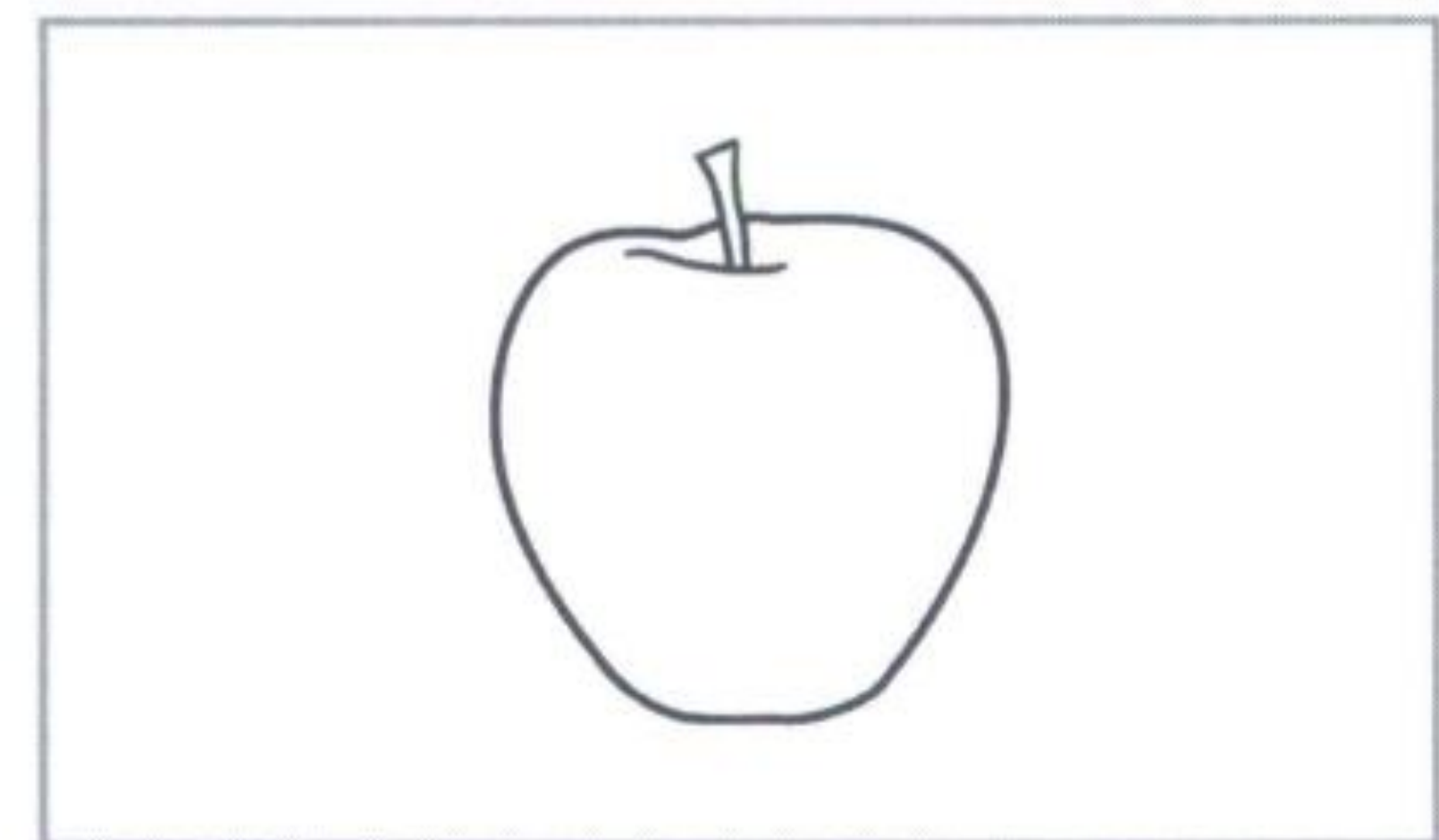

**MELA**

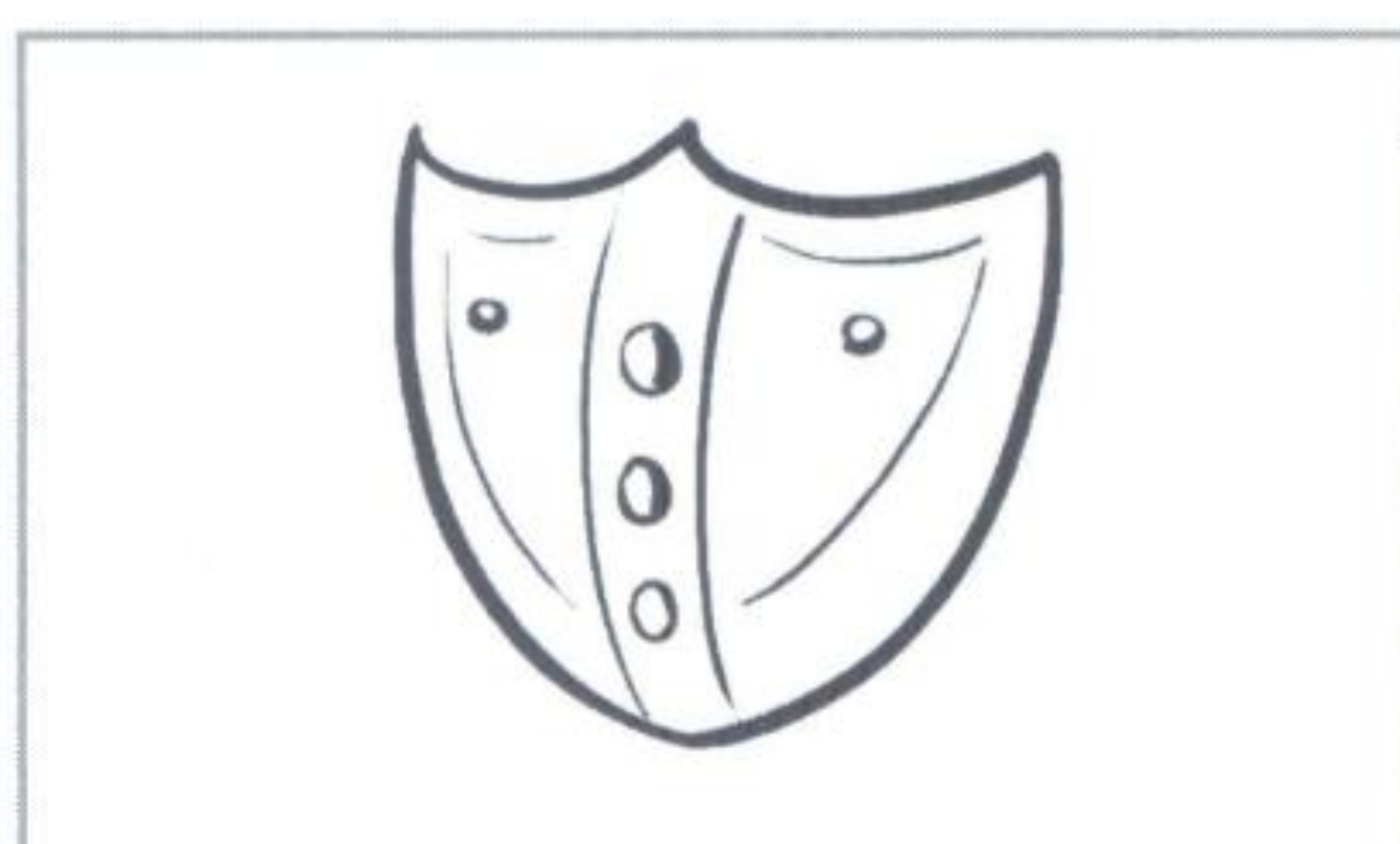

**SCUDO**

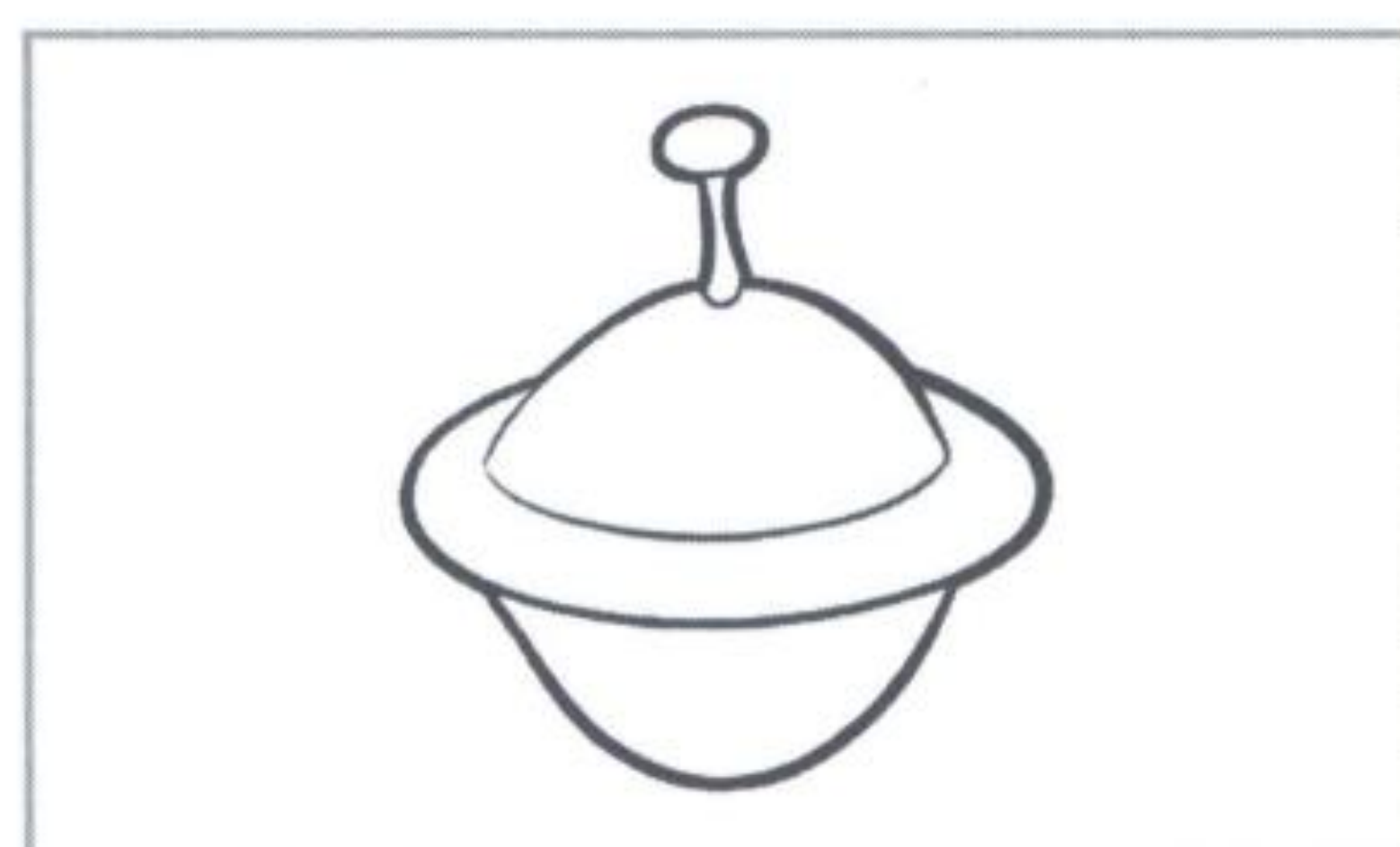

**TROTTOLA**

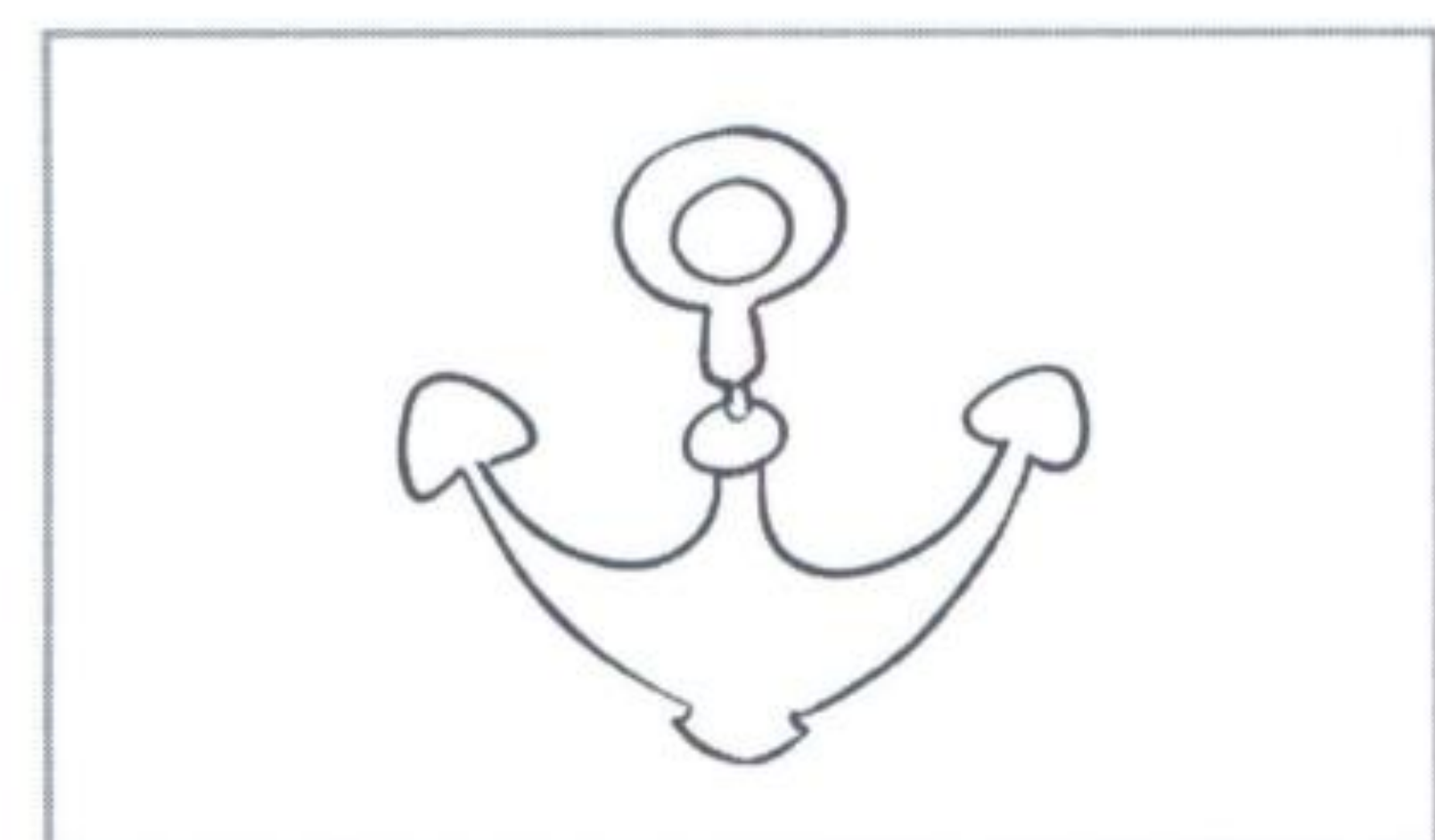

**ANCORA**



OSSERVA I DISEGNI E COMPLETA LE FRASI IN STAMPATO MAIUSCOLO

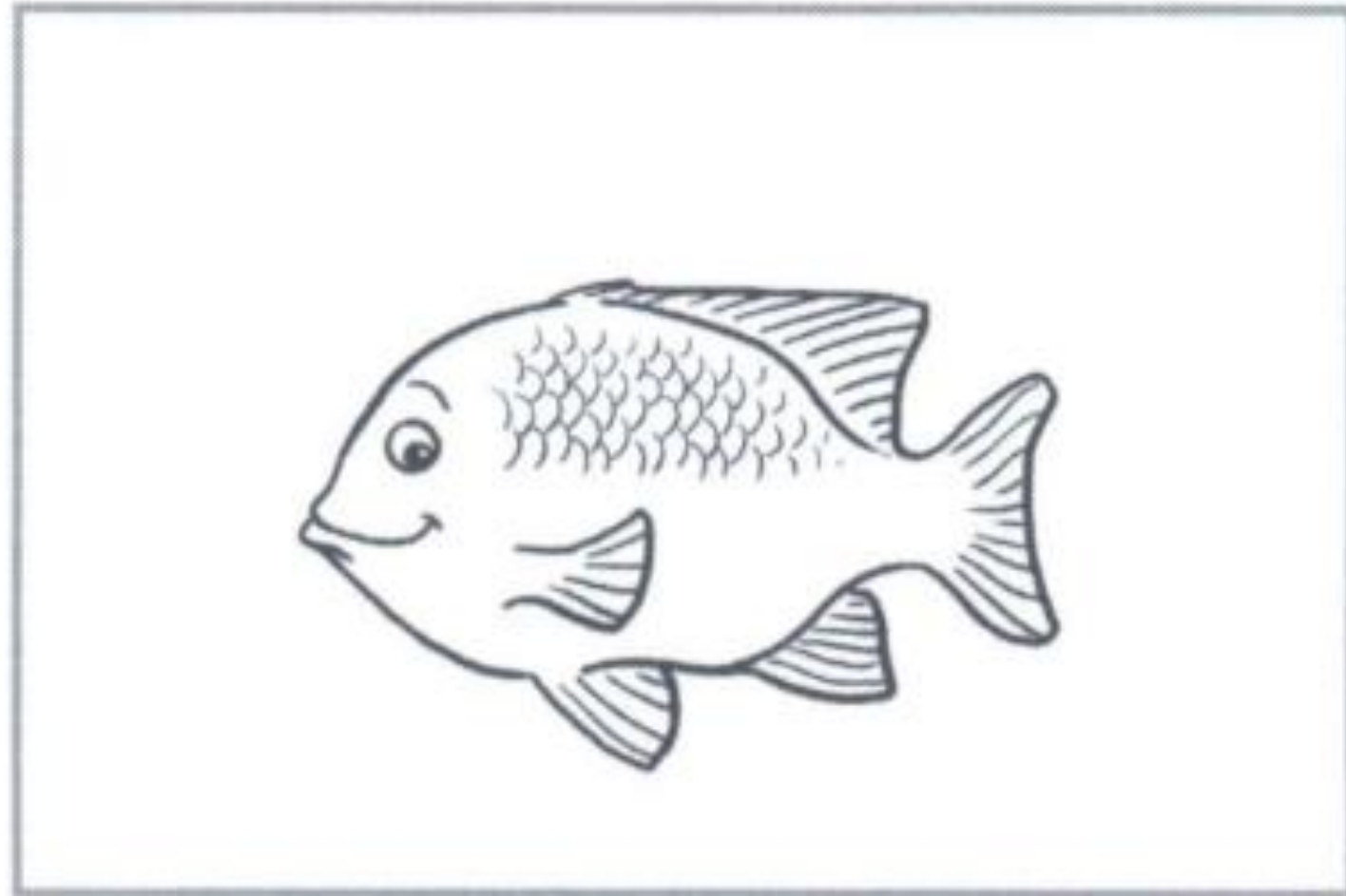

IL

NUOTA NEL

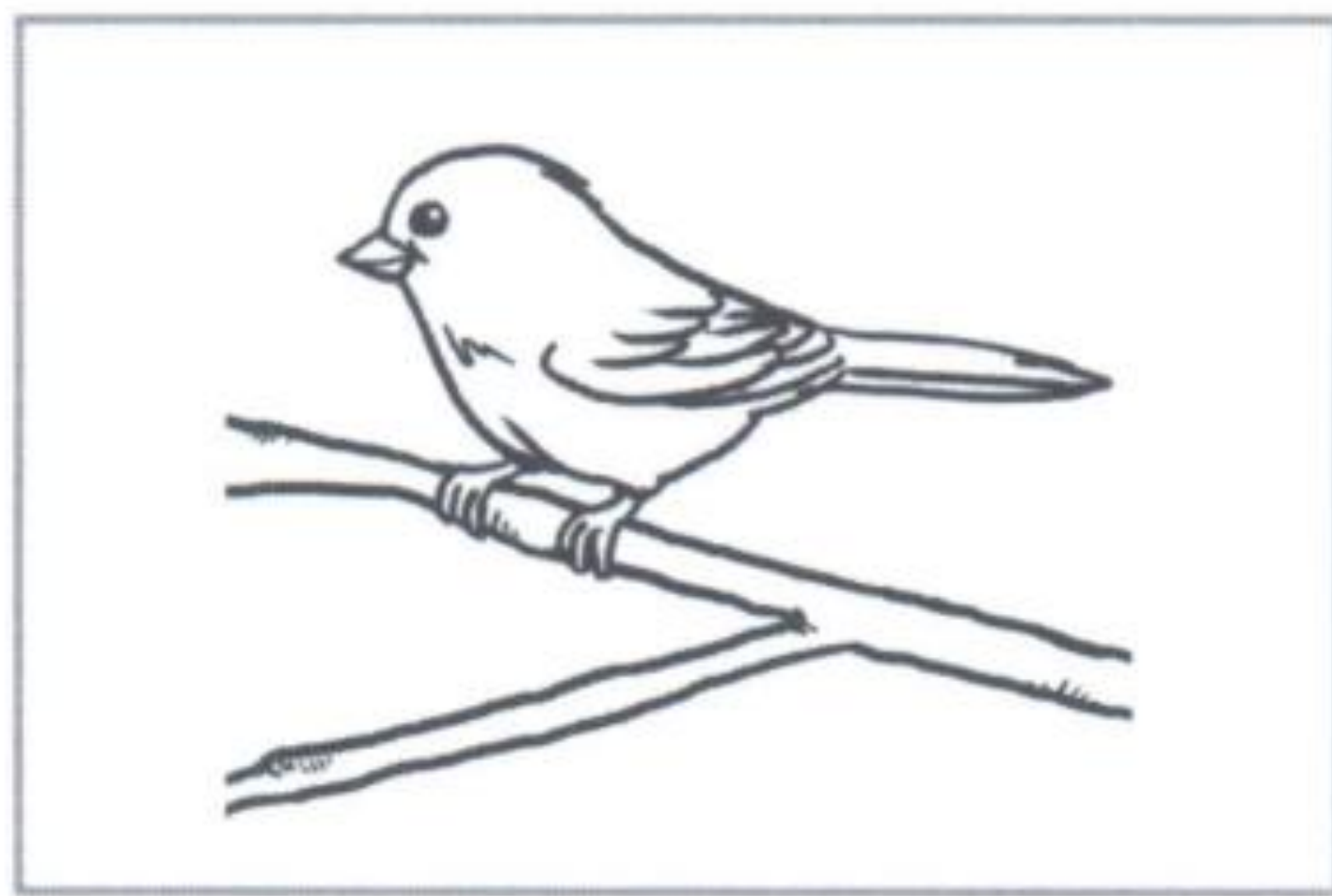
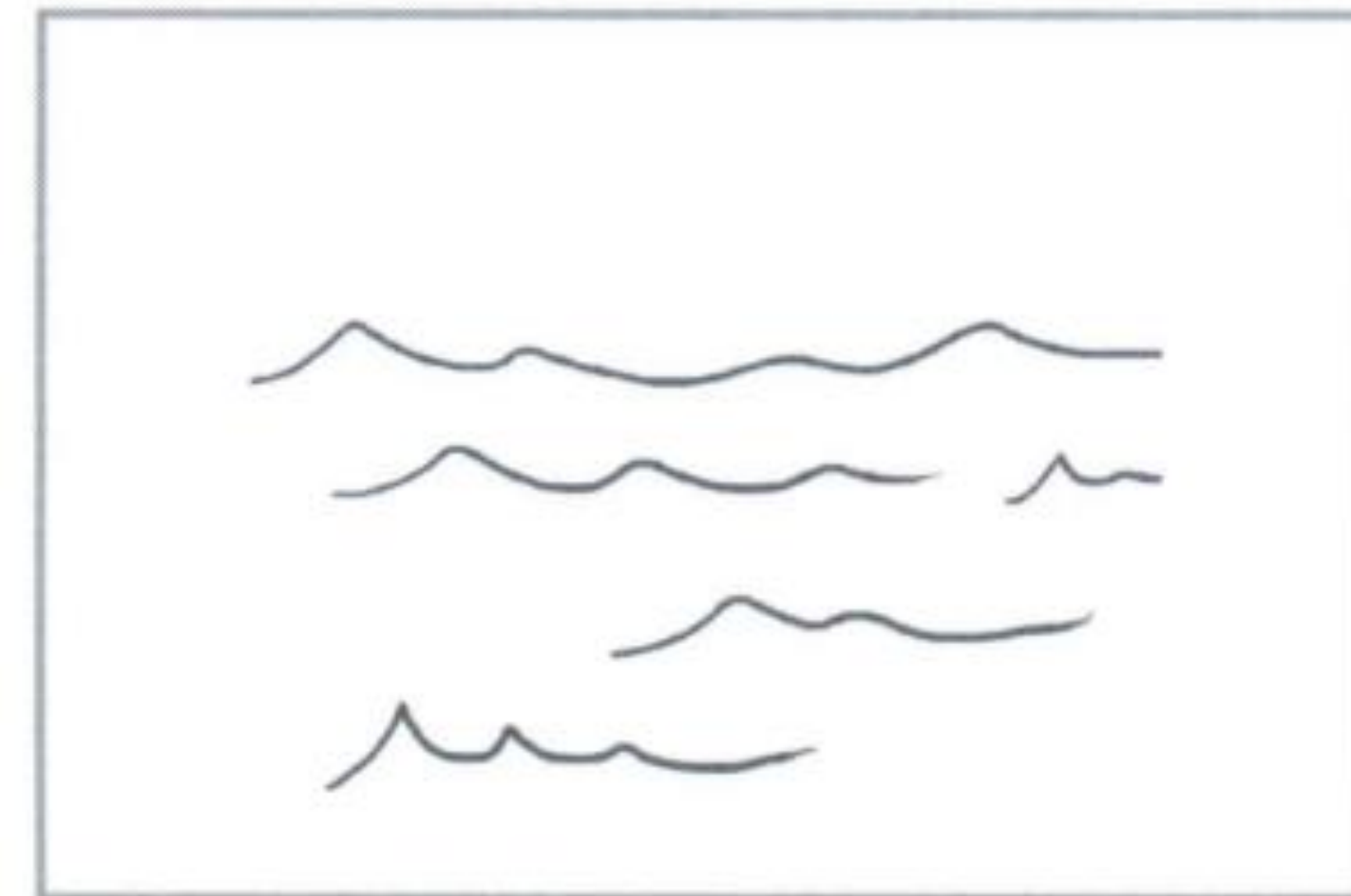

L'

VOLA SULL'

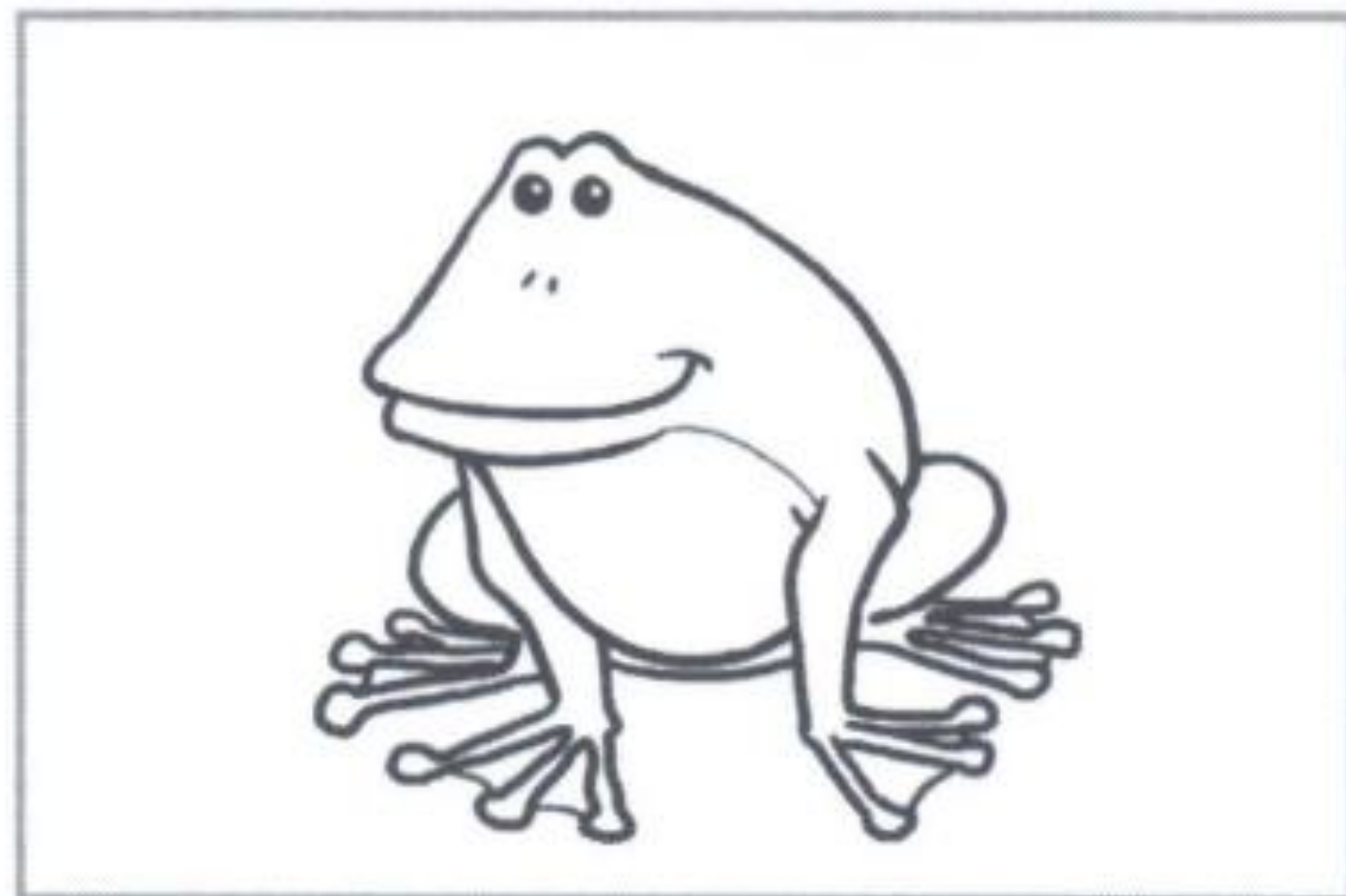
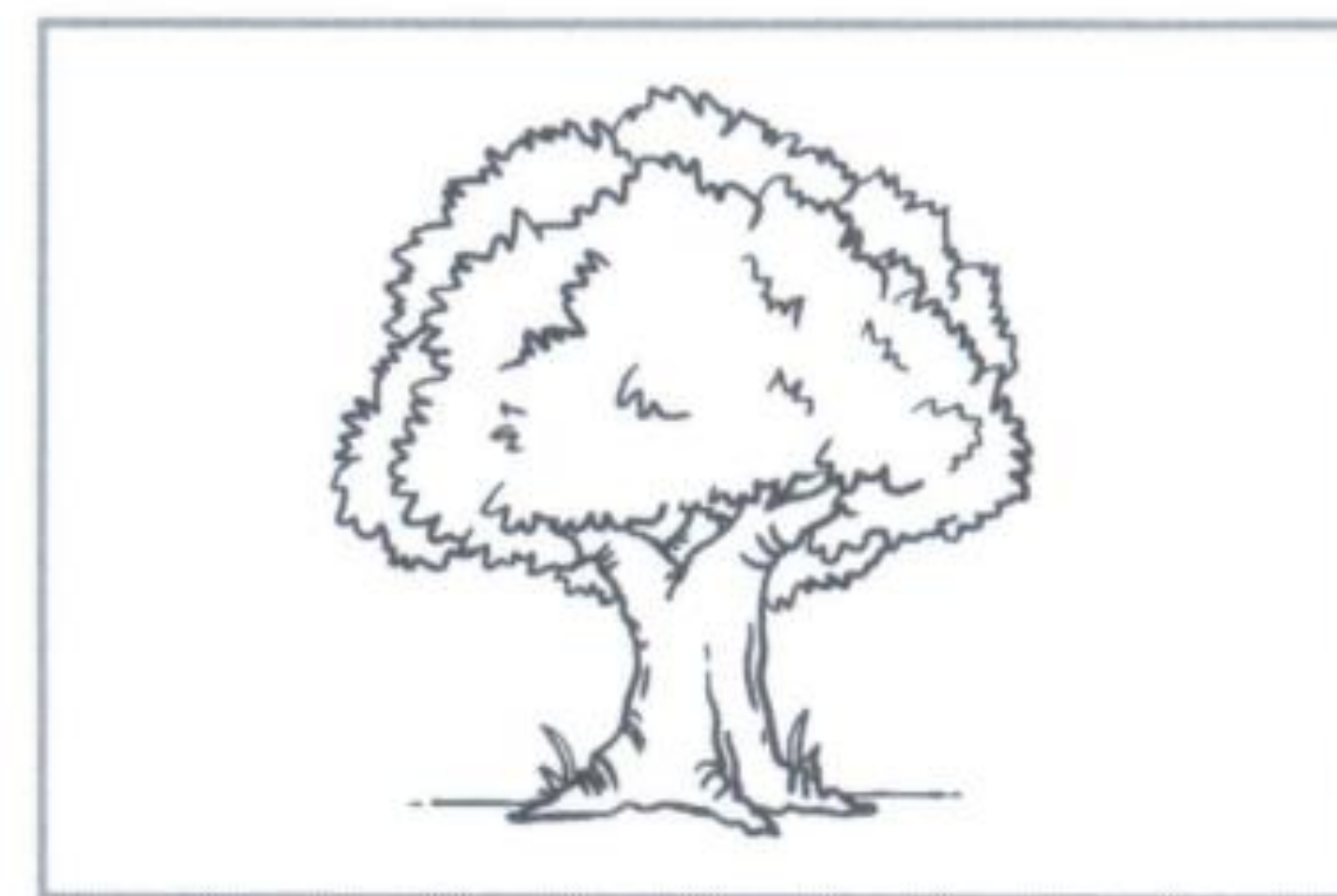

LA

VIVE NELLO



IL

DORME NELLA

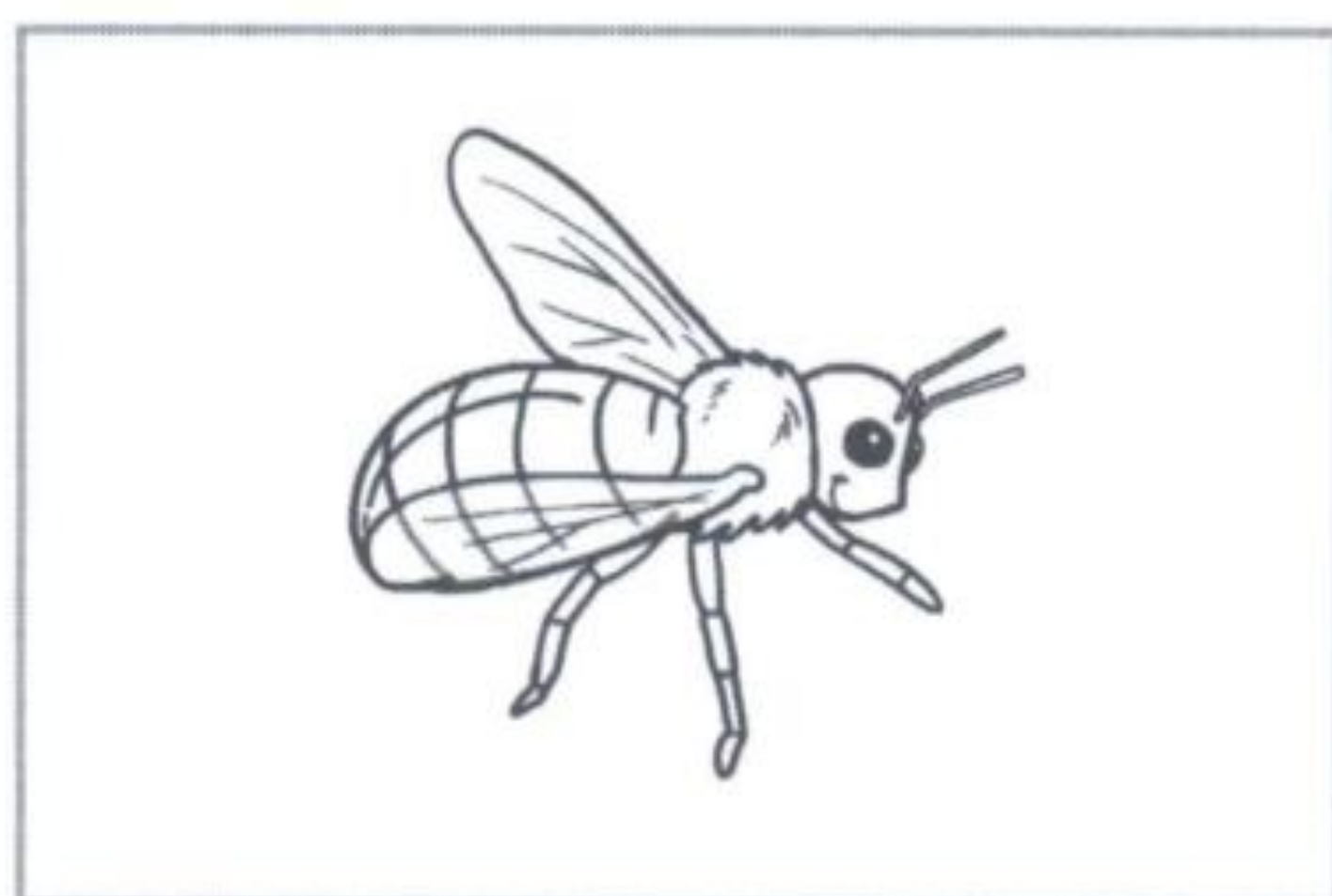
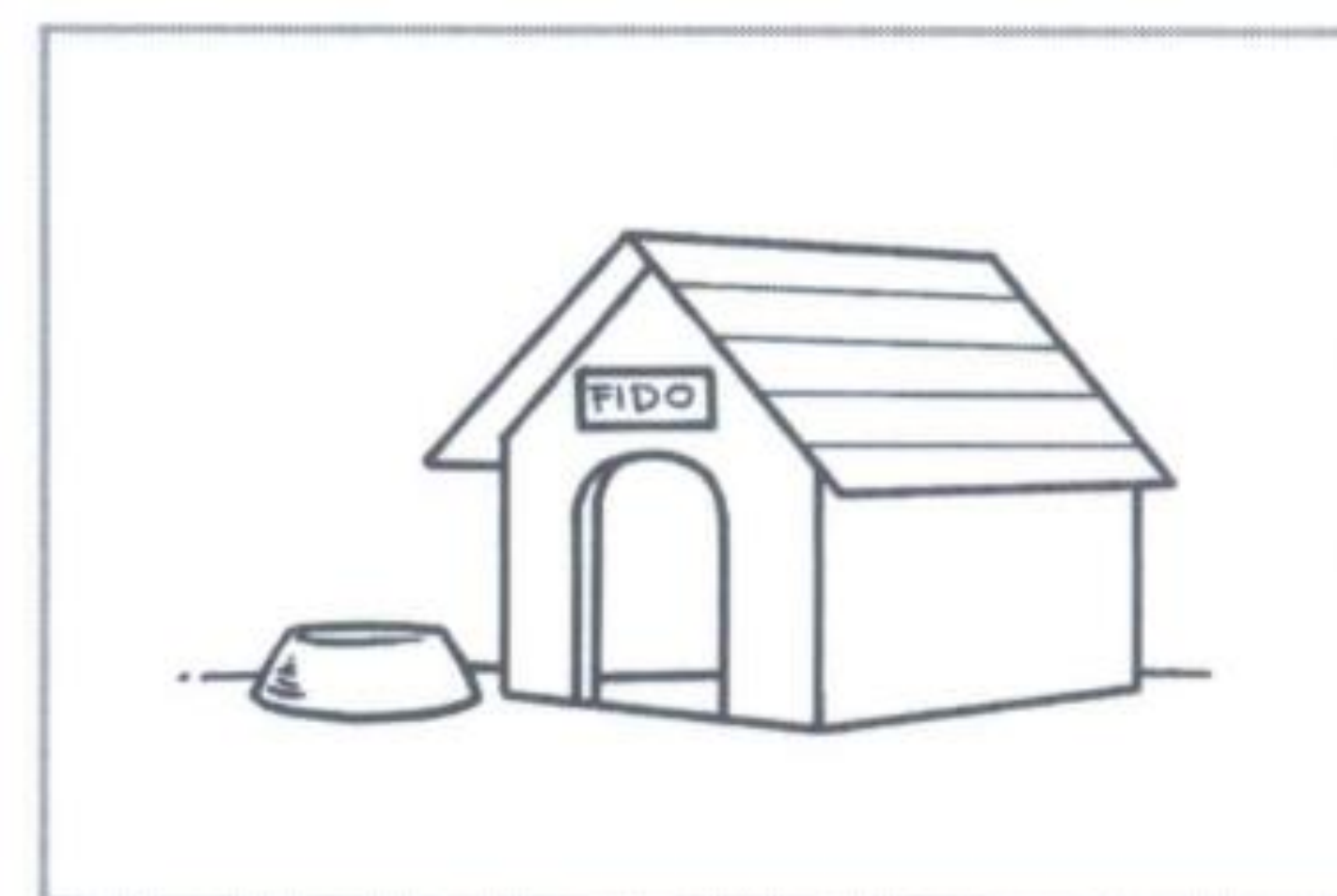

L'

VOLA SUI





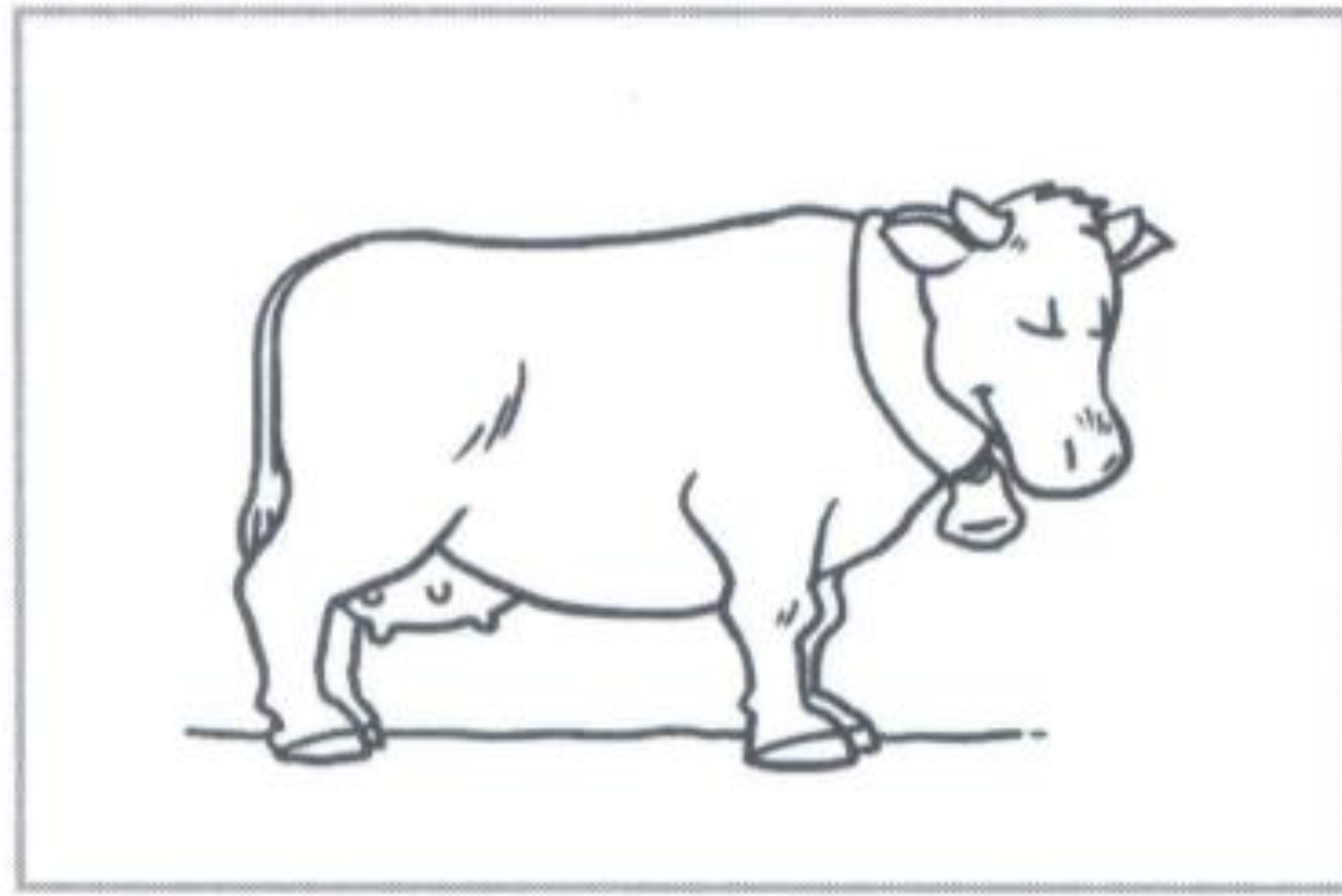

La

mangia l'

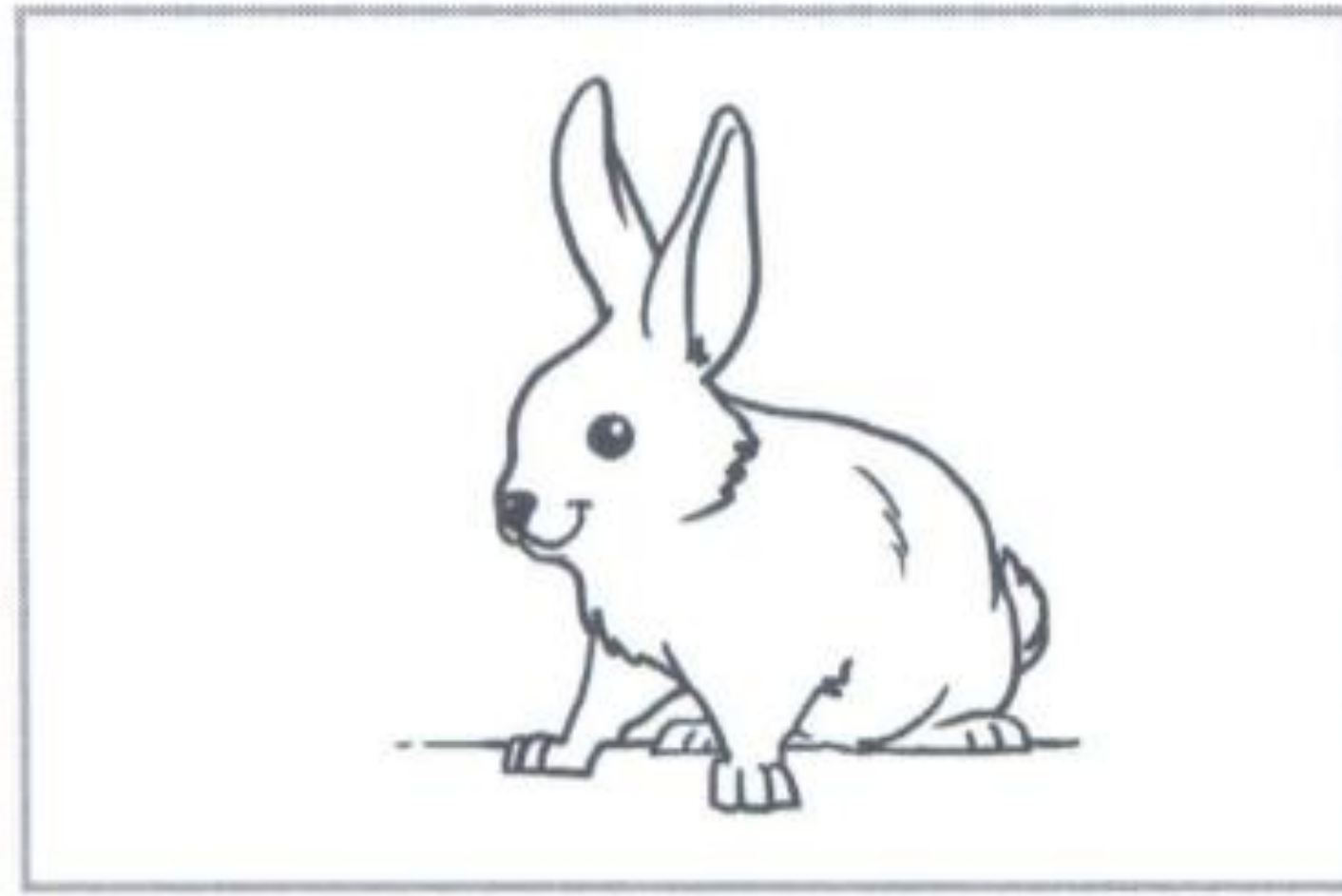
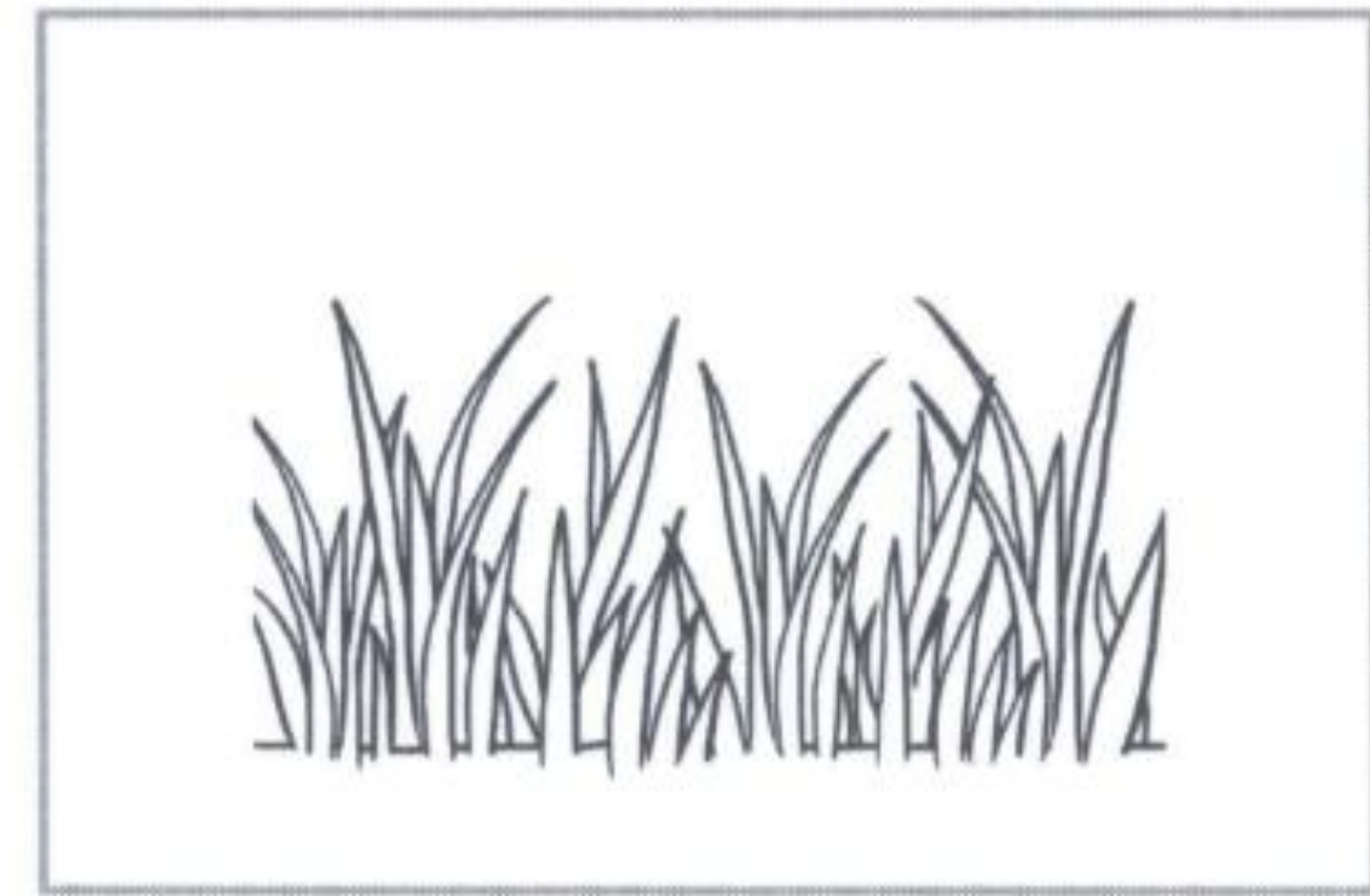

Il

mangia la



La

mangia la

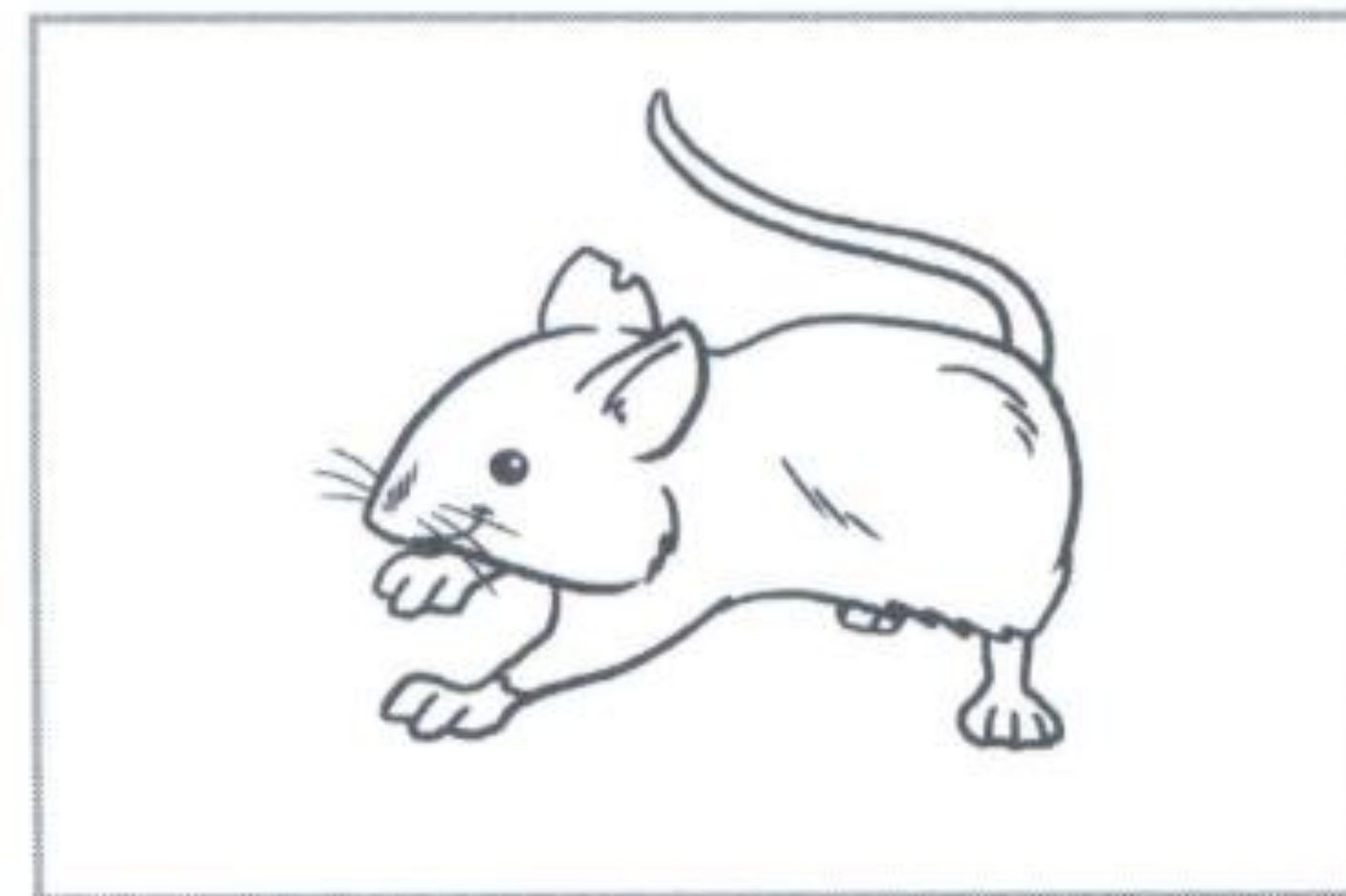
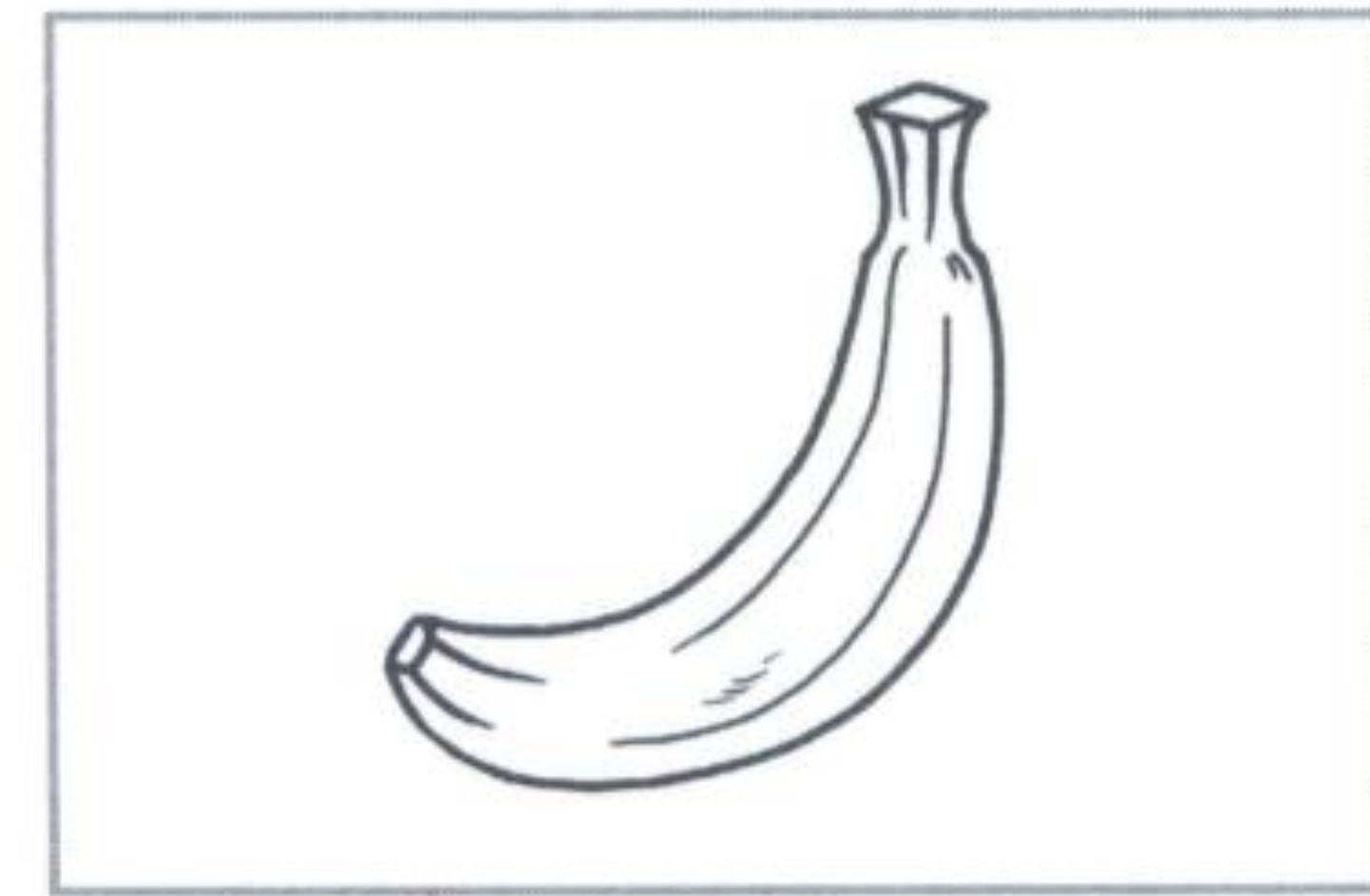

Il

mangia il

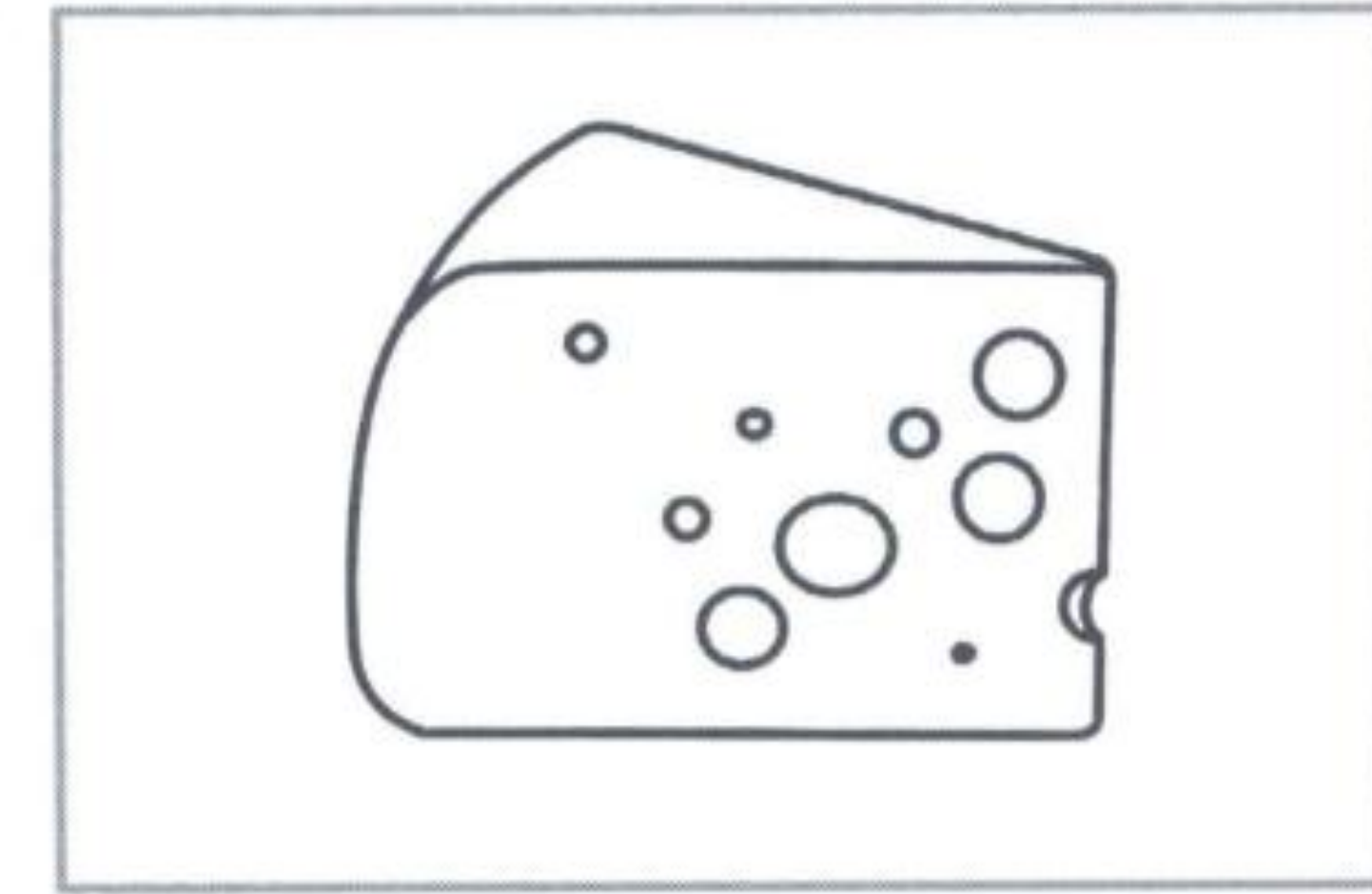

Il

mangia l'

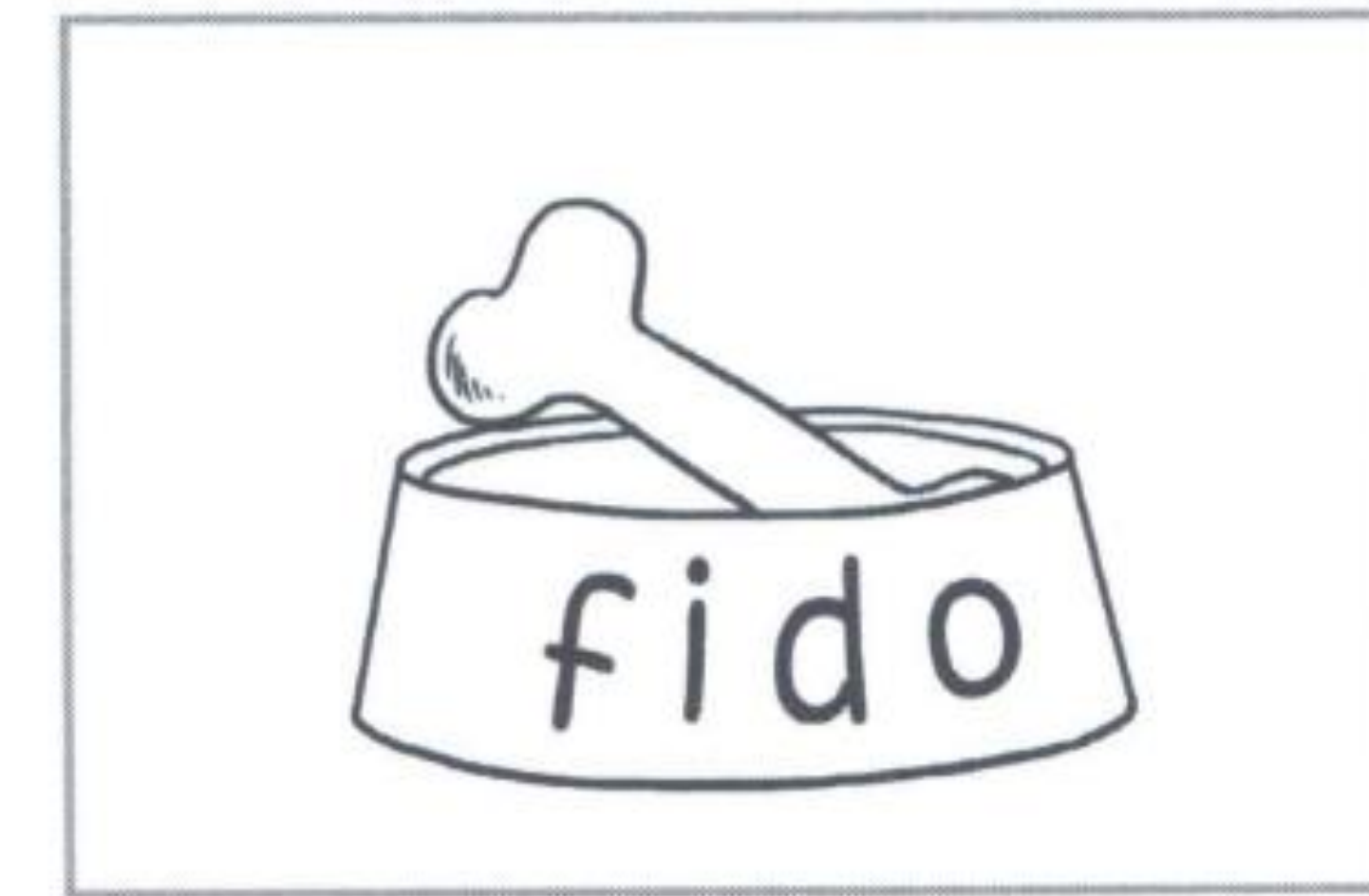



OSSERVA I DISEGNI E RISCRIVI SOTTO TUTTA LA  
FRASE IN STAMPATO MAIUSCOLO



LA		PREPARA UNA	
----	--	-------------	--

IL		LEGGE UN	
----	--	----------	--

IL		MANGIA UN	
----	--	-----------	--

LA		SUONA IL	
----	--	----------	--



LA		APRE LA	
----	--	---------	--







Il		beve l'	
----	---	---------	---

La		si lava le	
----	--	------------	--

Il		va a	
----	---	------	---

Il		stira la	
----	---	----------	---

La		si allaccia le	
----	---	----------------	---



OSSERVA I DISEGNI, INSERISCI IL SOGGETTO E  
RISCRIVI TUTTA LA FRASE IN STAMPATO MAIUSCOLO



IL \_\_\_\_\_ FA I DOLCI

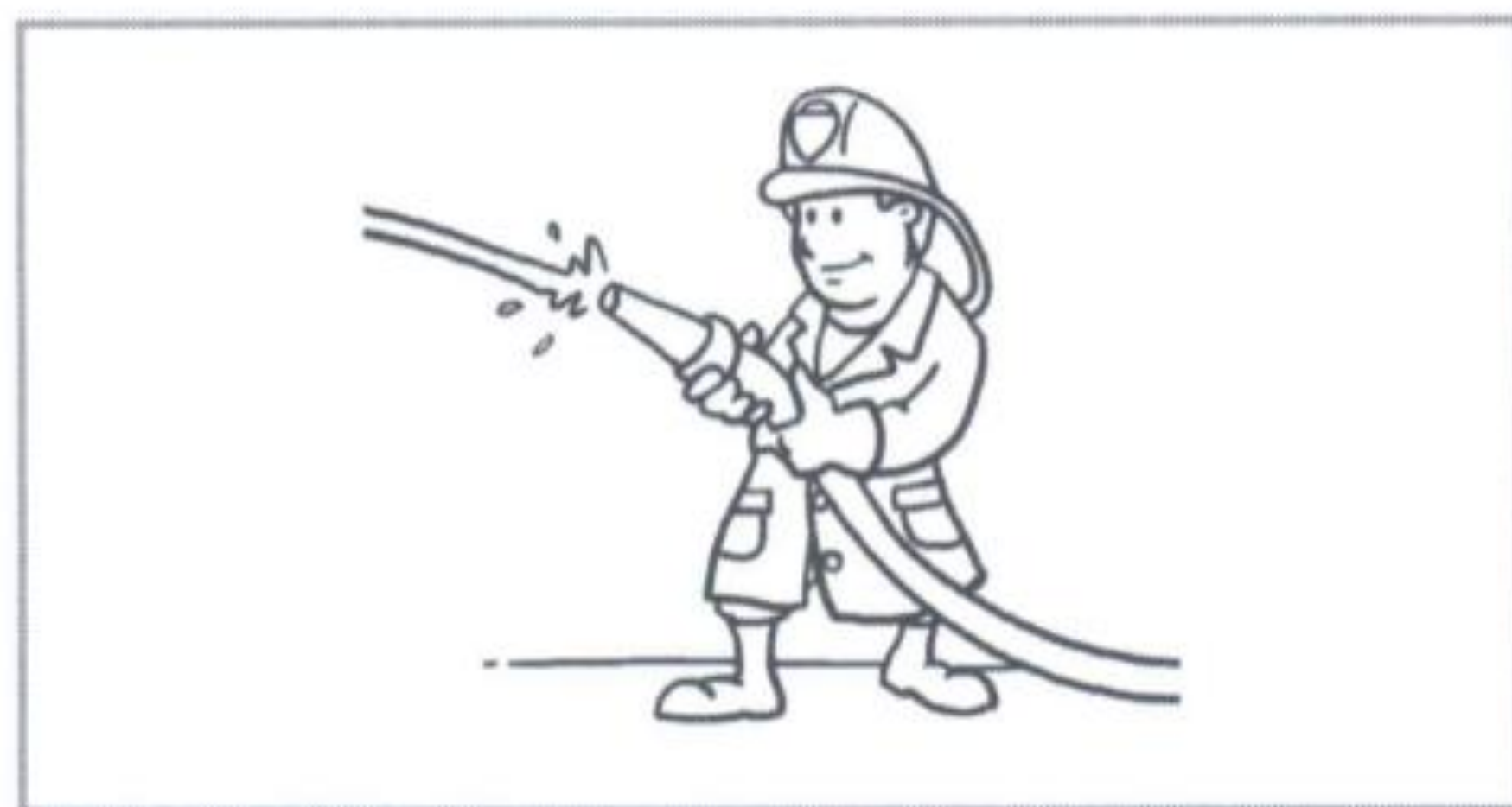

IL \_\_\_\_\_ SPEGNE IL FUOCO



IL \_\_\_\_\_ GUIDA GLI AEREI



IL \_\_\_\_\_ AGGIUSTA LE MACCHINE





La \_\_\_\_\_ scrive sulla lavagna

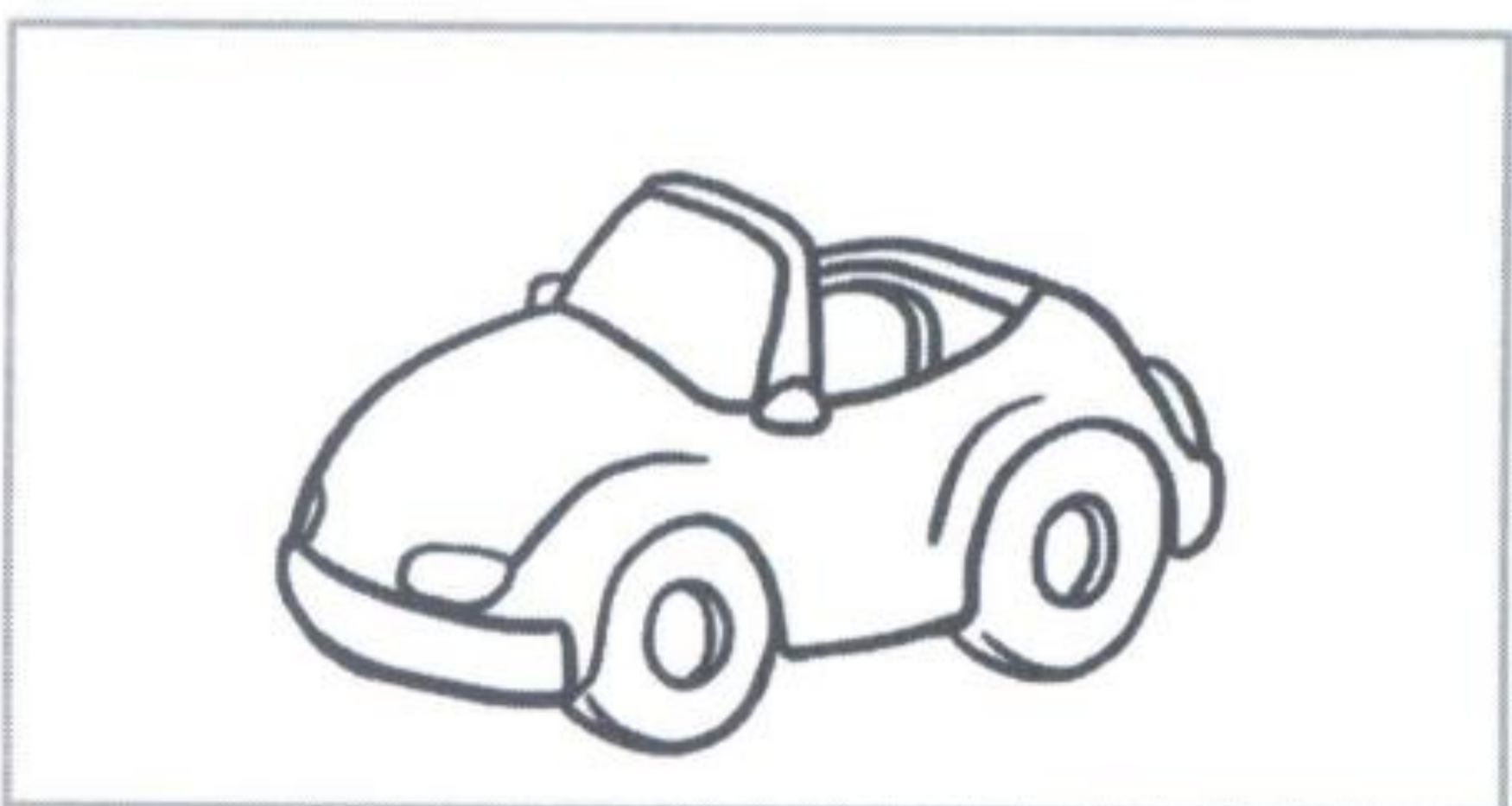

La \_\_\_\_\_ corre sulla strada

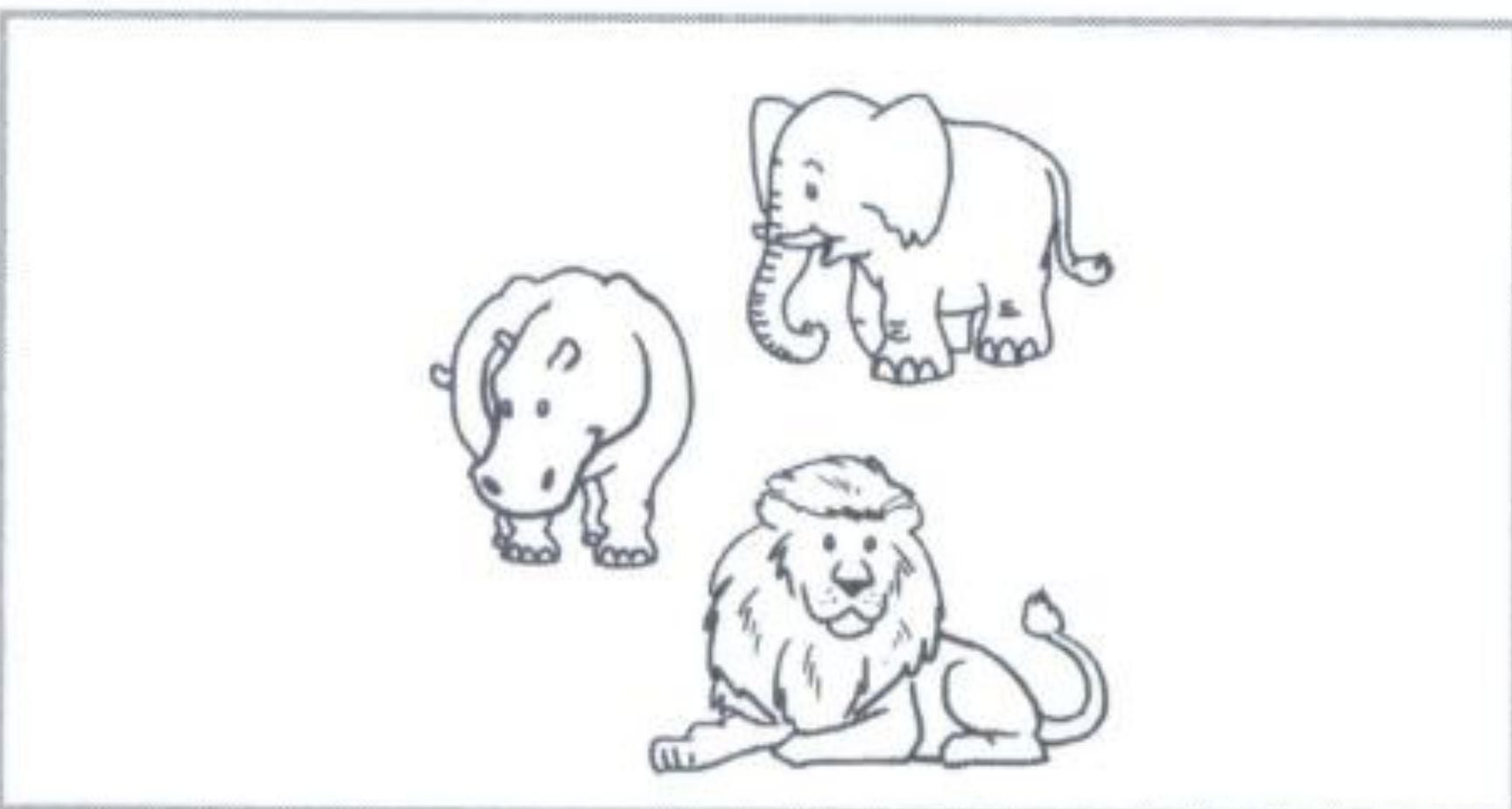

Gli \_\_\_\_\_ vivono nello zoo

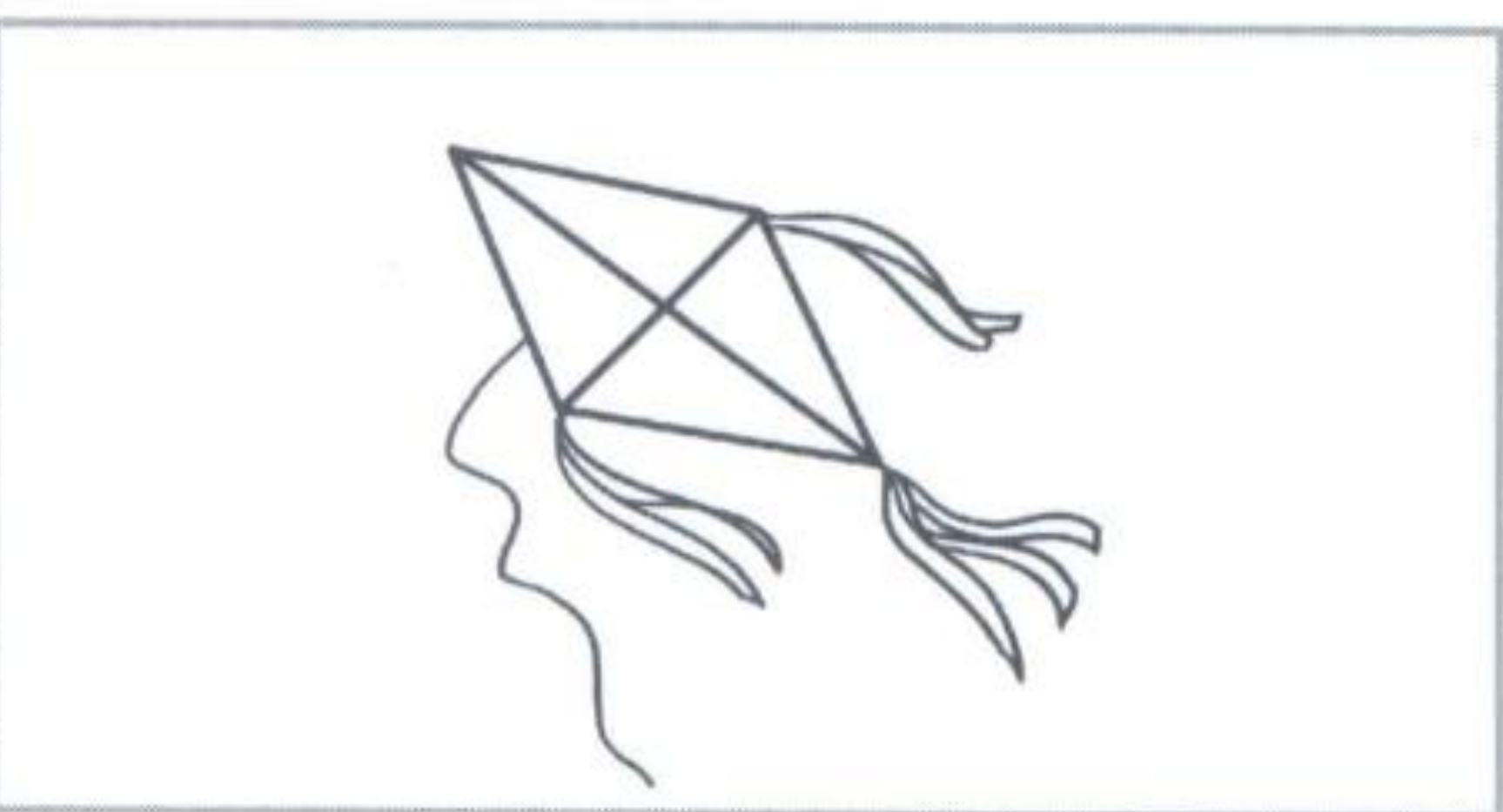

L' \_\_\_\_\_ vola nel cielo



OSSERVA I DISEGNI, INSERISCI IL VERBO E RISCRIVI  
LA FRASE IN STAMPATO MAIUSCOLO

SCHEDA  
104



IL GIARDINIERE \_\_\_\_\_ I FIORI

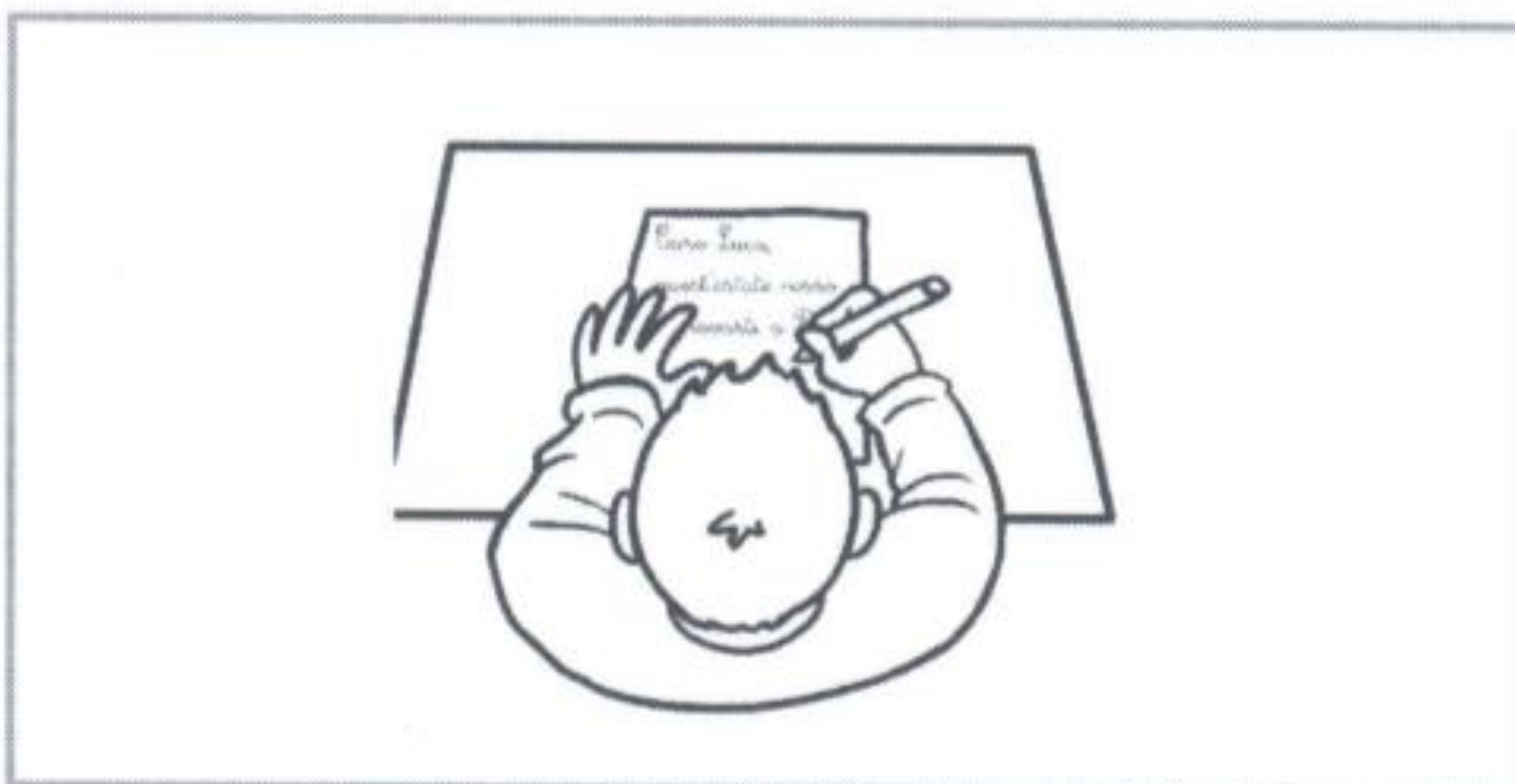

IL BAMBINO \_\_\_\_\_ CON LA PENNA



LO ZIO \_\_\_\_\_ PER TERRA



IL MUSICISTA \_\_\_\_\_ LA TROMBA



La bambina \_\_\_\_\_ il libro

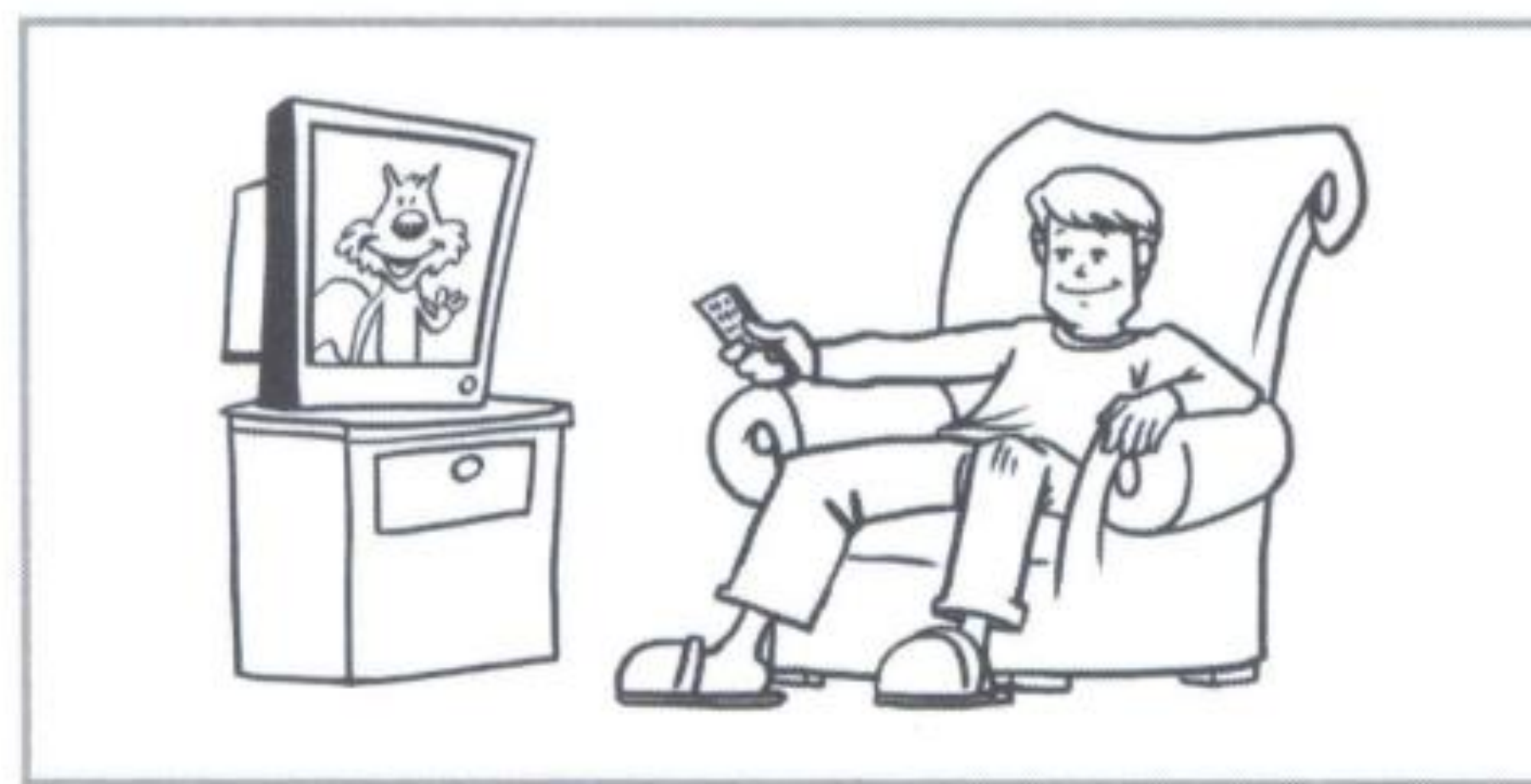

Il ragazzo \_\_\_\_\_ la televisione



Il bambino \_\_\_\_\_ i fiori

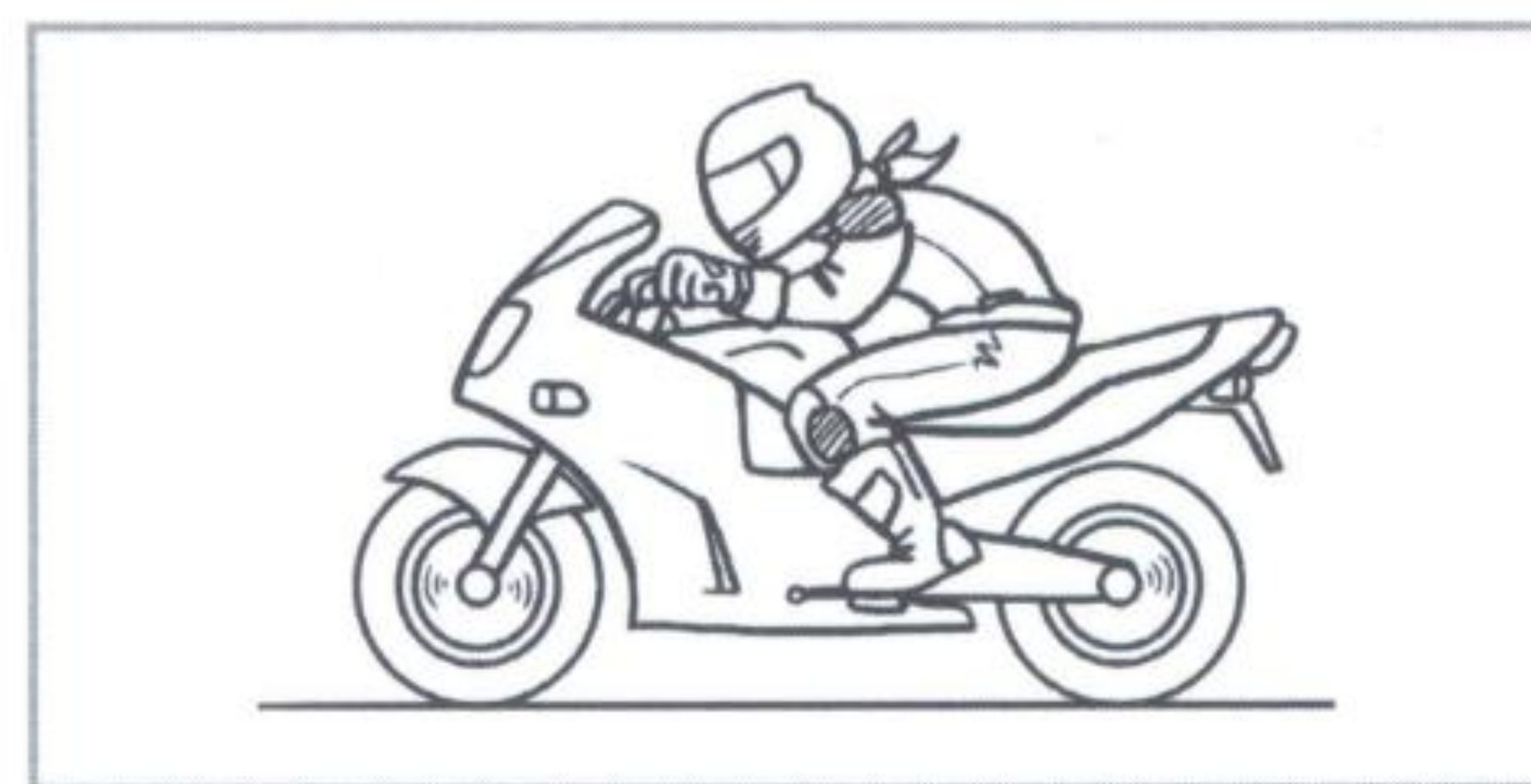

Il signore \_\_\_\_\_ la moto



OSSERVA I DISEGNI, INSERISCI IL COMPLEMENTO E  
RISCRIVI LA FRASE IN STAMPATO MAIUSCOLO

SCHEDA  
106

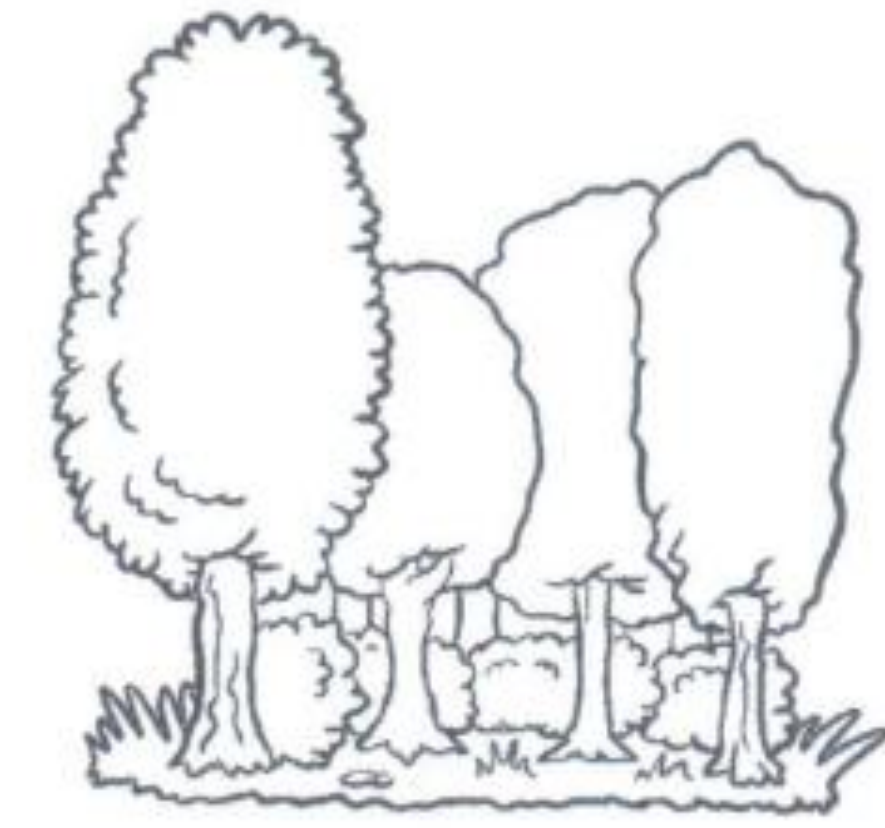

LE FOGLIE CADONO DAGLI \_\_\_\_\_



IL RAGAZZO SI METTE IL \_\_\_\_\_



LA BAMBINA ACCAREZZA IL \_\_\_\_\_



IL SIGNORE APRE L' \_\_\_\_\_



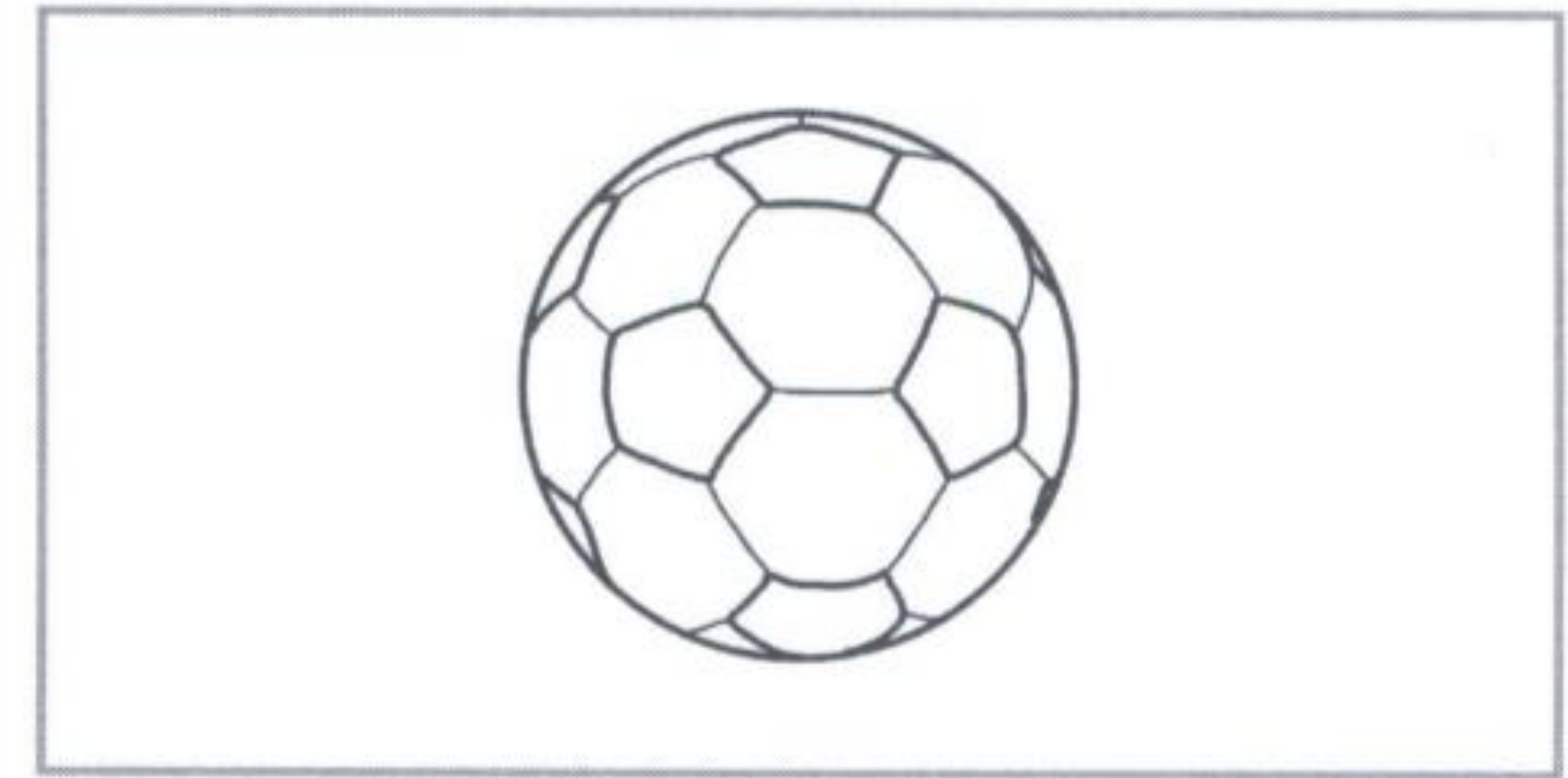

Il bambino tira il \_\_\_\_\_



La bambina gioca con la \_\_\_\_\_



Il nonno ascolta la \_\_\_\_\_

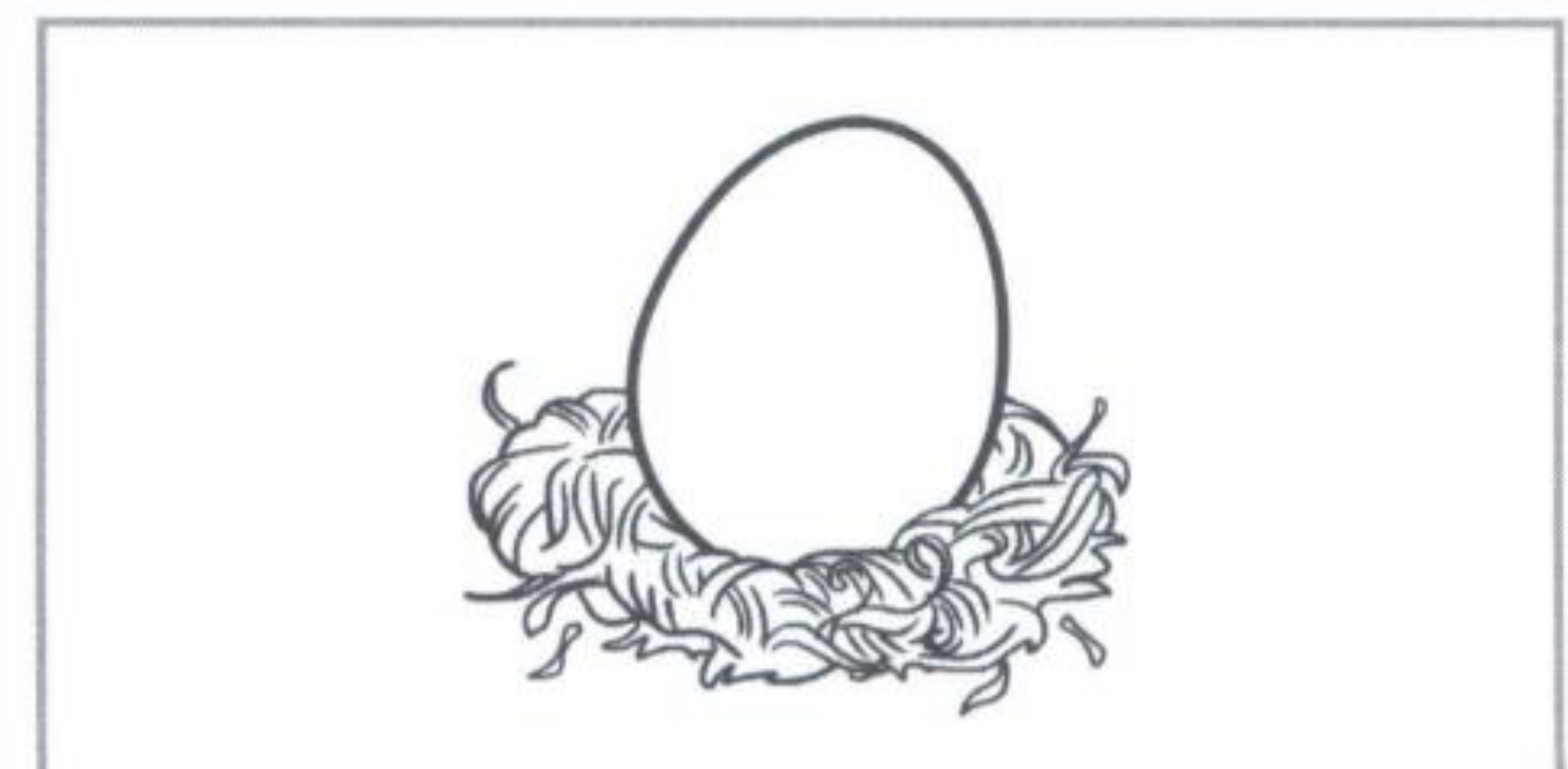







La gallina fa l' \_\_\_\_\_







COLLEGA SOGGETTO, VERBO E COMPLEMENTO IN MODO DA FORMARE DELLE FRASI DI SENSO COMPIUTO

SCHEDA  
108

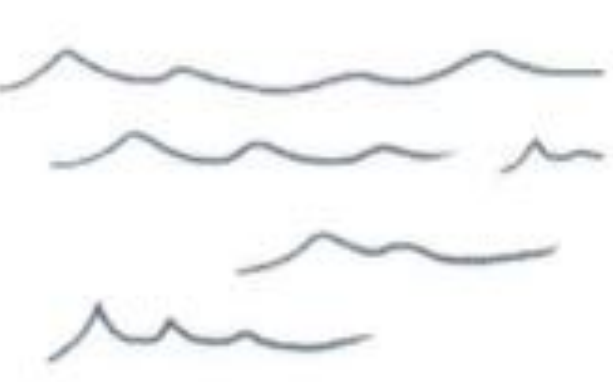
	IL PAPÀ	VENDE	IL MIELE	
	L'ORSO	LAVORA	LA CARNE	
	IL MACELLAIO	MANGIA	AL COMPUTER	

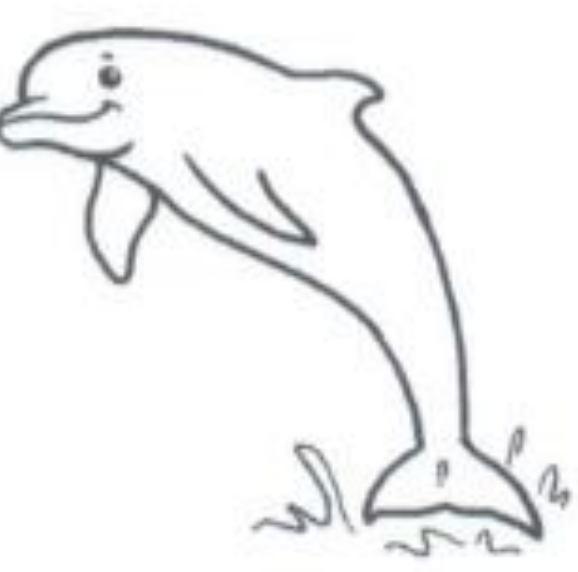
Arrows indicate connections: from 'IL PAPÀ' to 'LAVORA', and from 'LAVORA' to 'AL COMPUTER'.

	IL GATTO	CRESCONO	NELL'OCEANO	
	LE MELE	NUOTA	SULLA POLTRONA	
	IL DELFINO	DORME	SULL'ALBERO	





SOFFIA

BAMBINO

IL



BAMBINO

IL

MANGIA



IL

TAGLIA

RAGAZZO



CUCE

SARTA

LA



OSSERVA I DISEGNI E RIMETTI IN ORDINE LE PAROLE FORMANDO UNA FRASE

SCHEDA  
110



FIORI

SONO

PROFUMATI

I

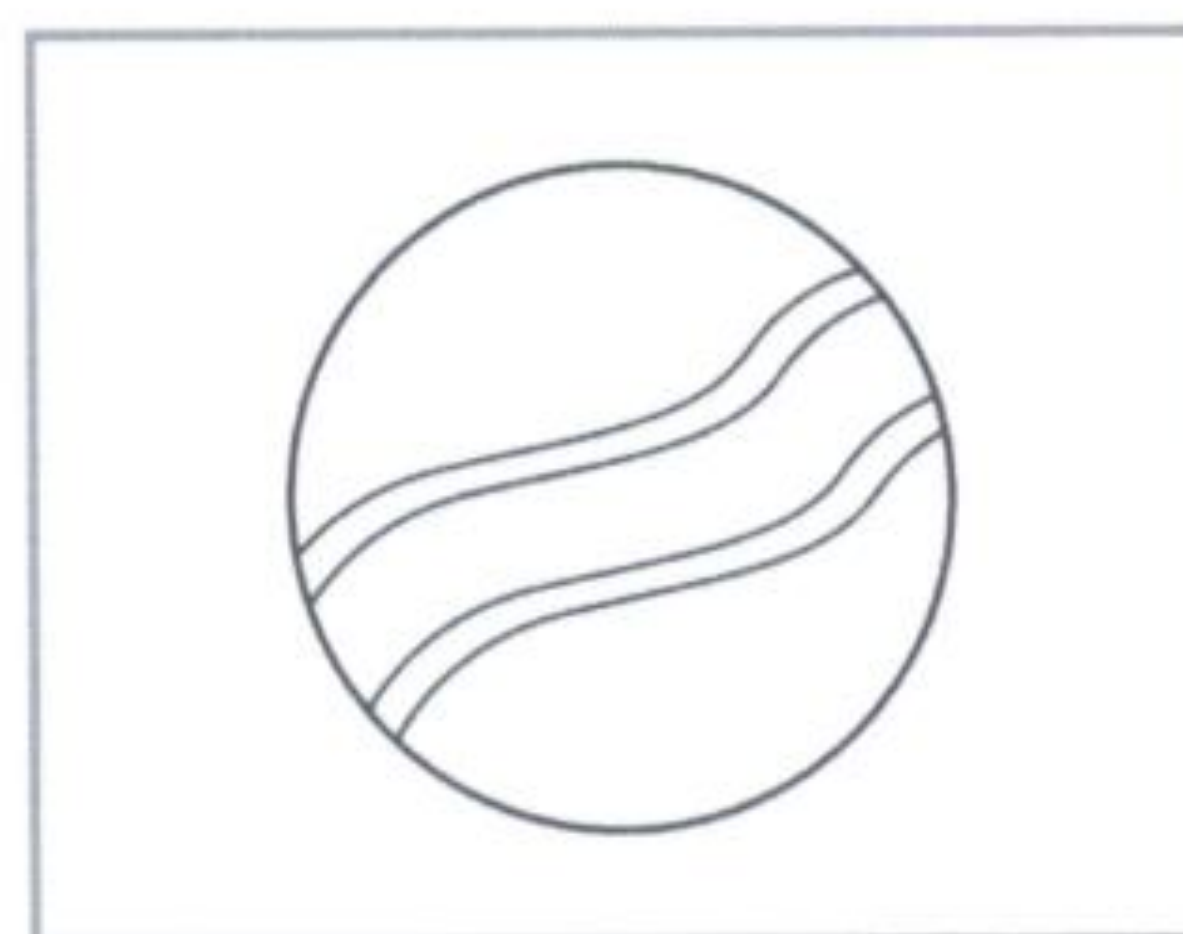

ROTONDA

PALLA

È

LA

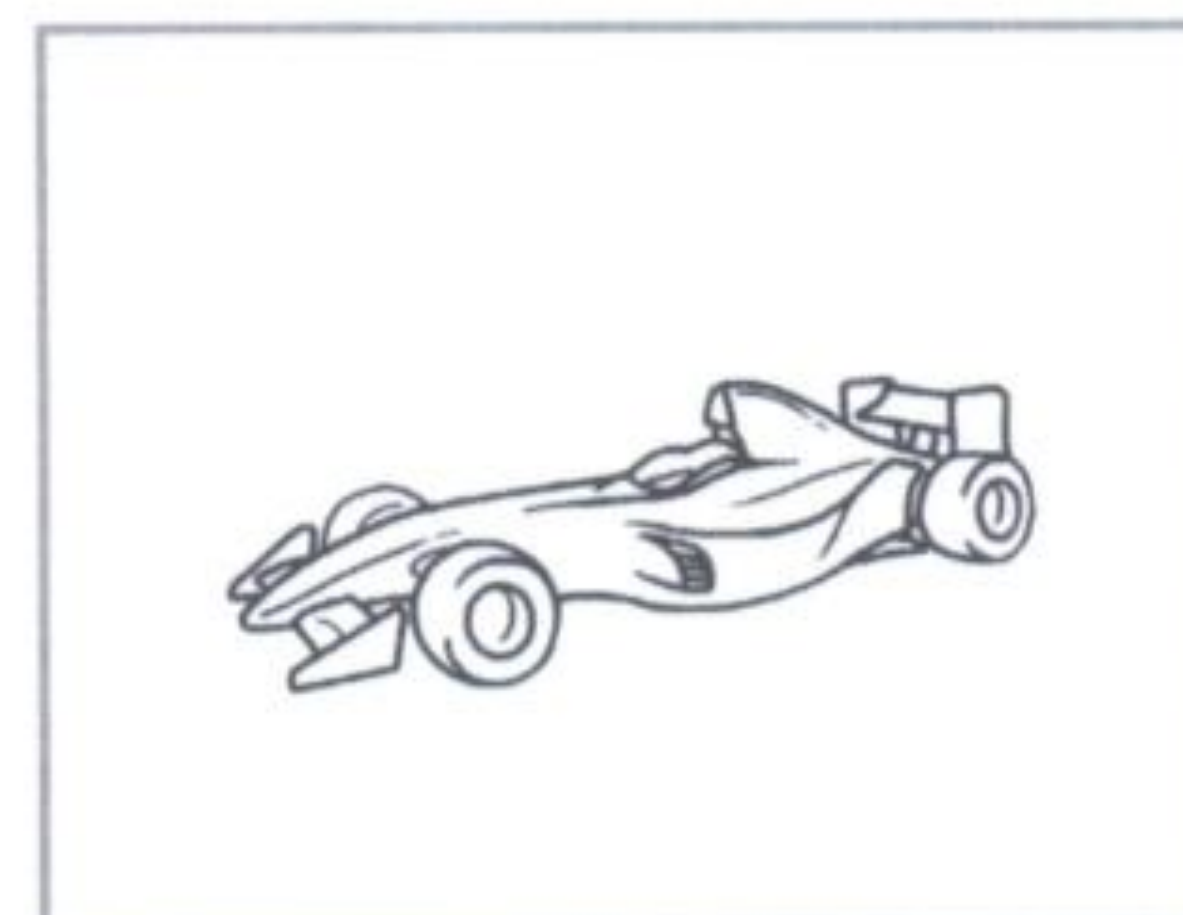

VA

LA

MACCHINA

VELOCE



ARRABBIATO

IL

BAMBINO

È



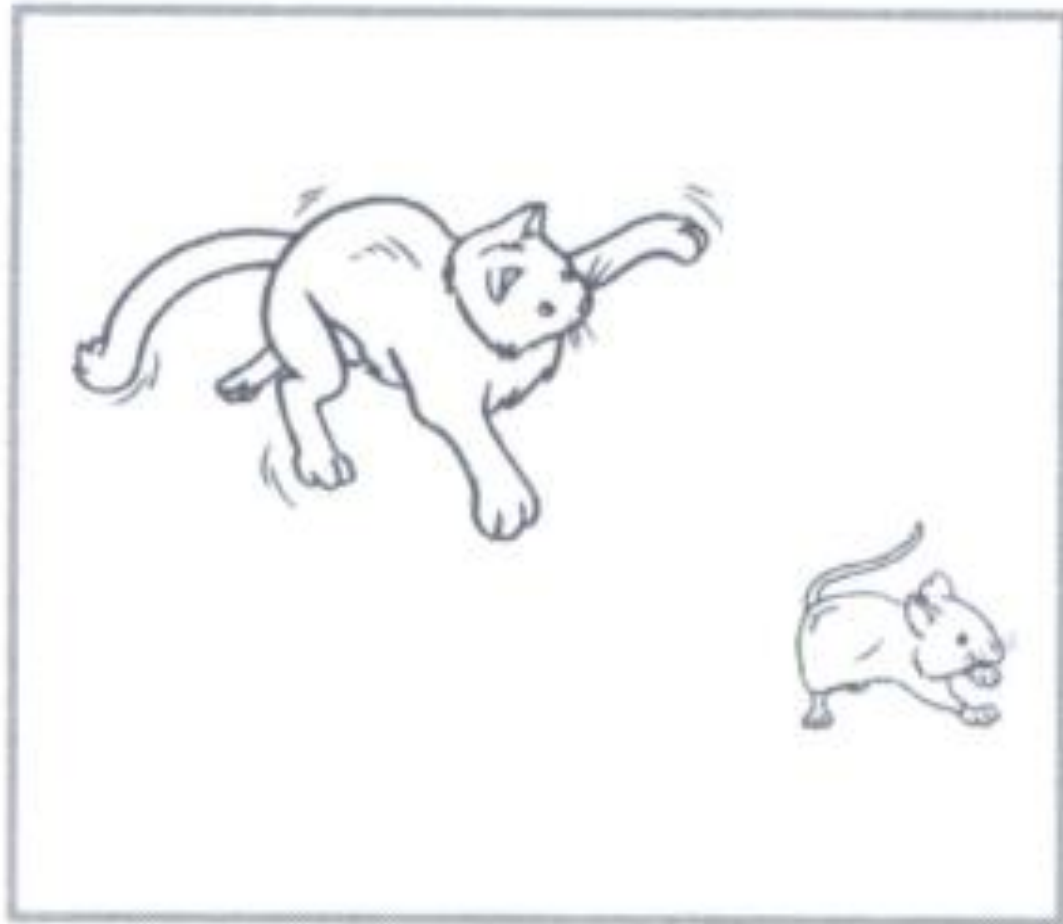

GATTO

IL

TOPO

IL

INSEGUE



FIORE

LA

È

MARGHERITA

UN

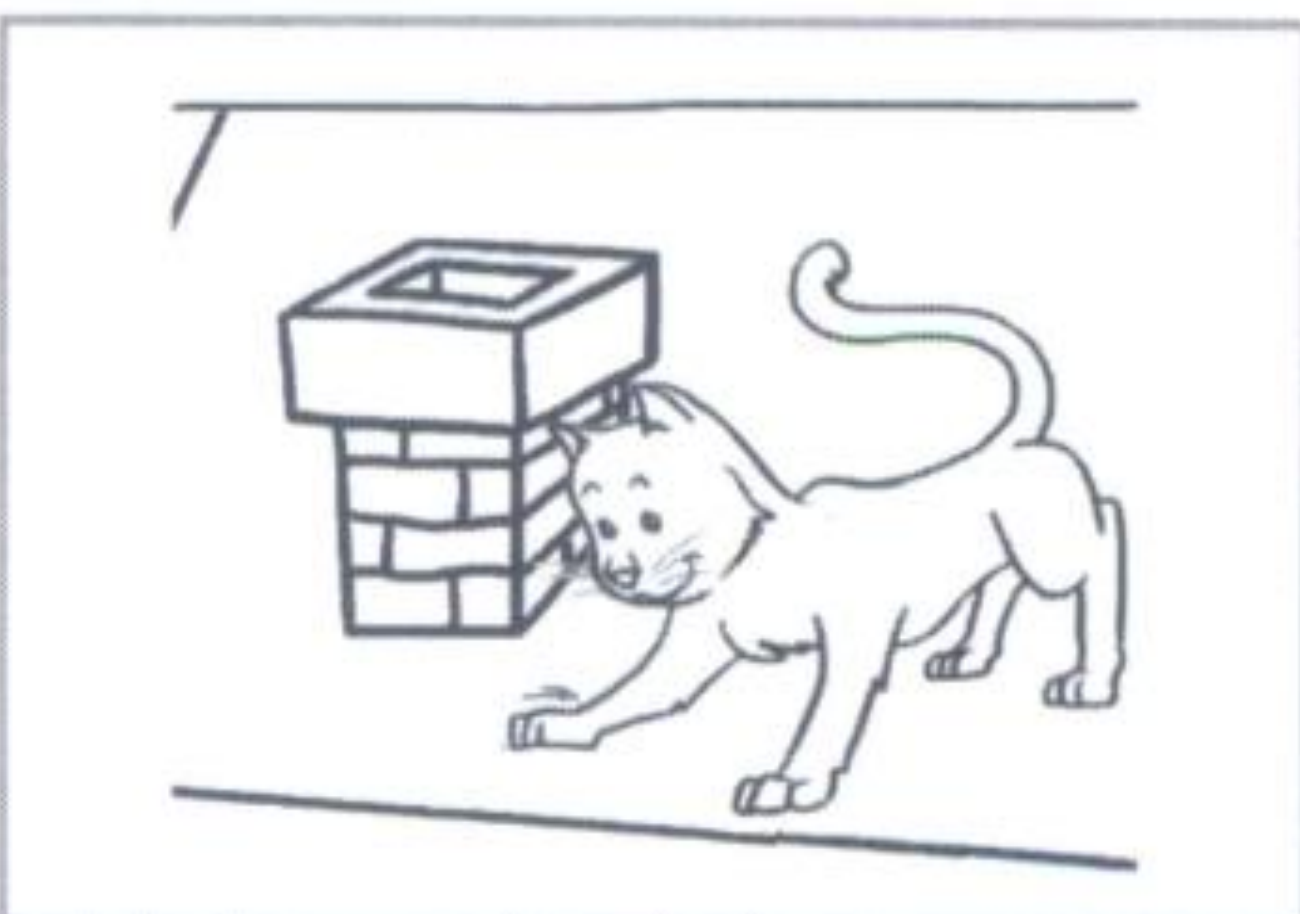

CAMMINA

TETTO

GATTO

IL

SUL



NELLO

QUADERNO

ZAINO

È

IL



SCRIVI IN ALTO IL NOME DI CHI COMPIE QUESTE AZIONI



## CHI È?

[Blank space for writing]

SPLENDE

TRAMONTA

SORGE

[Blank space for writing]

GRACCHIA

SALTA

NUOTA

[Blank space for writing]

SBOCCIA

PROFUMA

APPASSISCE

[Blank space for writing]

MIAGOLA

GRAFFIA

SOFFIA

[Blank space for writing]

RONZA

PUNGE

VOLA

[Blank space for writing]

NUOTA

ABBOCCA

GUIZZA

[Blank space for writing]

DECOLLA

ATTERRA

VOLA

[Blank space for writing]

BRUCIA

RISCALDA

CUOCE

[Blank space for writing]

GATTONA

PIANGE

SUCCHIA

[Blank space for writing]

NAVIGA

ATTRACCA

SALPA

[Blank space for writing]

ABBAIA

RINGHIA

SCODINZOLA

[Blank space for writing]

MUGGISCE

PASCOLA

BRUCA





## A COSA SERVE?

LE



SERVONO PER

IL



SERVE PER

IL



SERVE PER

GLI



SERVONO PER

LA



SERVE PER

I



SERVONO PER

IL



SERVE PER



OSSERVA I DISEGNI, SCEGLI L'AZIONE GIUSTA E  
SCRIVI LA FRASE

SCHEDA  
114



CORRE

BEVE

---



RIDE

PIANGE

---



PATTINA

SCIA

---



SUONA

FISCHIA

---



DISEGNA

CUCE

---



CORRE

DORME

---





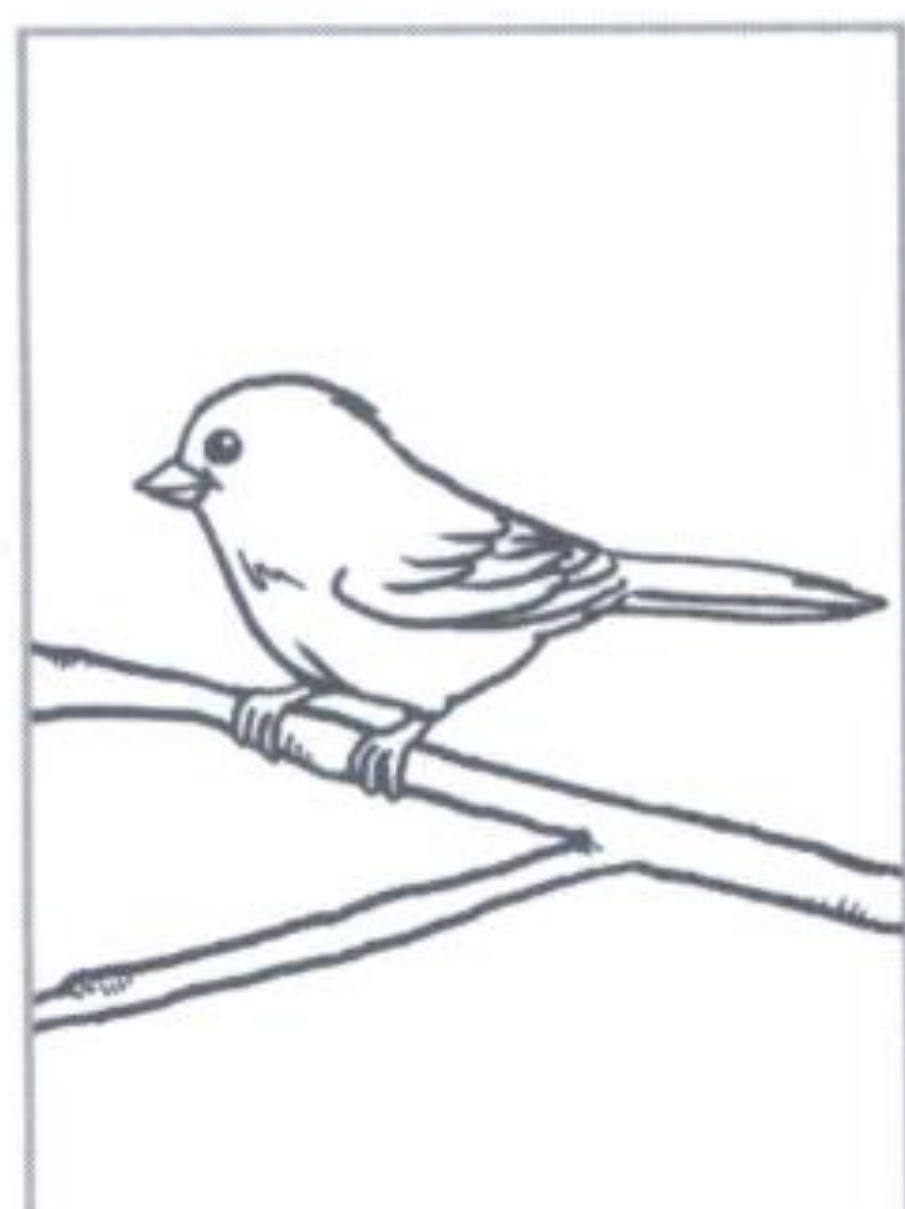

CINGUETTA

PARLA

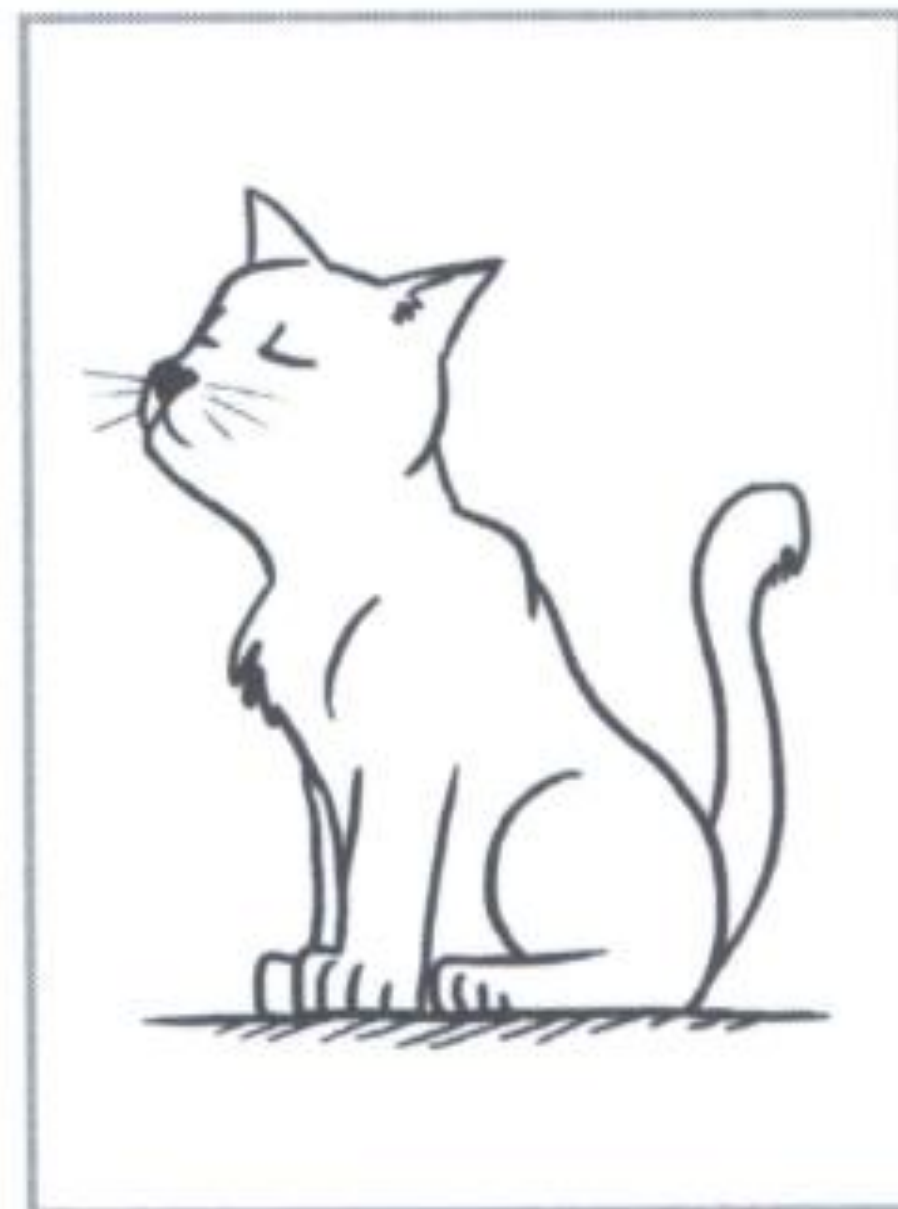

ABBAIA

MIAGOLA

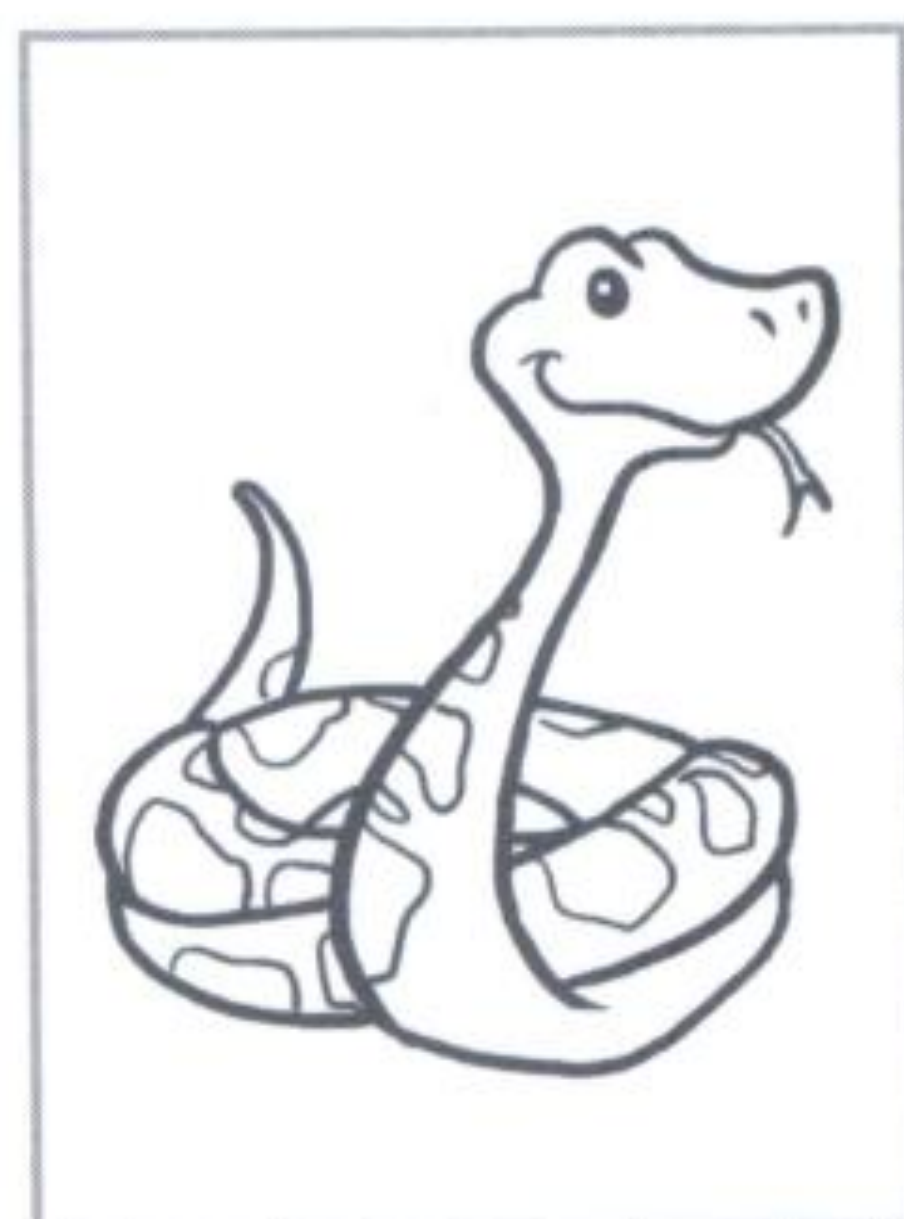

GALOPPA

STRISCIA



SALTA

VOLA

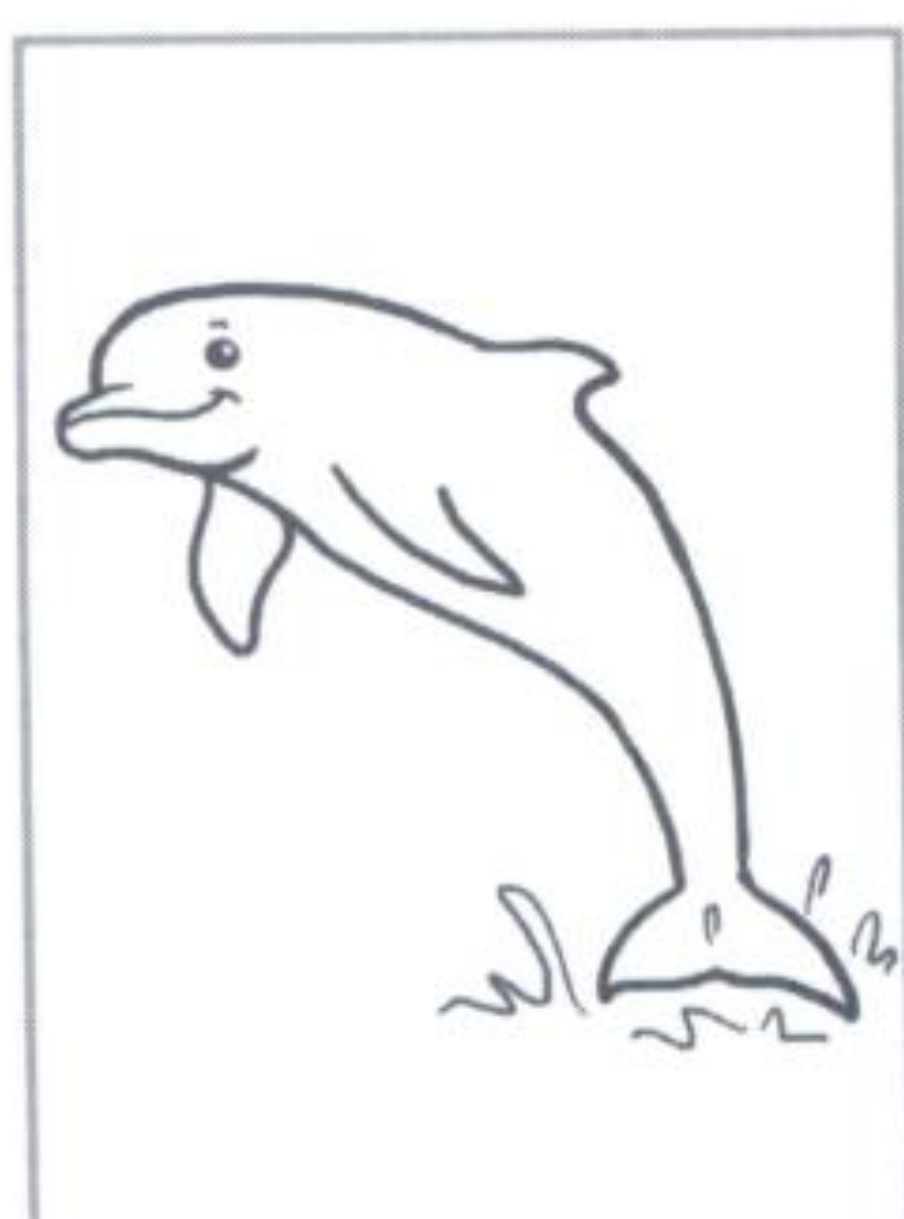

VOLA

NUOTA



RUGGISCE

MIAGOLA



OSSERVA, LEGGI, COLLEGA IL SOGGETTO AL VERBO  
CORRISPONDENTE E RISCRIVI LA FRASE



LA BALLERINA

SCIVOLANO



LA SVEGLIA

BALLA



I BAMBINI

SOFFIA

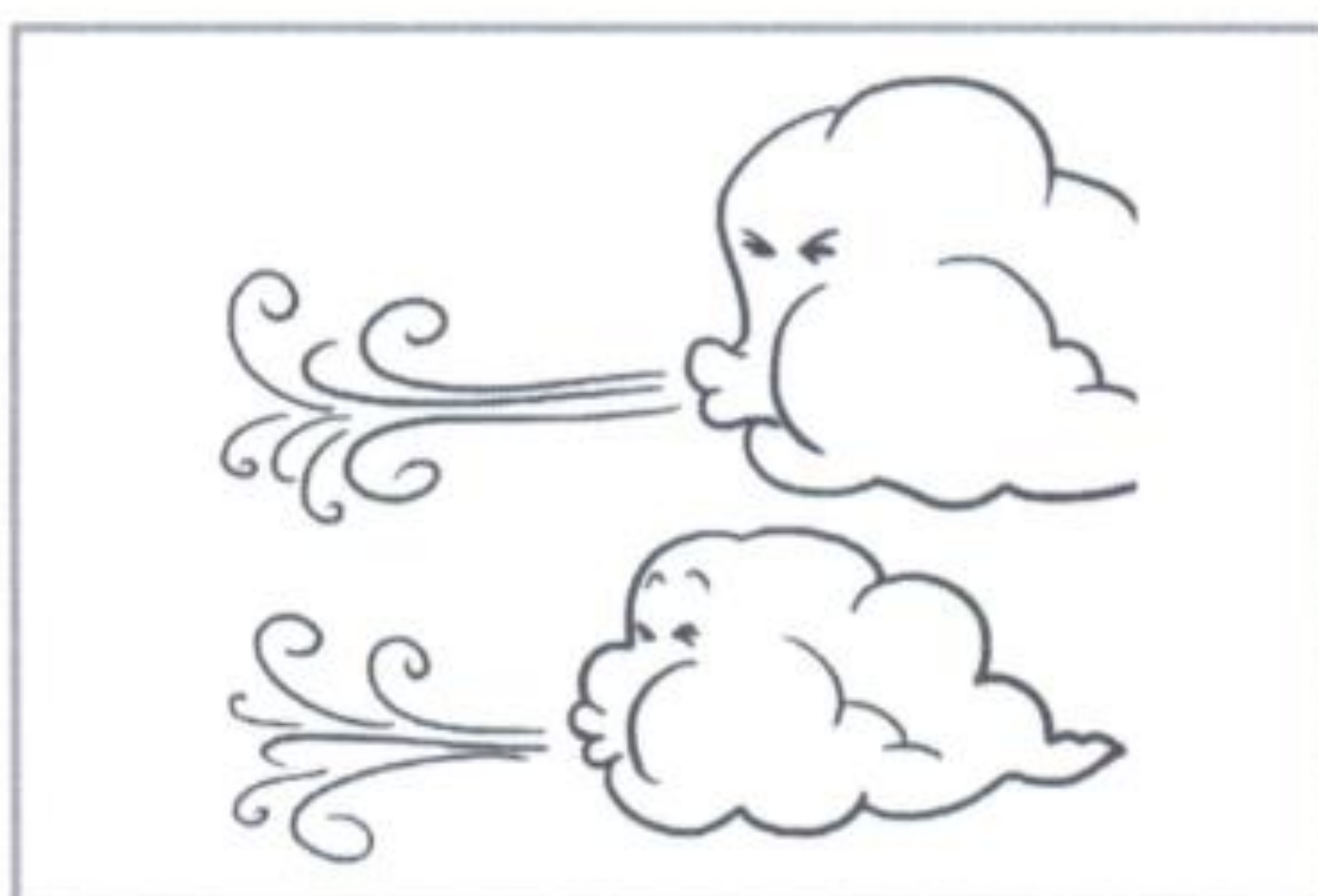

IL VENTO

SUONA

1. \_\_\_\_\_
2. \_\_\_\_\_
3. \_\_\_\_\_
4. \_\_\_\_\_





# DI CHE COLORE È?

IL

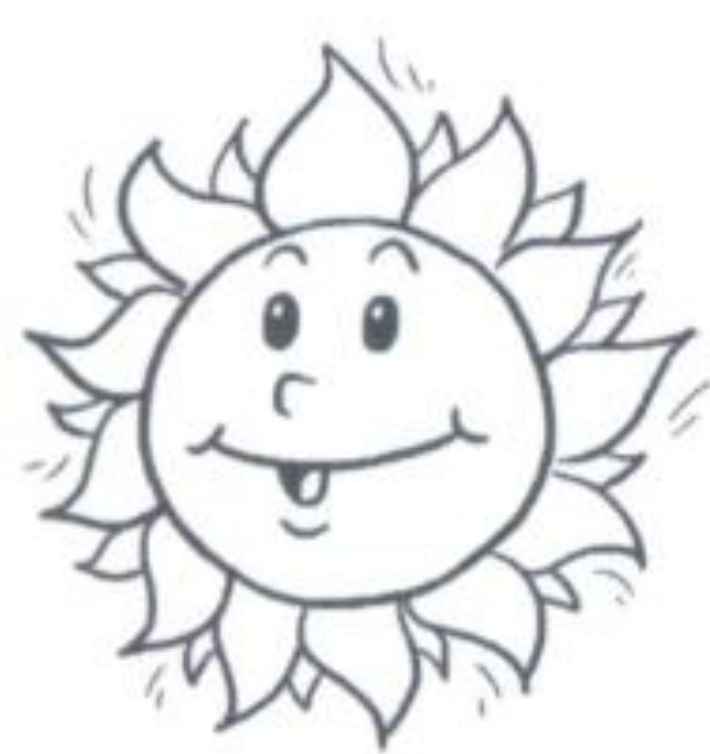

È

LA



È

IL



È

LA



È

LA



È

IL

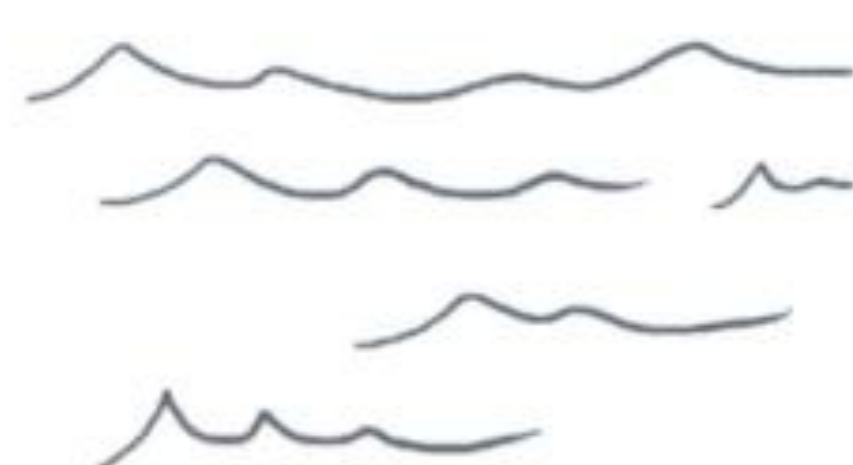

È

LA



È





SCRIVI SOTTO AD OGNI DISEGNO LA PAROLA CHE LO DESCRIVE MEGLIO, SCEGLIENDO TRA QUELLE QUI SOTTO

SCHEDA  
118

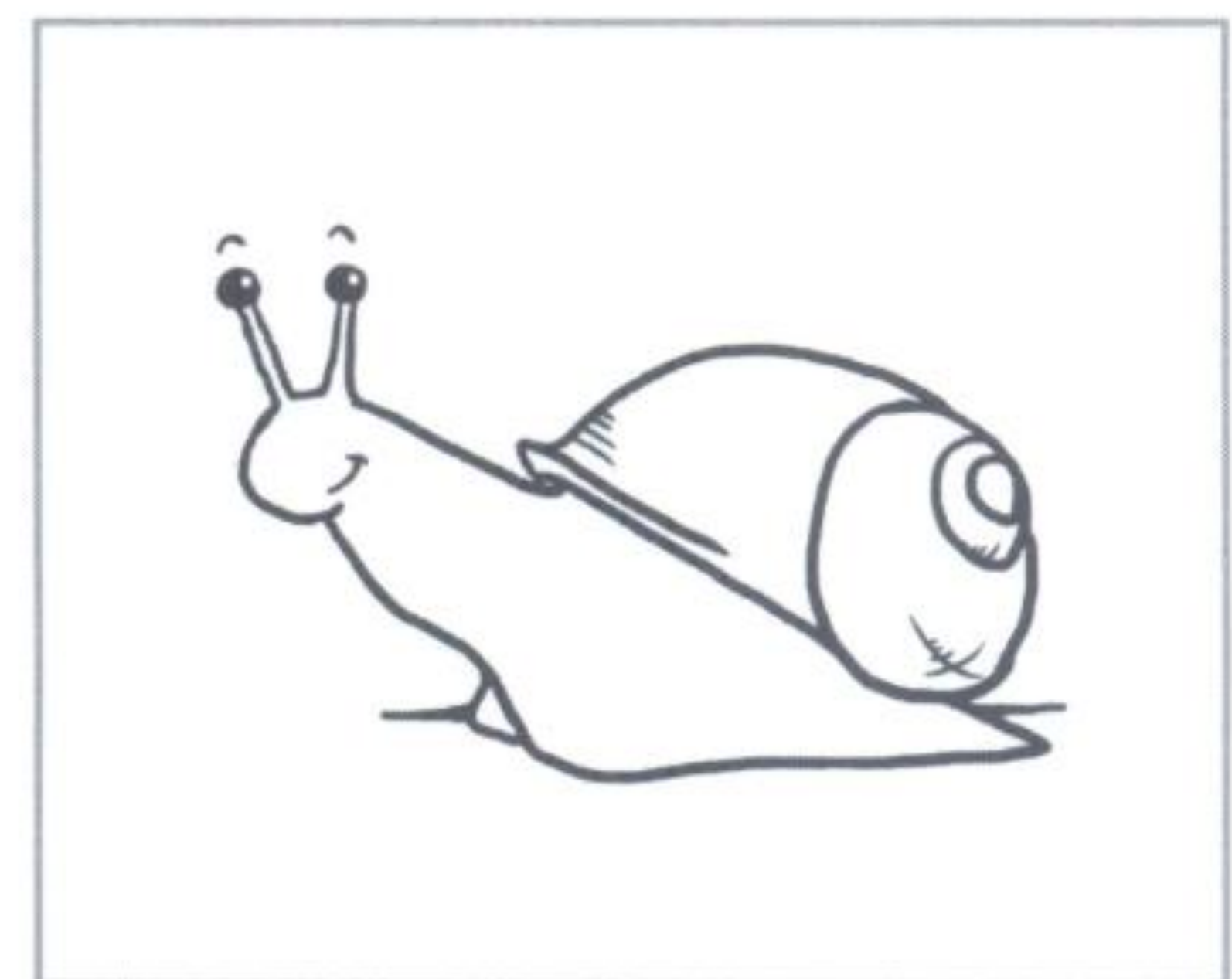
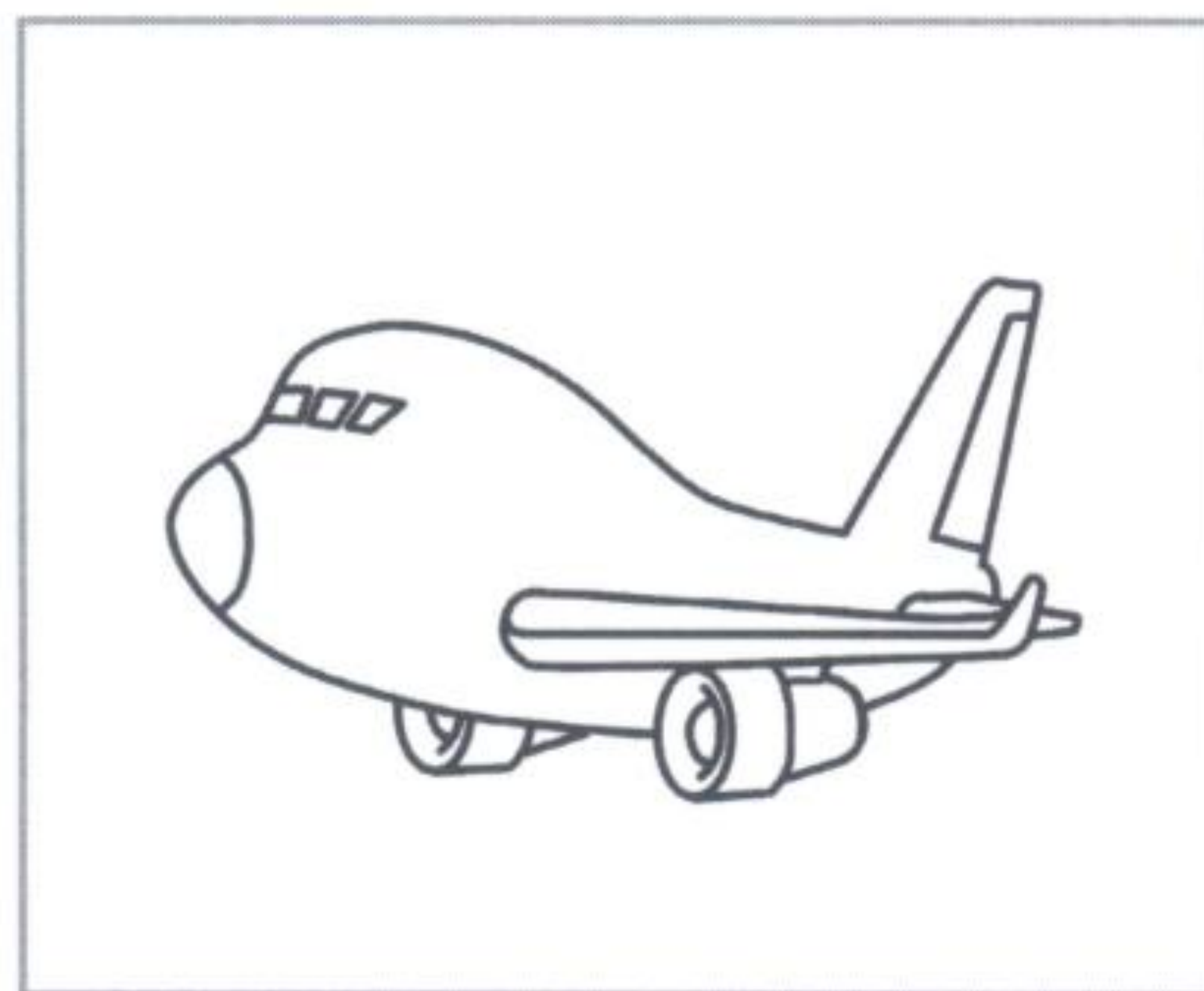
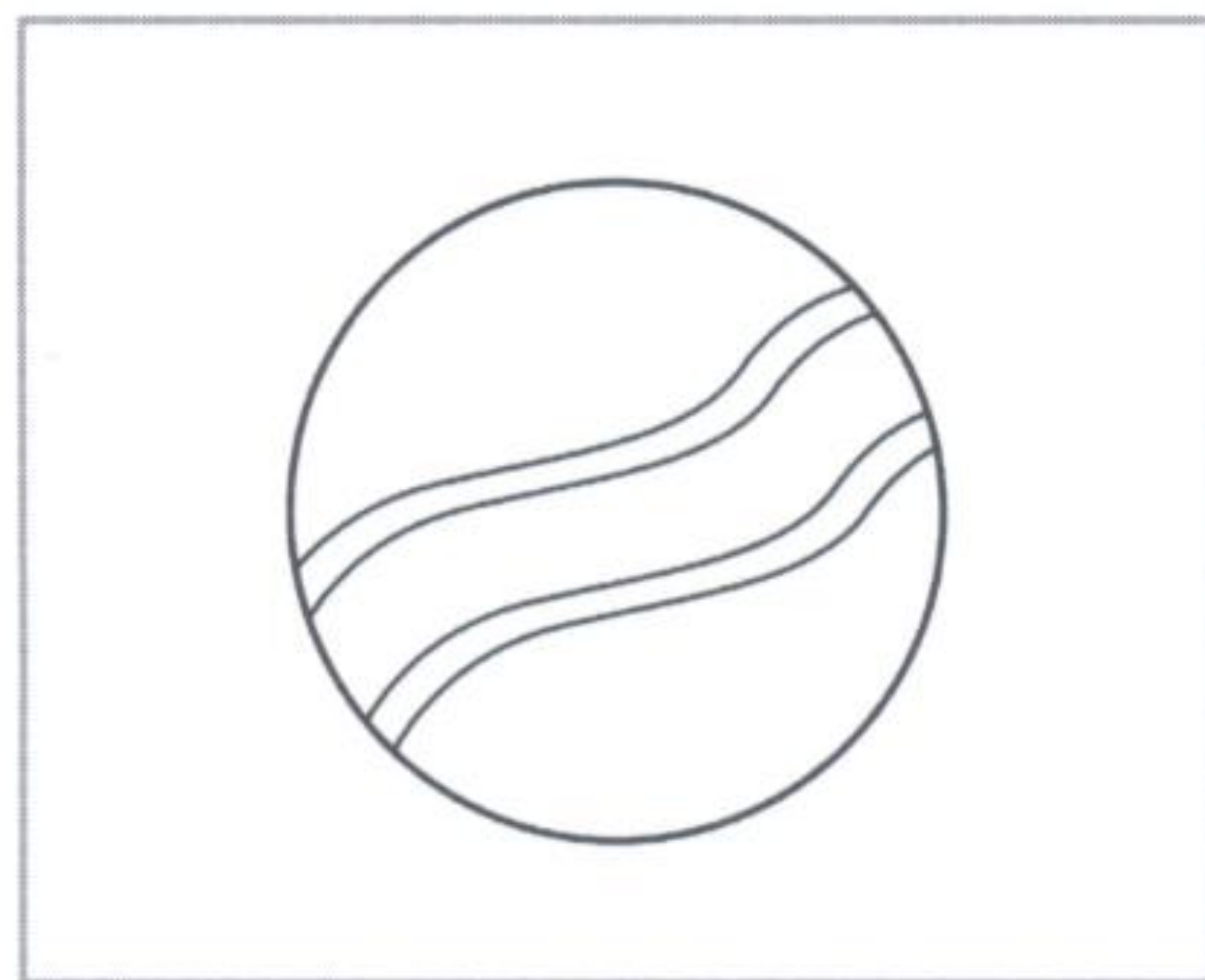
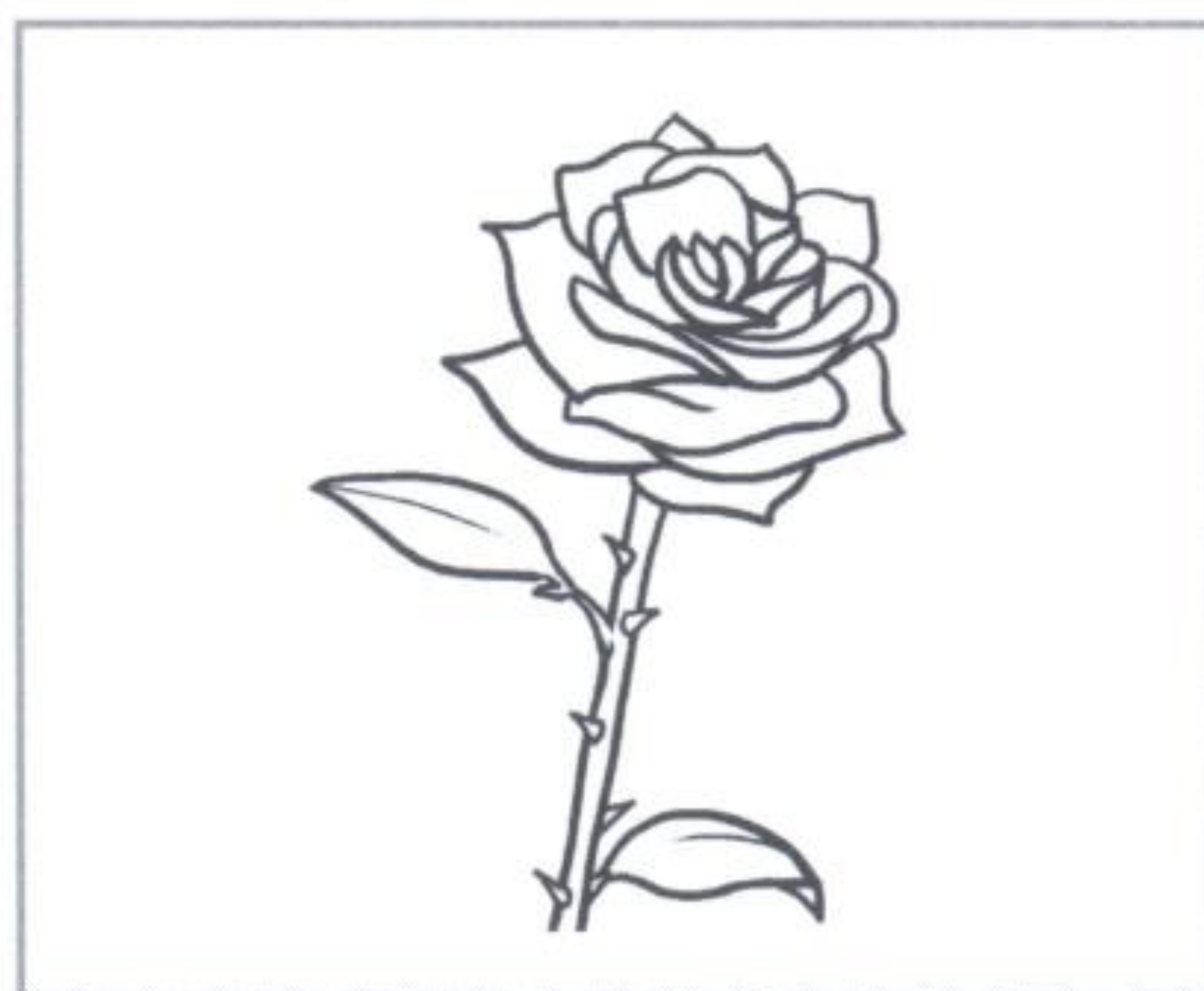
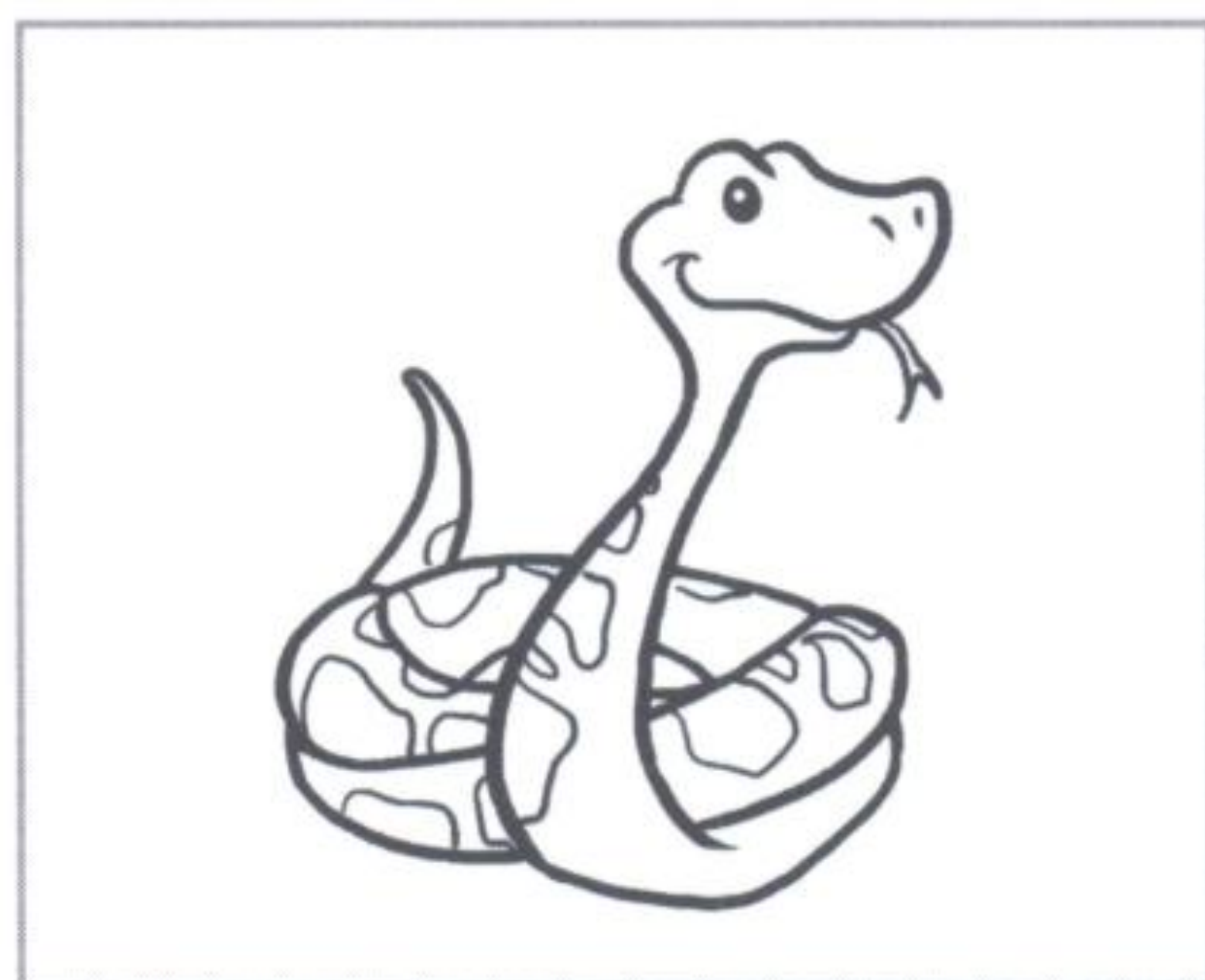
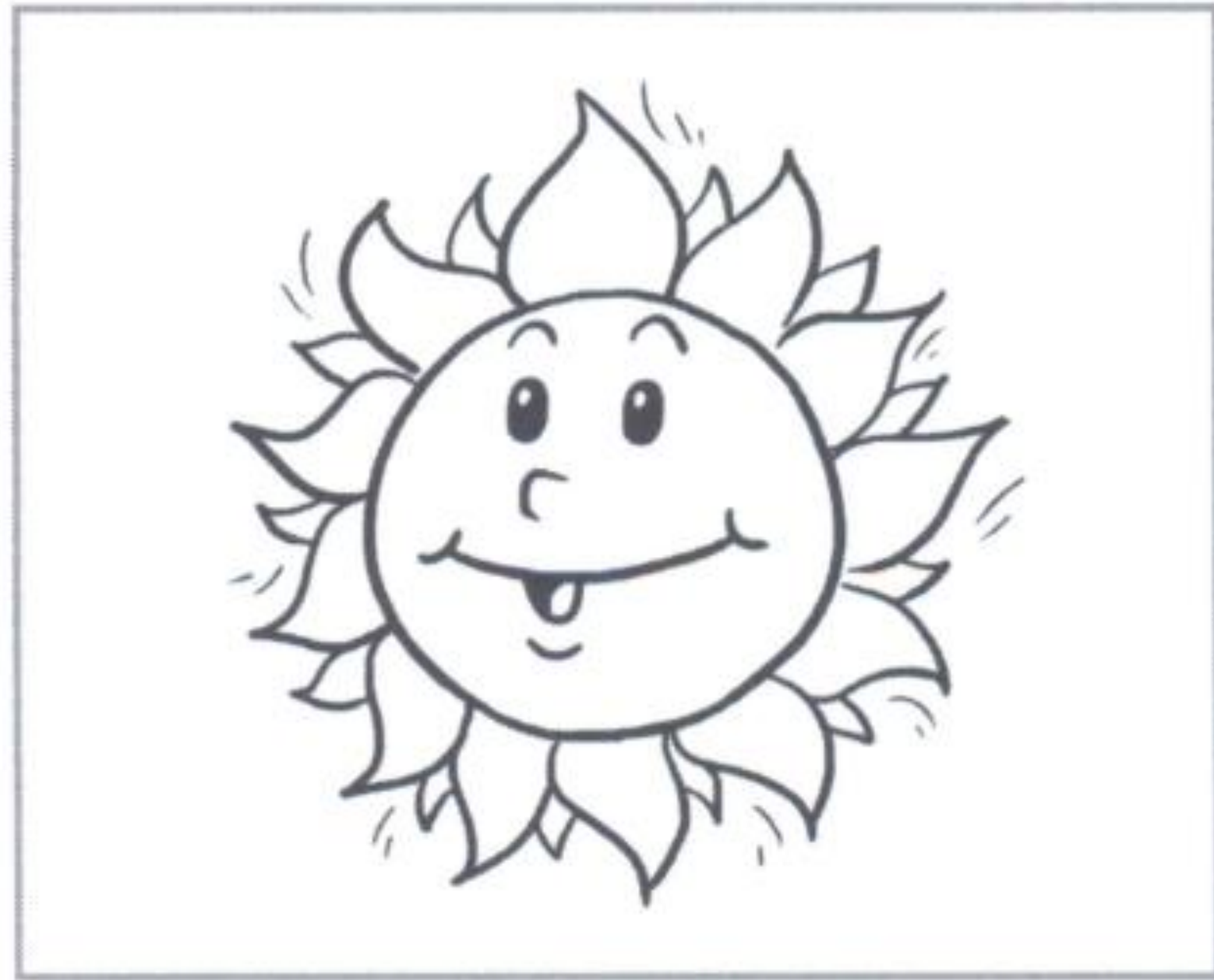

LENTA

VELOCE

LEGGERA

ROTONDA

LUNGO

CALDO

SPINOSA

COMODO

DOLCE





SCHEDA

119

SCRIVI SOTTO AD OGNI DISEGNO LA PAROLA CHE LO DESCRIVE MEGLIO, SCEGLIENDO TRA QUELLE QUI SOTTO

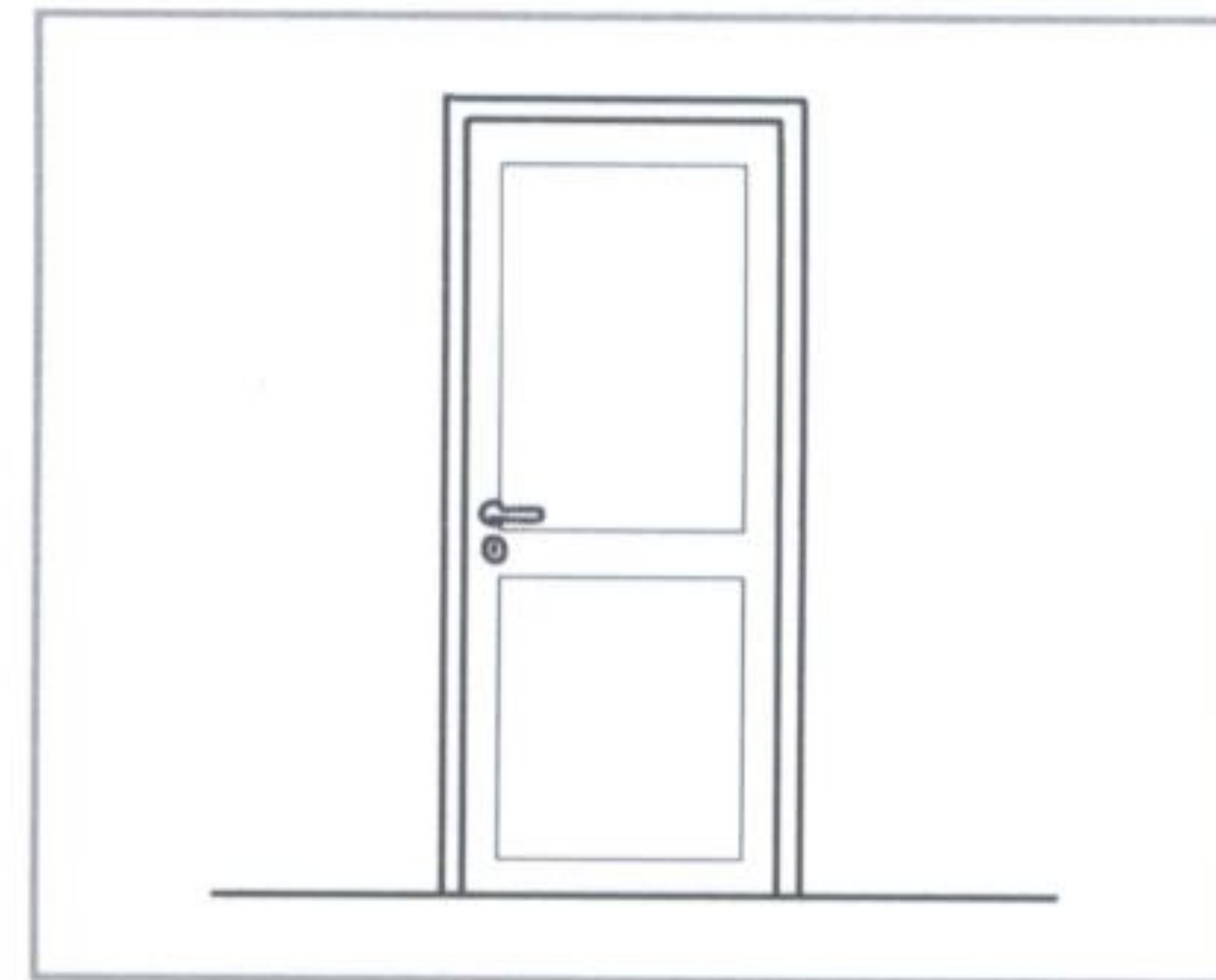
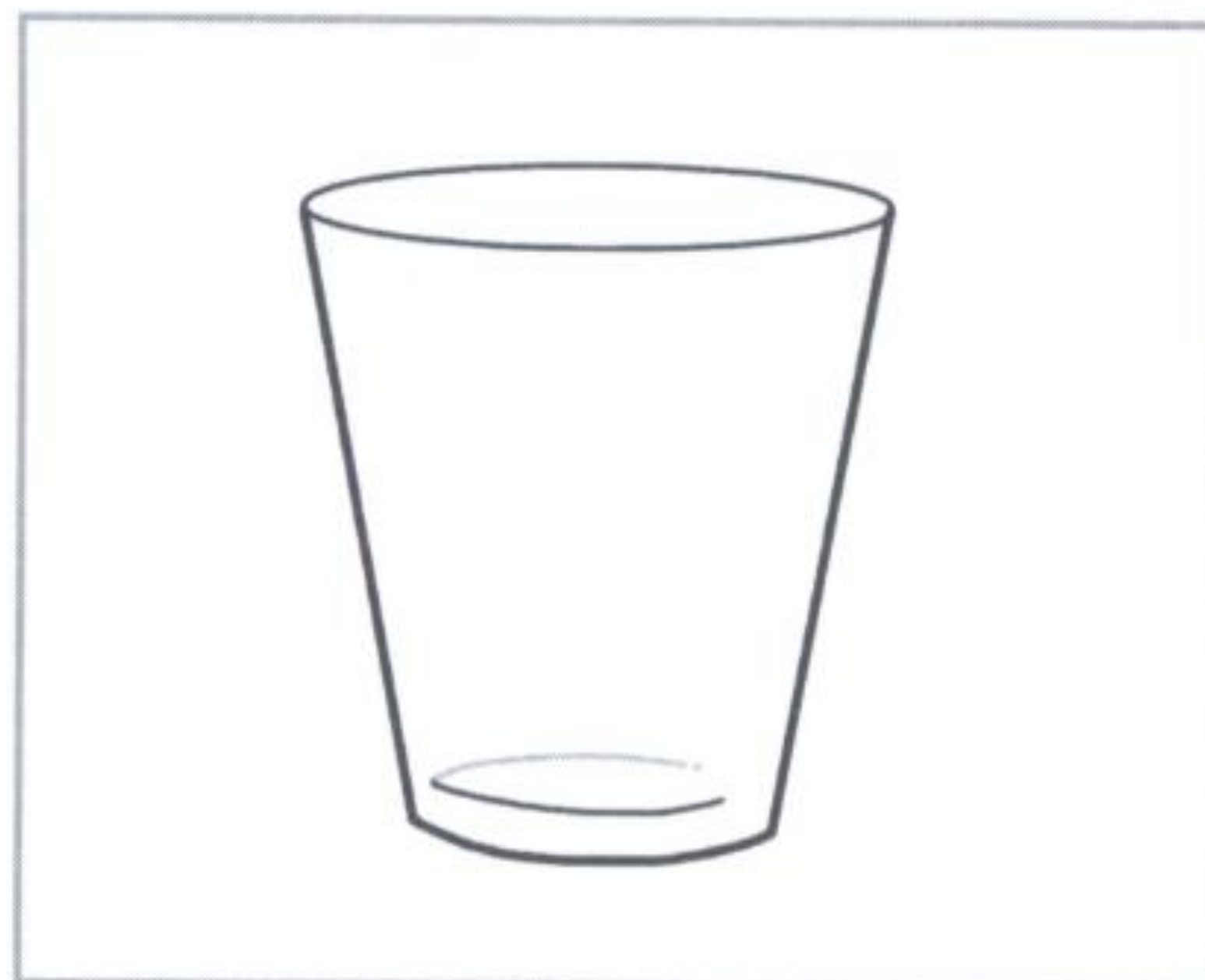
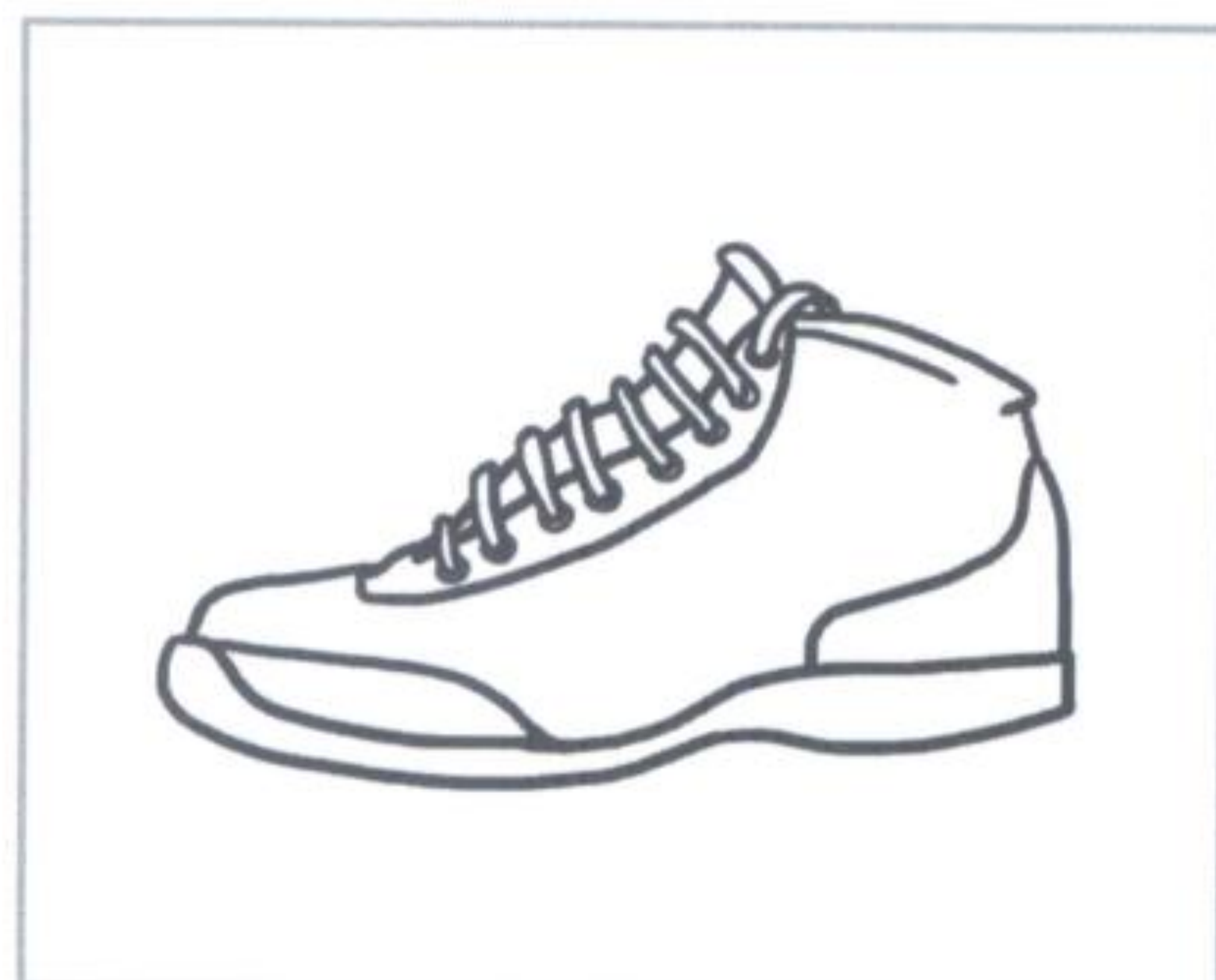
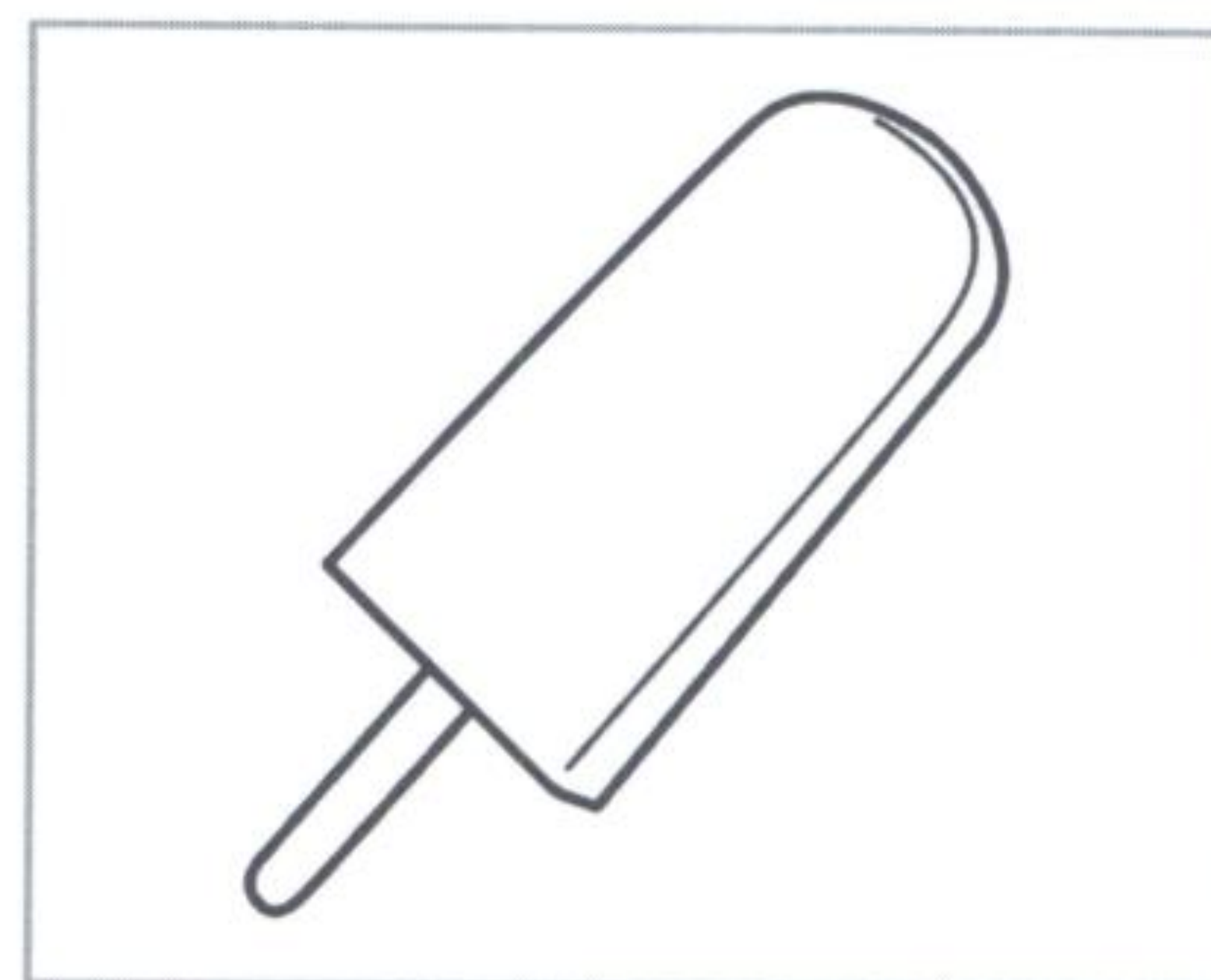
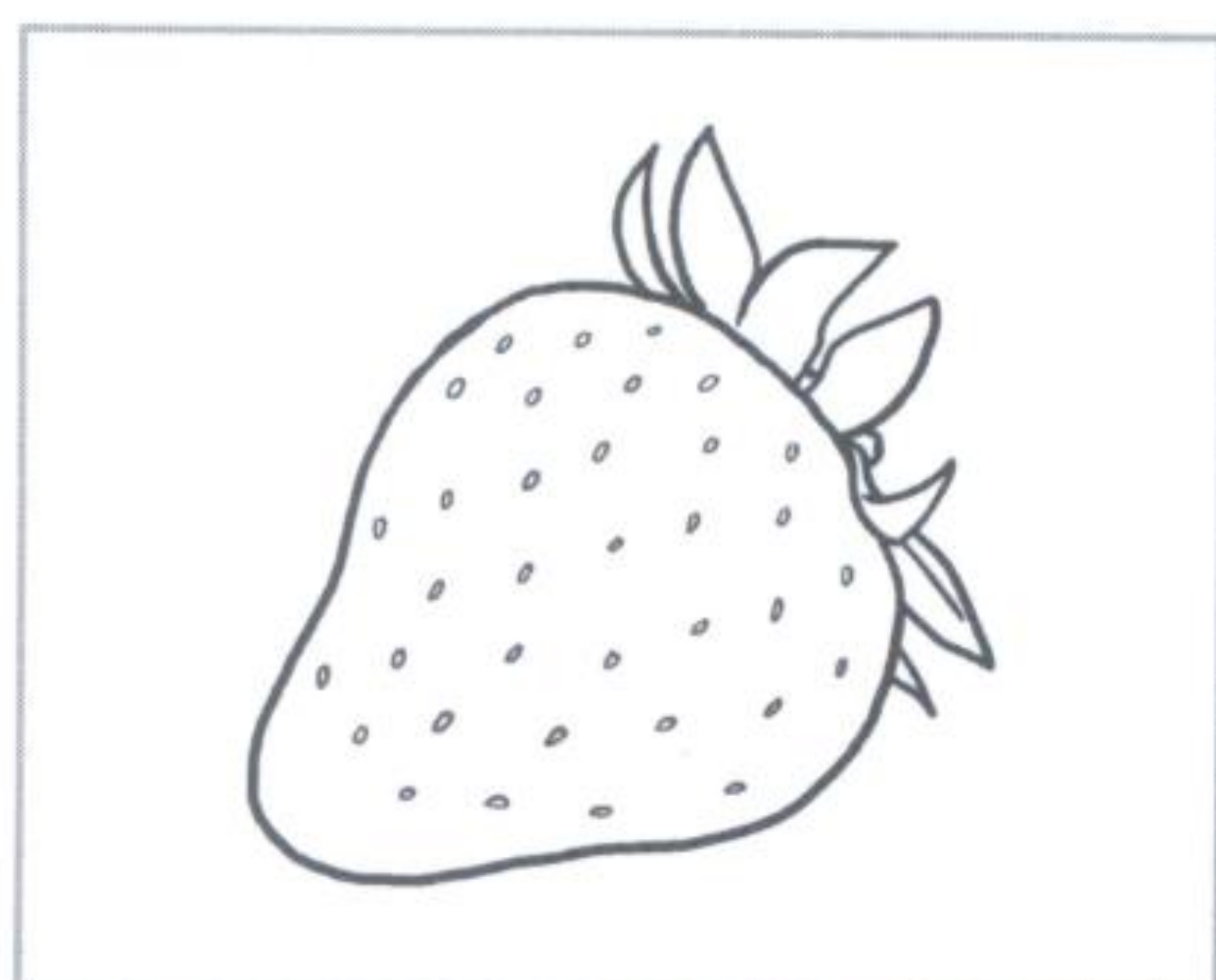
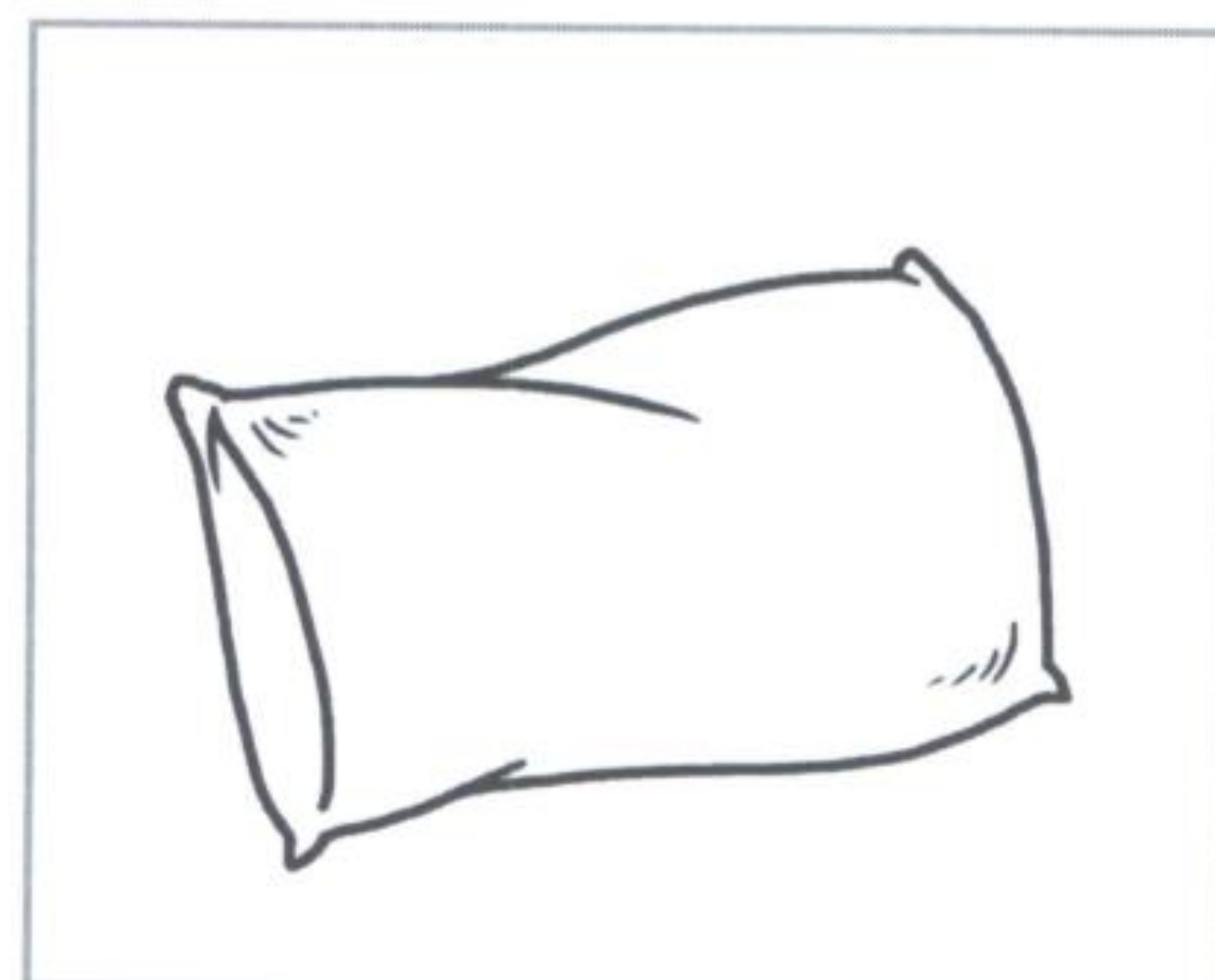
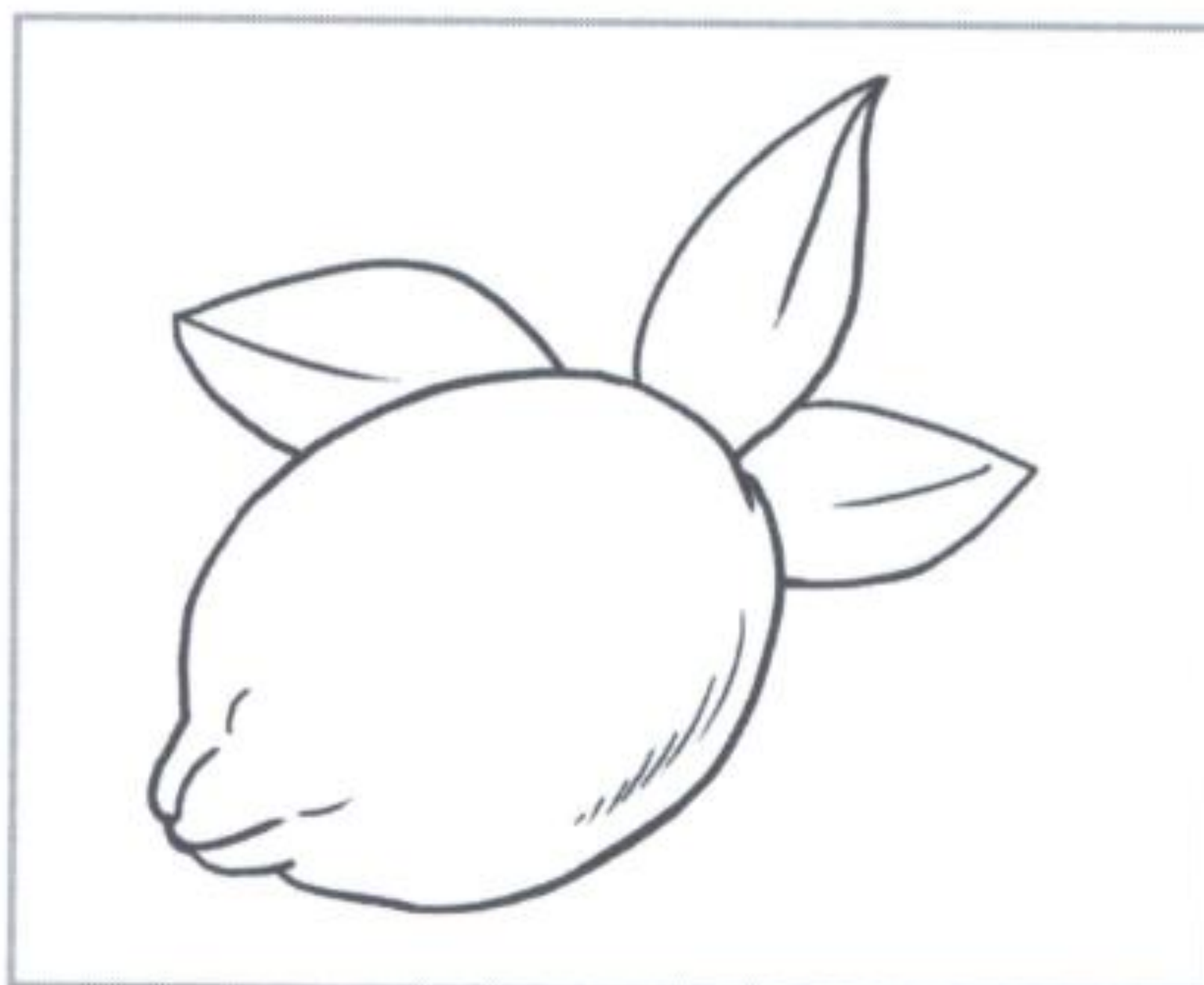

ALLACCIATA

CHIUSA

BRILLANTE

PROFUMATO

ROSSA

TRASPARENTE

ASPRO

MORBIDO

FREDDO



148



INSERISCI IN OGNI FRASE IL SOGGETTO  
SCEGLIENDOLO FRA QUELLI QUI SOTTO

SCHEDA  
120

1. La \_\_\_\_\_ rincorre i ladri
2. Il \_\_\_\_\_ cura i malati
3. L' \_\_\_\_\_ atterra sulla pista
4. Il \_\_\_\_\_ taglia i capelli
5. Il \_\_\_\_\_ semina il grano



parrucchiere



elicottero



contadino

dottore



polizia





1. Luca \_\_\_\_\_ sulla neve
2. I bambini \_\_\_\_\_ a calcio
3. L'erba \_\_\_\_\_ nel giardino
4. La candela \_\_\_\_\_ la stanza
5. La trottola \_\_\_\_\_ veloce



gira

giocano

scia

illumina

cresce





INSERISCI IN OGNI FRASE IL COMPLEMENTO  
SCEGLIENDOLO FRA QUELLI QUI SOTTO



1. Le farfalle volano sui \_\_\_\_\_
2. Il papà lava i \_\_\_\_\_
3. Il bebè dorme nella \_\_\_\_\_
4. La tigre vive nella \_\_\_\_\_
5. Il bidello suona la \_\_\_\_\_



campanella



fiori

giungla



culla

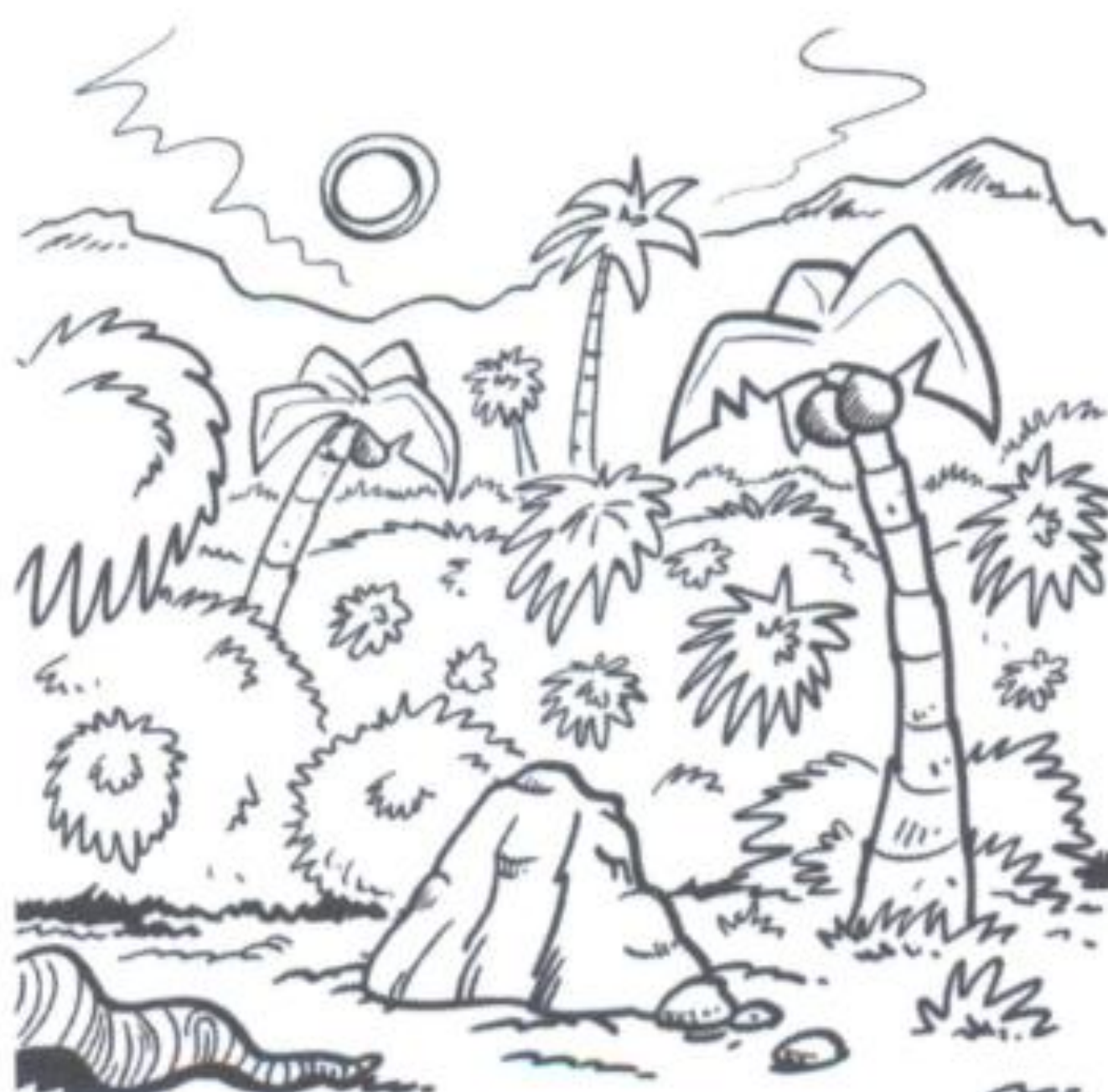

piatti







1. Giacomo mangia una \_\_\_\_\_ rossa
2. Christian va in gita con il \_\_\_\_\_
3. La mamma \_\_\_\_\_ la cena per i suoi bambini
4. Il cavallo \_\_\_\_\_
5. Simona gioca con la \_\_\_\_\_
6. Il \_\_\_\_\_ corre sui binari
7. I \_\_\_\_\_ portano Luca al parco
8. Il \_\_\_\_\_ si mette in testa
9. Manuela e Diego \_\_\_\_\_ le scale
10. Pamela \_\_\_\_\_ in piscina

mela

pulmino

cappello

bambola

treno

galoppa

nuota

prepara

nonni

salgono



INSERISCI NELLE FRASI LA CONGIUNZIONE «E»  
O IL VERBO ESSERE «È»



**E**

1. Luca \_\_\_\_\_ Marco sono amici
2. Il papà \_\_\_\_\_ la mamma vanno al cinema
3. Il cane \_\_\_\_\_ il gatto sono animali domestici
4. Sul tavolo ci sono due mele \_\_\_\_\_ due pere
5. Michela ha mangiato la pasta \_\_\_\_\_ la verdura

**È**

1. Stefano \_\_\_\_\_ un bravo papà
2. Il cane \_\_\_\_\_ un animale fedele
3. La frutta che ho comprato \_\_\_\_\_ molto buona
4. La mamma \_\_\_\_\_ stanca
5. Giulia \_\_\_\_\_ la migliore amica di Martina





## E OPPURE È?

1. Francesco \_\_\_\_\_ caduto \_\_\_\_\_ piange
2. Il gelato \_\_\_\_\_ buono \_\_\_\_\_ fresco
3. Quando Sara \_\_\_\_\_ felice canta \_\_\_\_\_ balla tutto il giorno
4. Anna mangia un panino \_\_\_\_\_ un gelato perché \_\_\_\_\_ affamata
5. Oggi \_\_\_\_\_ brutto tempo: tira vento \_\_\_\_\_ piove!
6. Elena \_\_\_\_\_ Matteo festeggiano: oggi \_\_\_\_\_ il loro compleanno
7. Cristina \_\_\_\_\_ una sarta: taglia \_\_\_\_\_ cuce i vestiti
8. La pizza con il prosciutto \_\_\_\_\_ formaggio \_\_\_\_\_ squisita
9. Lo sport preferito da Roberta \_\_\_\_\_ Alessandro \_\_\_\_\_ il tennis
10. Mio padre \_\_\_\_\_ un contadino: coltiva frutta \_\_\_\_\_ verdura



INSERISCI NELLE FRASI LA PREPOSIZIONE «A» O IL VERBO AVERE «HA»



**A**

1. La sera vado \_\_\_\_\_ letto molto presto
2. Tutti i bambini vanno \_\_\_\_\_ scuola
3. Oggi Luisa va \_\_\_\_\_ trovare i suoi nonni
4. Ho prestato l'album delle figurine \_\_\_\_\_ Serena
5. Andiamo \_\_\_\_\_ spasso?

**HA**

1. Valentina \_\_\_\_\_ tanto sonno
2. La ballerina \_\_\_\_\_ comprato un nuovo tutù
3. Il bebè piange perché \_\_\_\_\_ tanta fame
4. Cappuccetto rosso \_\_\_\_\_ incontrato il lupo nel bosco
5. Lorenzo \_\_\_\_\_ mangiato tante caramelle





## A OPPURE HA?

1. Mia zia \_\_\_\_\_ mangiato \_\_\_\_\_ casa mia
2. Gabriele \_\_\_\_\_ portato lo zaino \_\_\_\_\_ scuola
3. \_\_\_\_\_ che ora vanno \_\_\_\_\_ letto i bambini?
4. \_\_\_\_\_ Federica piace andare \_\_\_\_\_ cavallo
5. Paolo \_\_\_\_\_ regalato un fiore \_\_\_\_\_ Beatrice
6. Il mio papà va \_\_\_\_\_ correre tutti i giorni nel parco
7. Alessio \_\_\_\_\_ spedito una cartolina \_\_\_\_\_ Massimiliano
8. \_\_\_\_\_ carnevale Manuel si è mascherato da Zorro
9. Anna \_\_\_\_\_ accompagnato Simona \_\_\_\_\_ casa
10. Christian \_\_\_\_\_ portato il cane \_\_\_\_\_ spasso