

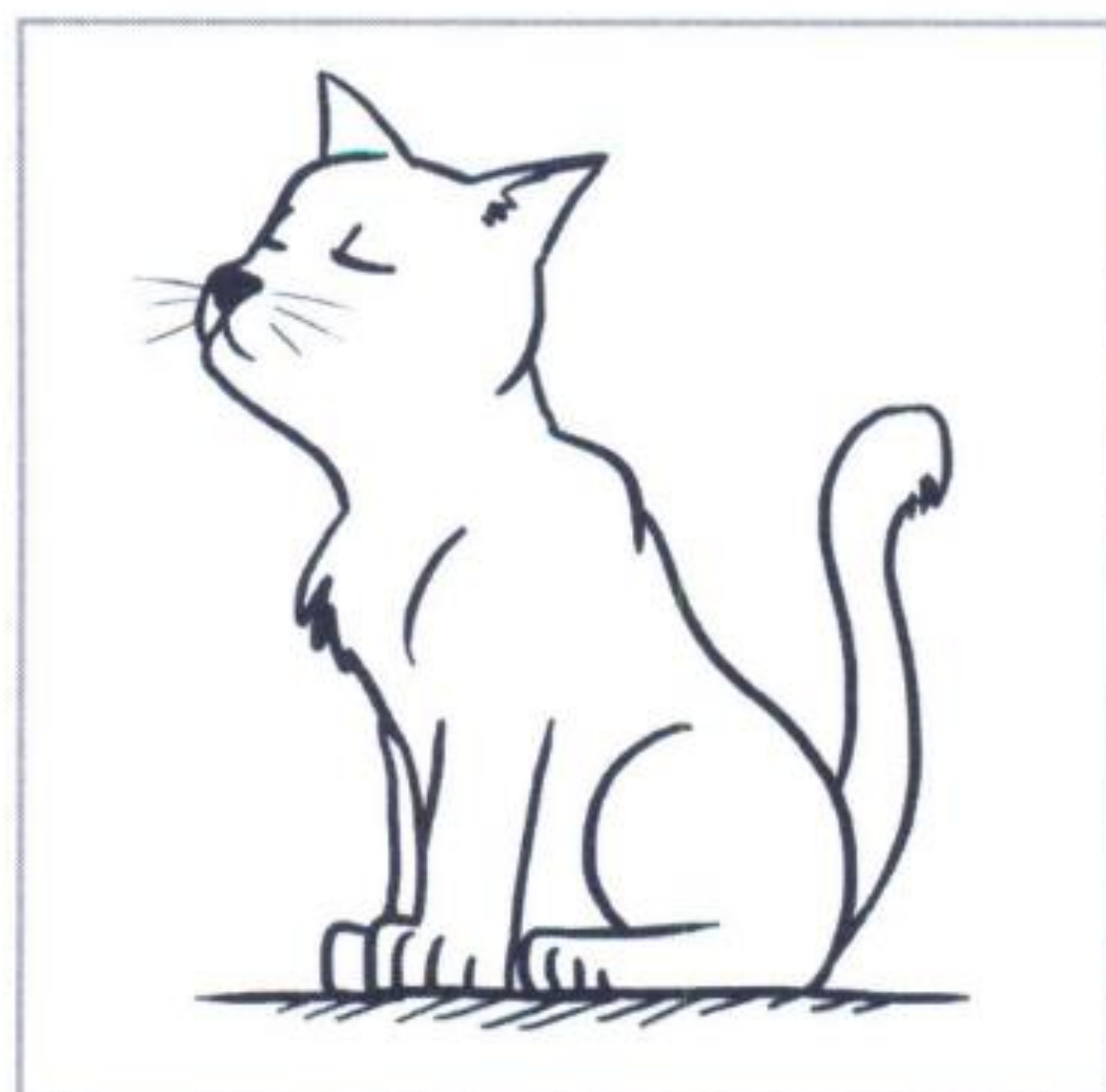

CHE VERSO FA?

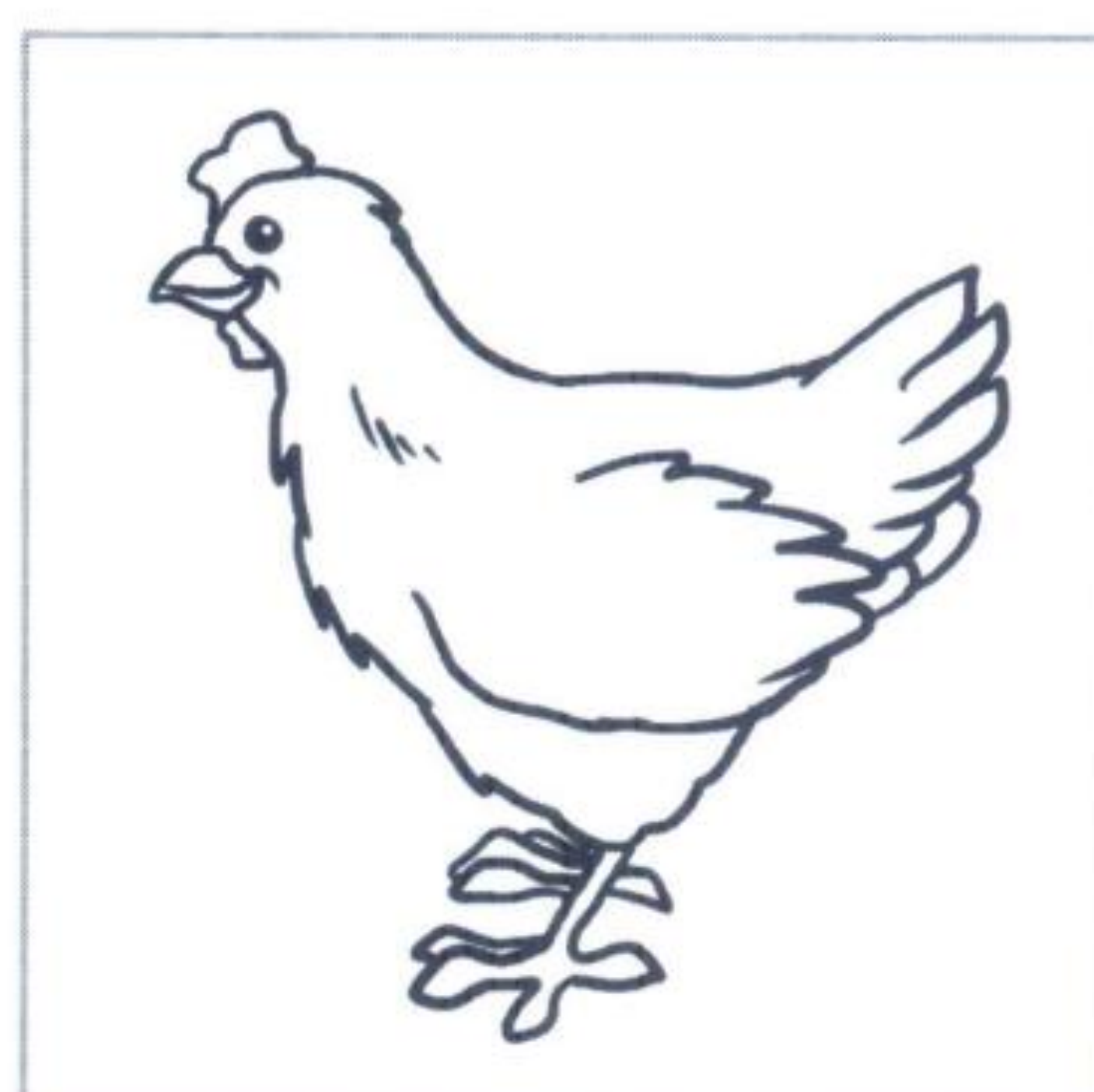

MIAO

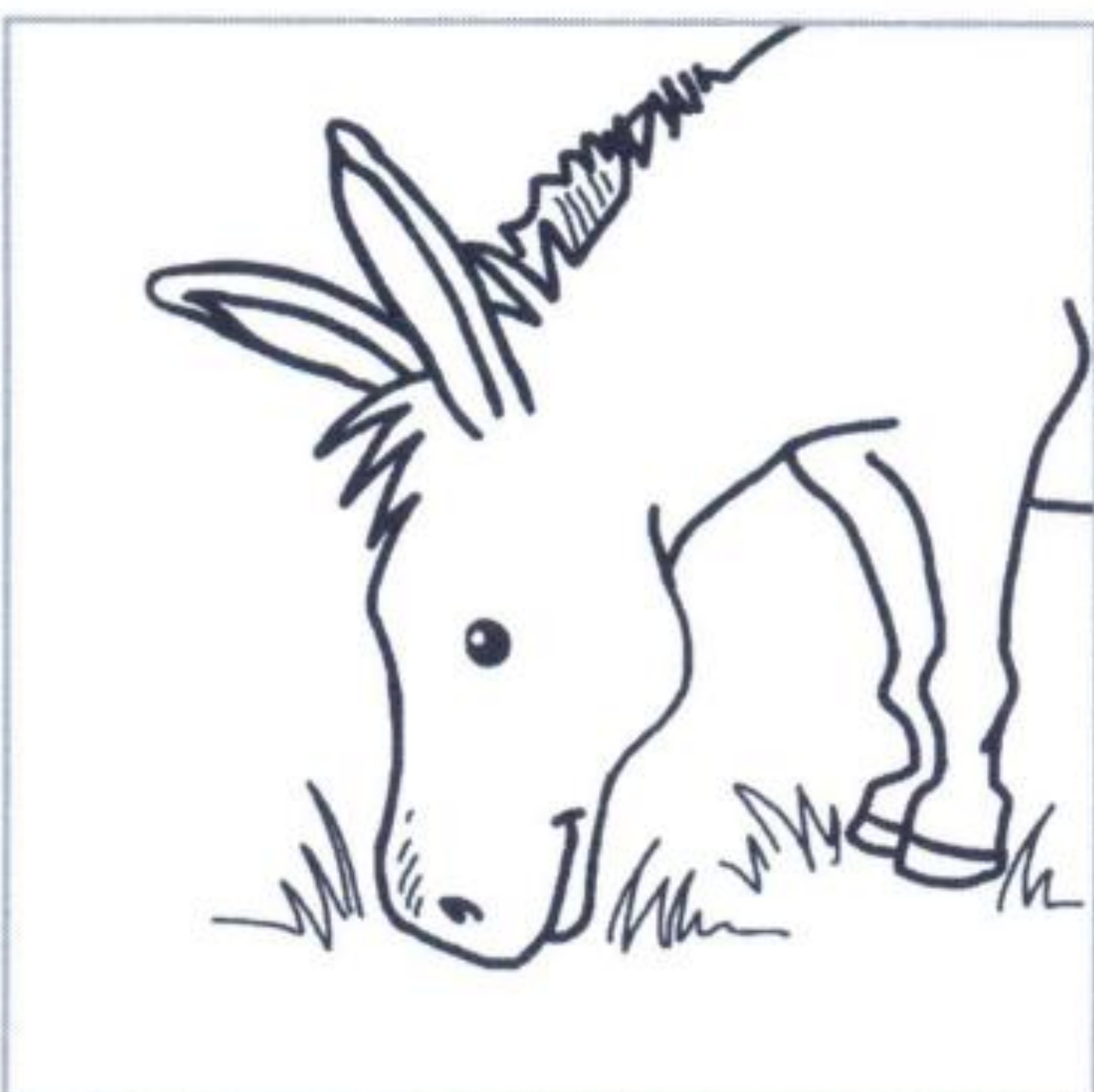
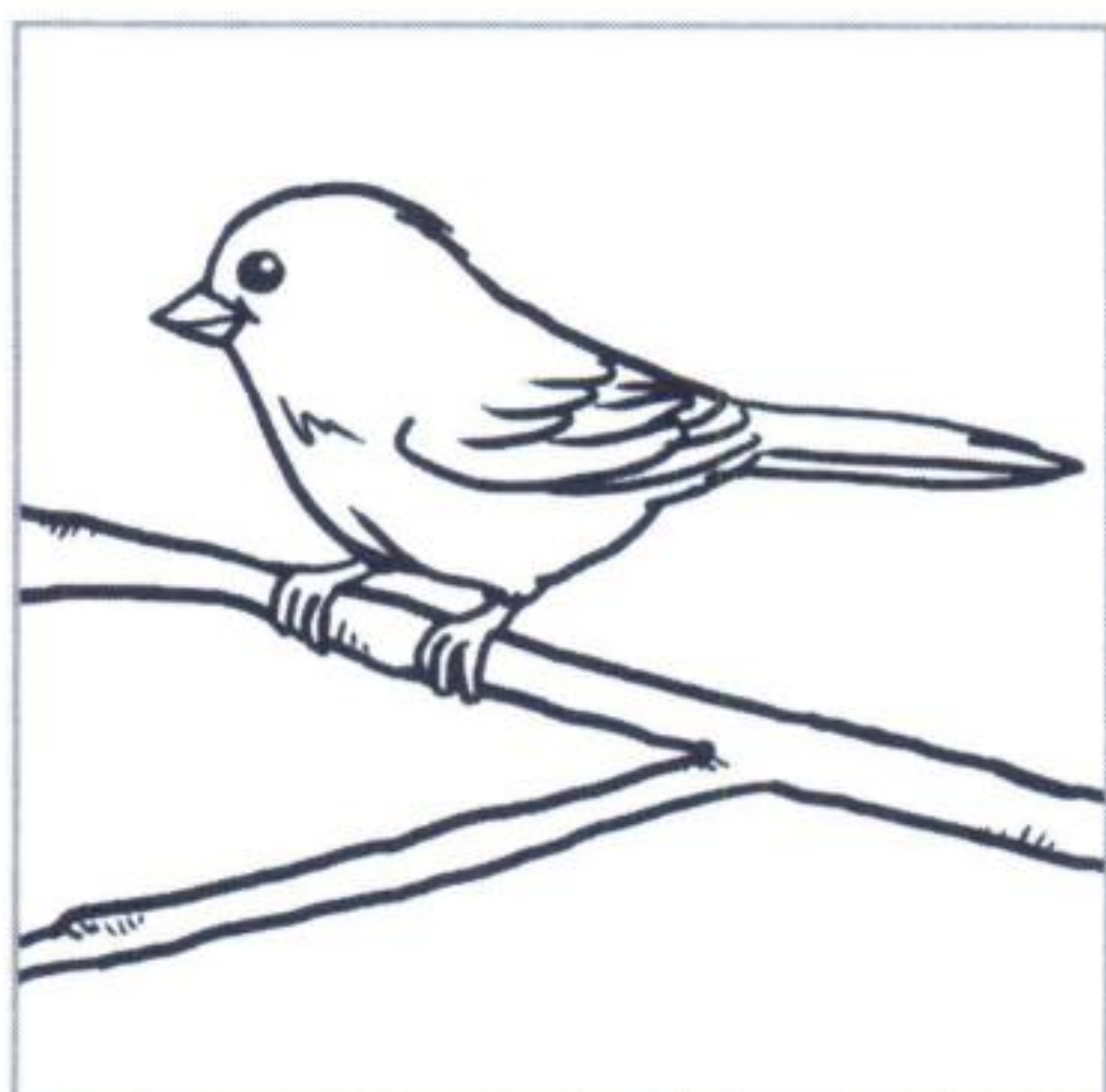
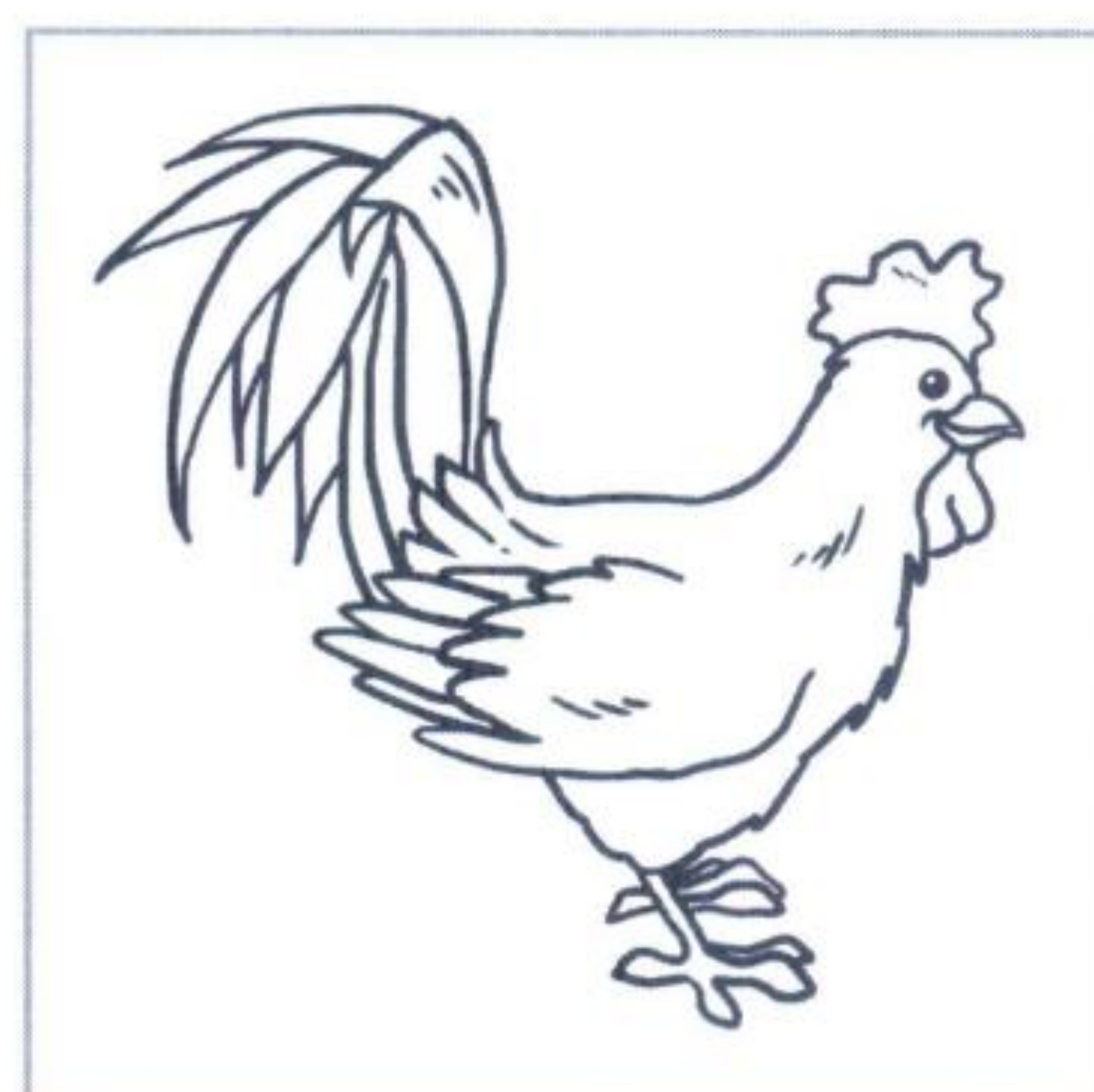
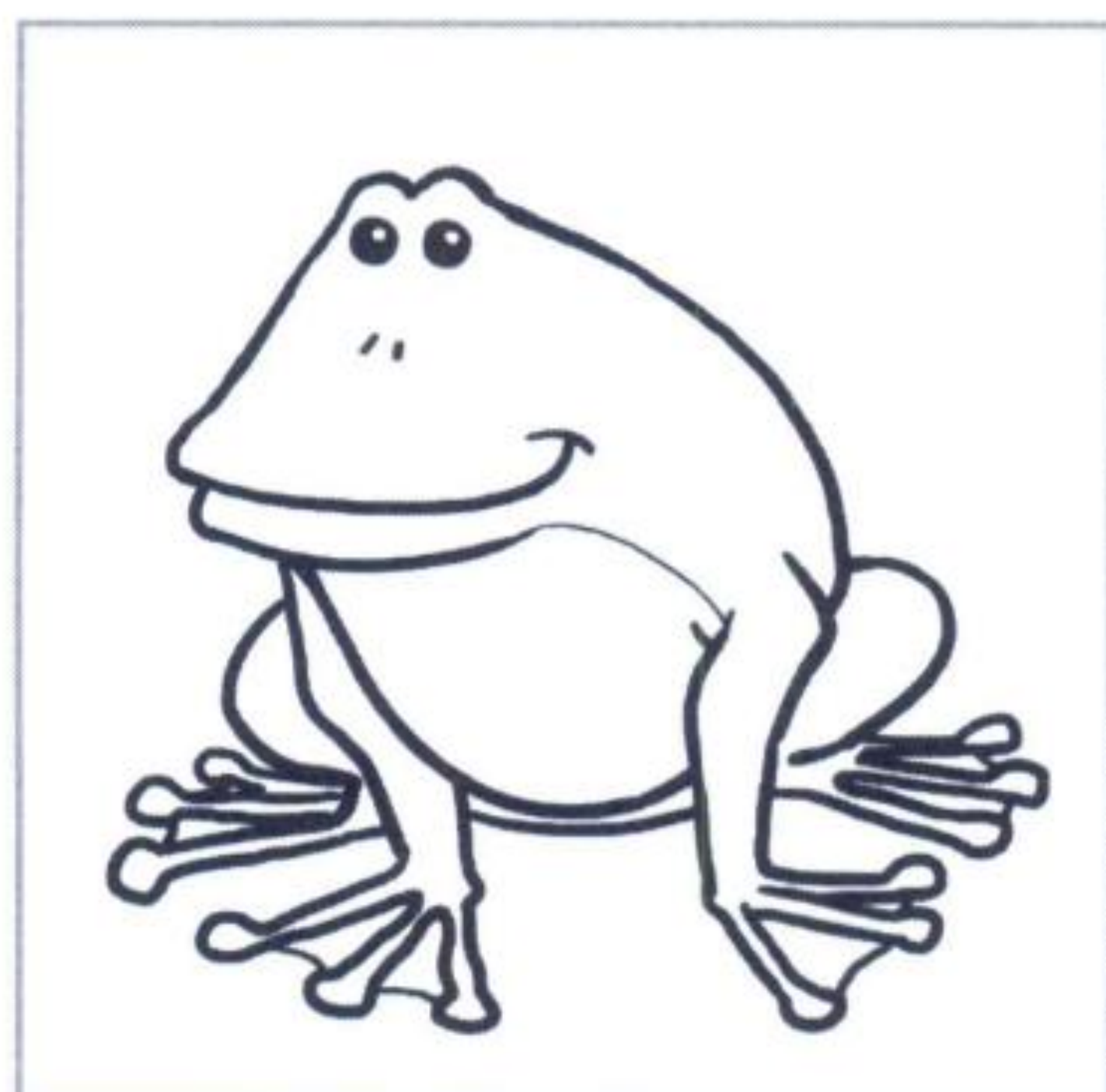
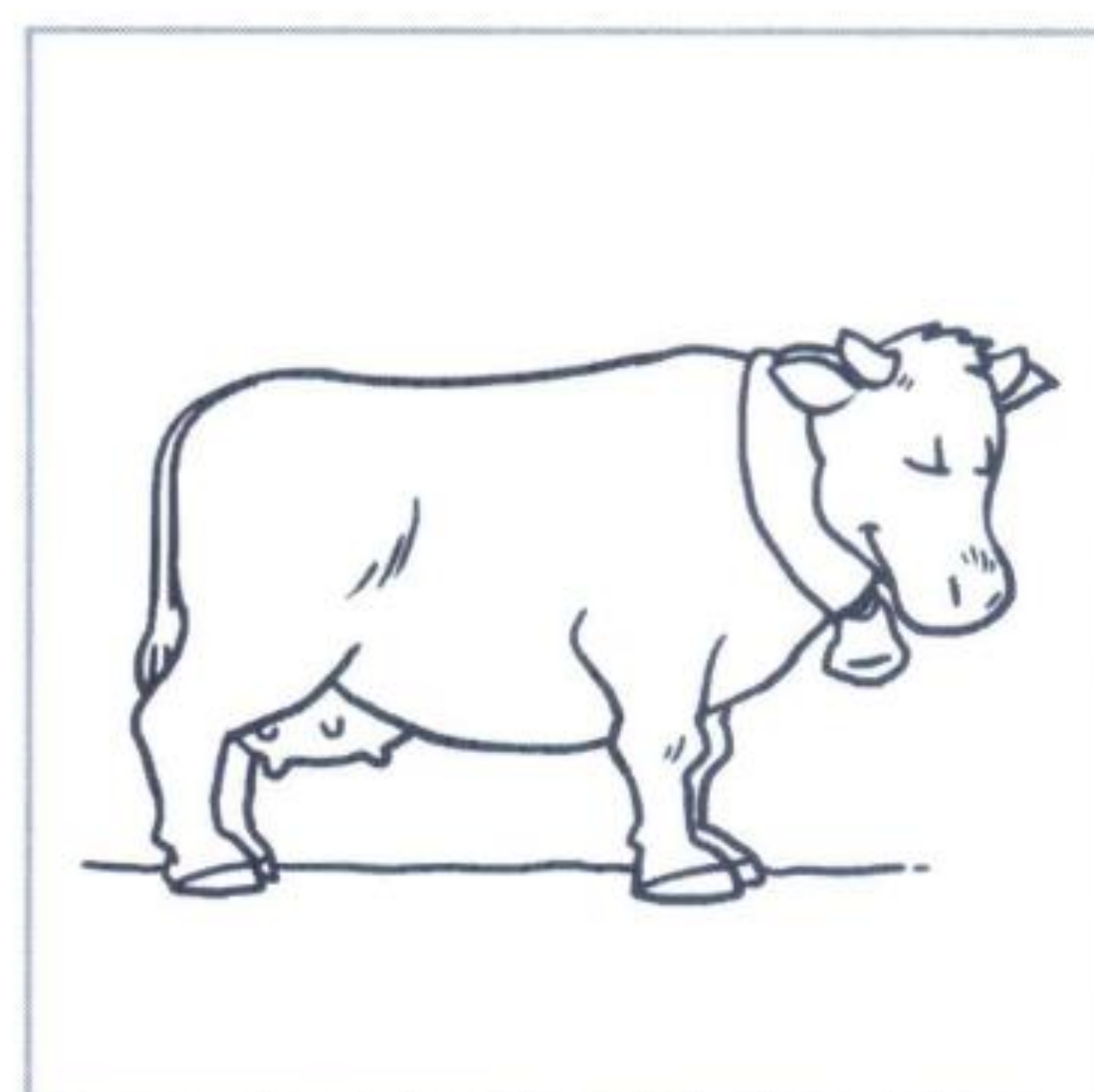
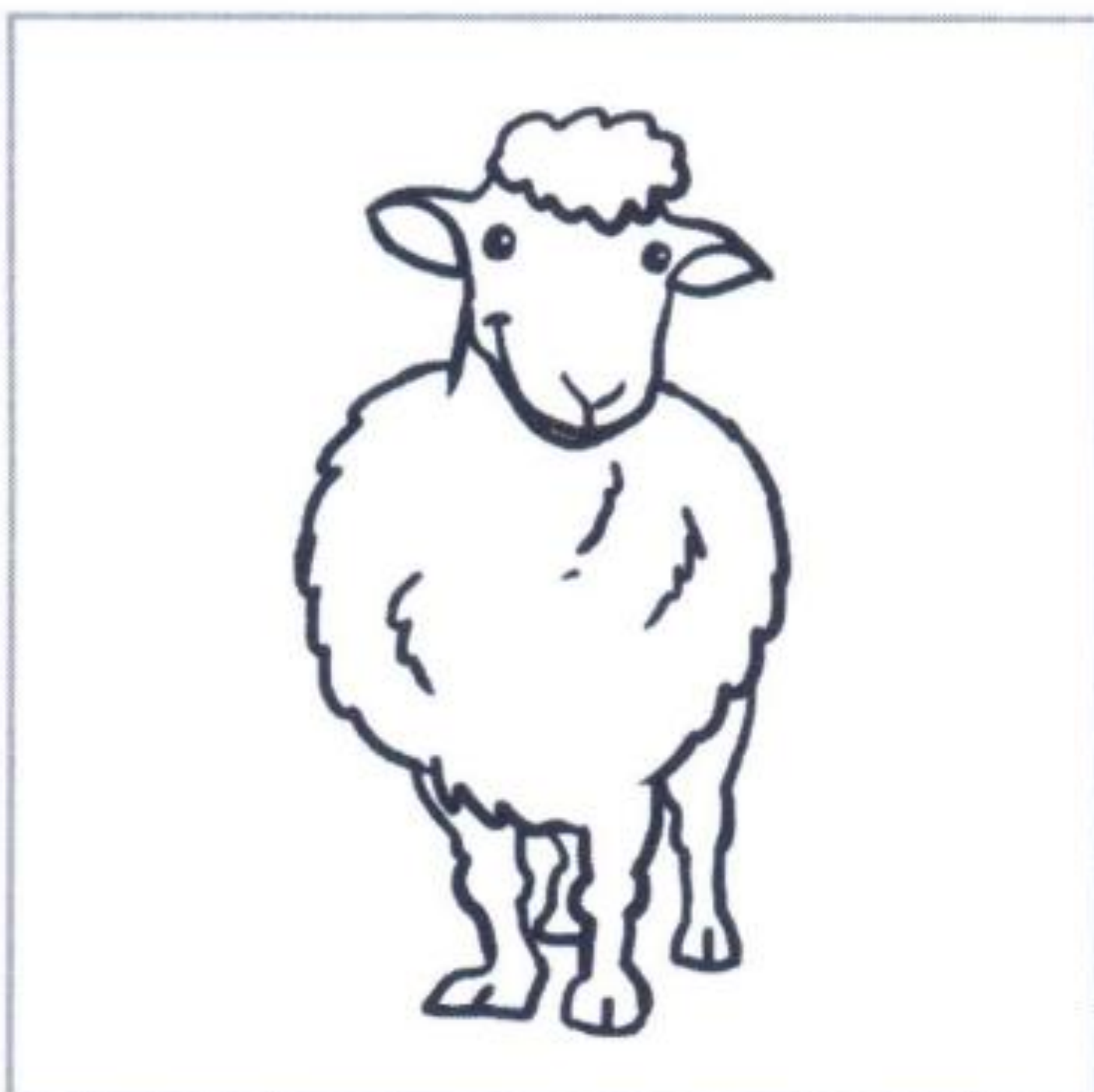

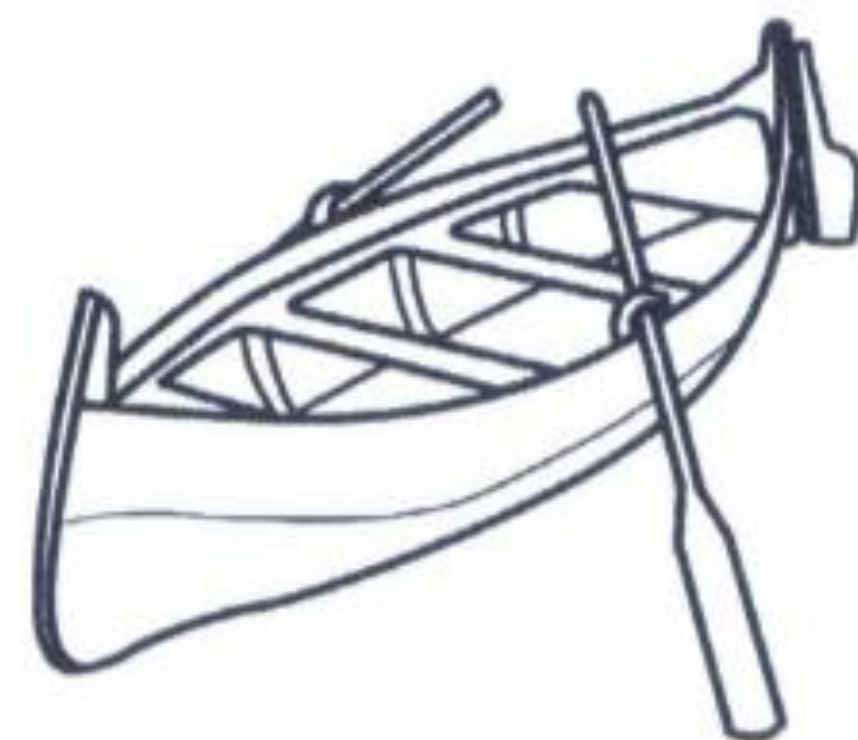
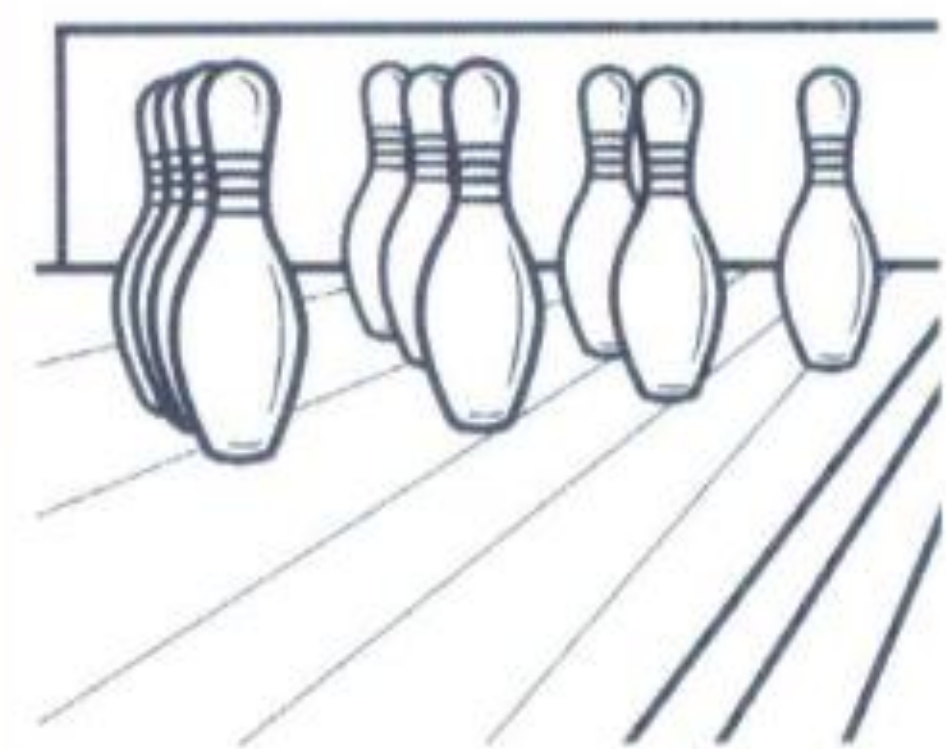

BA

BE

BI

BO

BU

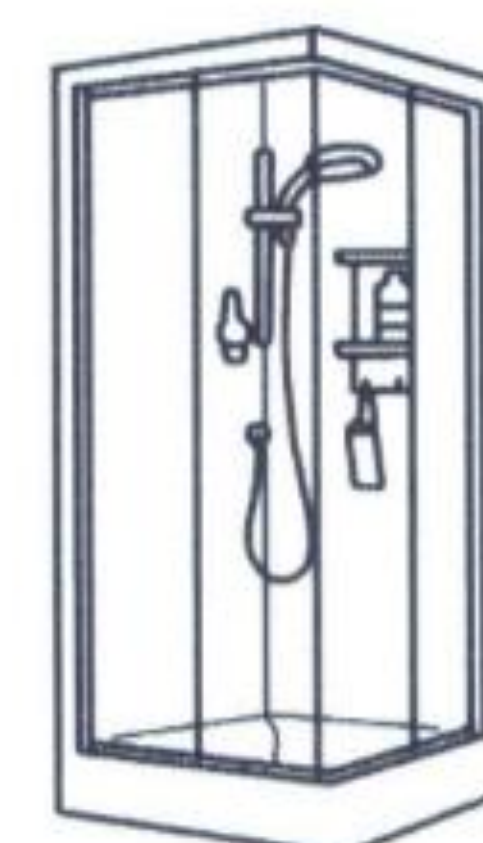
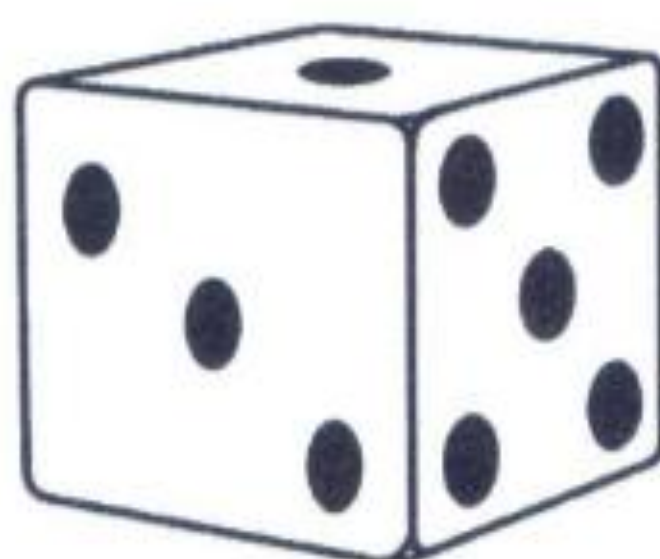
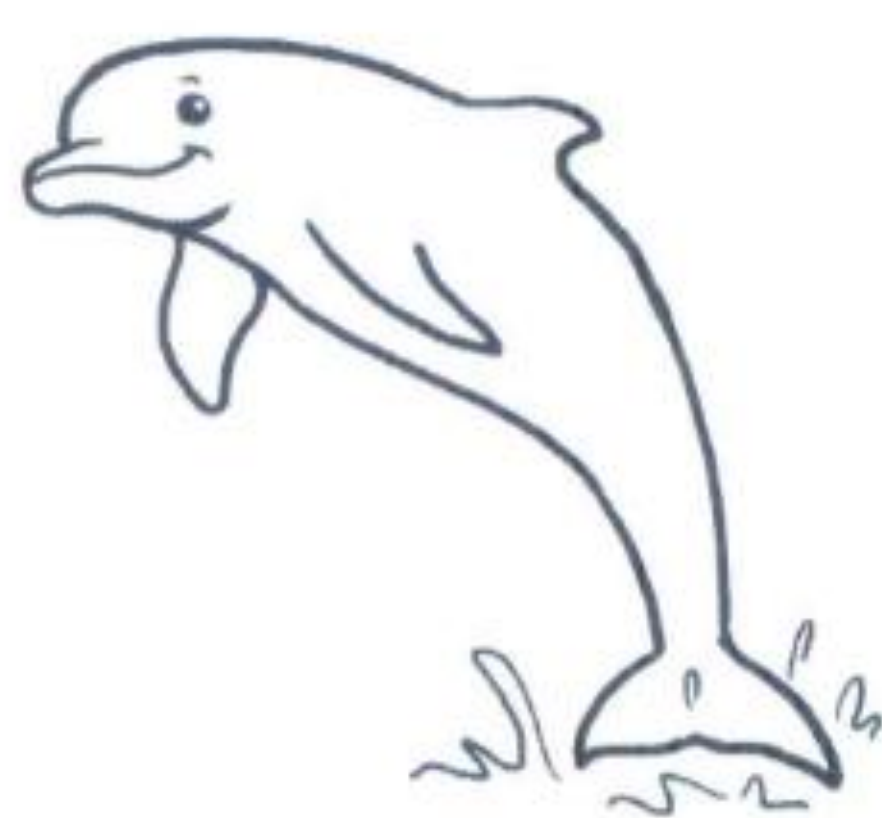

DA

DE

DI

DO

DU

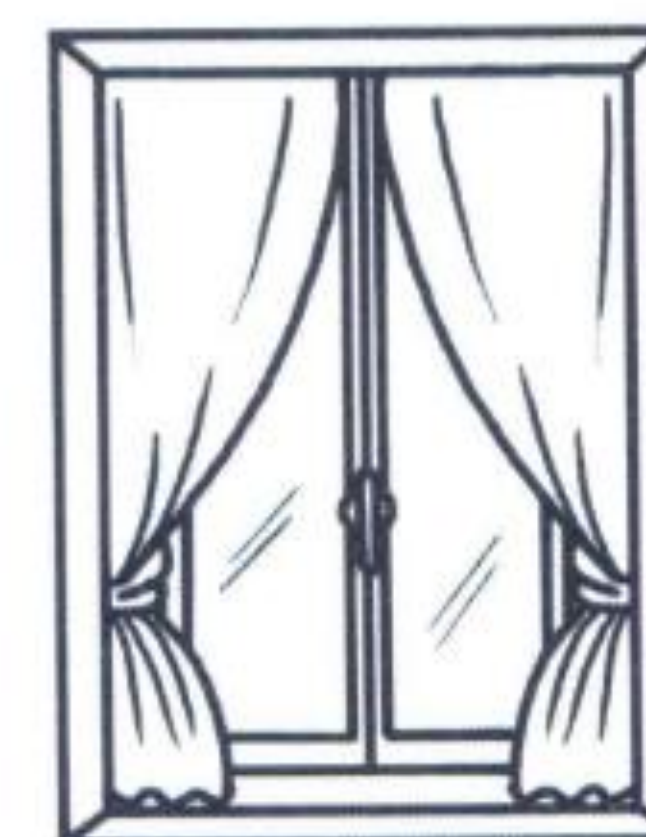
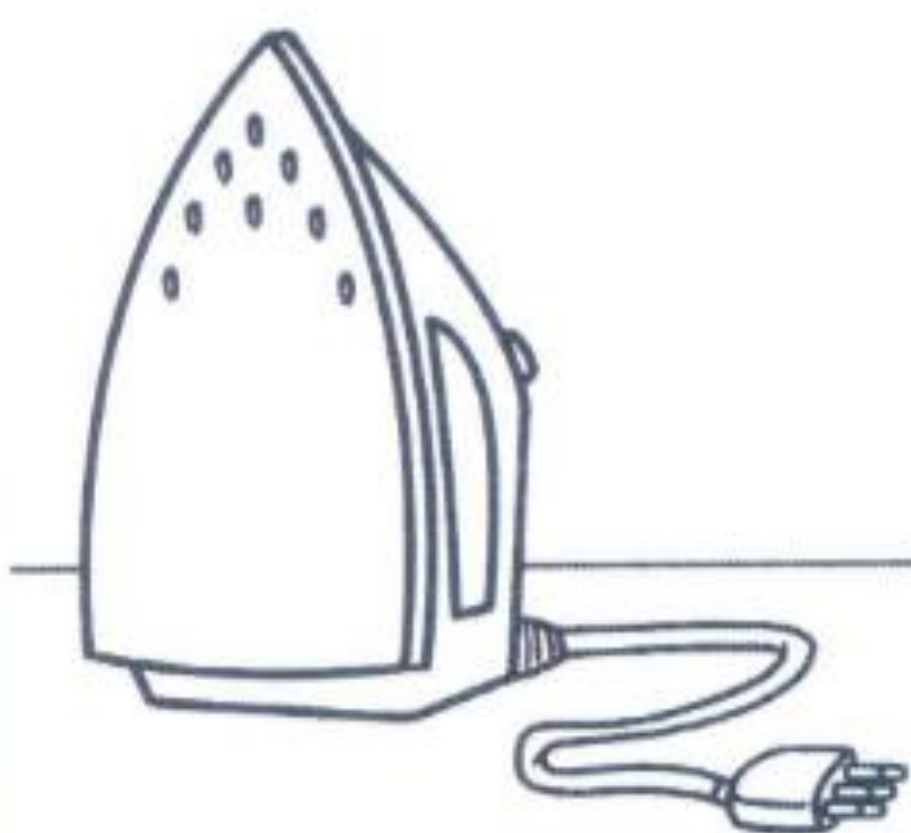

FA

FE

FI

FO

FU



COLLEGA OGNI DISEGNO ALLE LETTERE INIZIALI
CHE NE COMPONGONO IL NOME

SCHEDA
55



LA

LE

LI

LO

LU

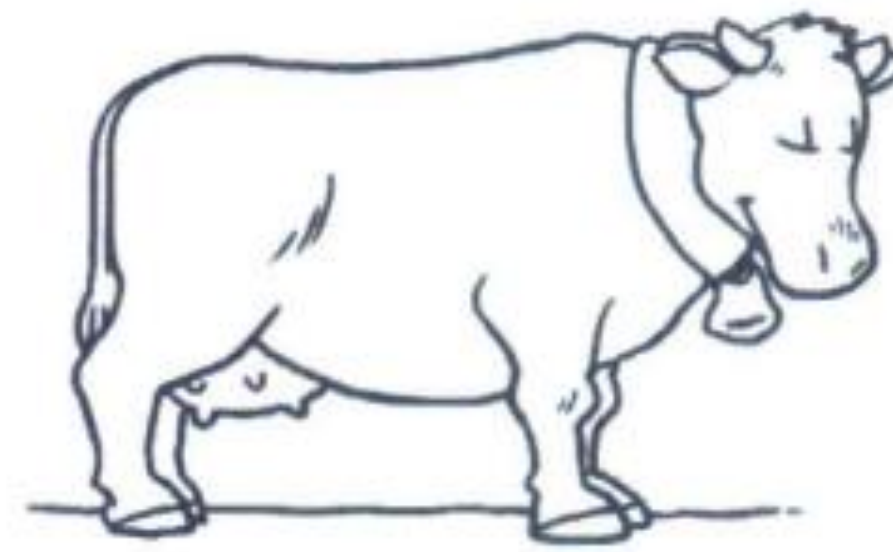

MA

ME

MI

MO

MU



NA

NE

NI

NO

NU

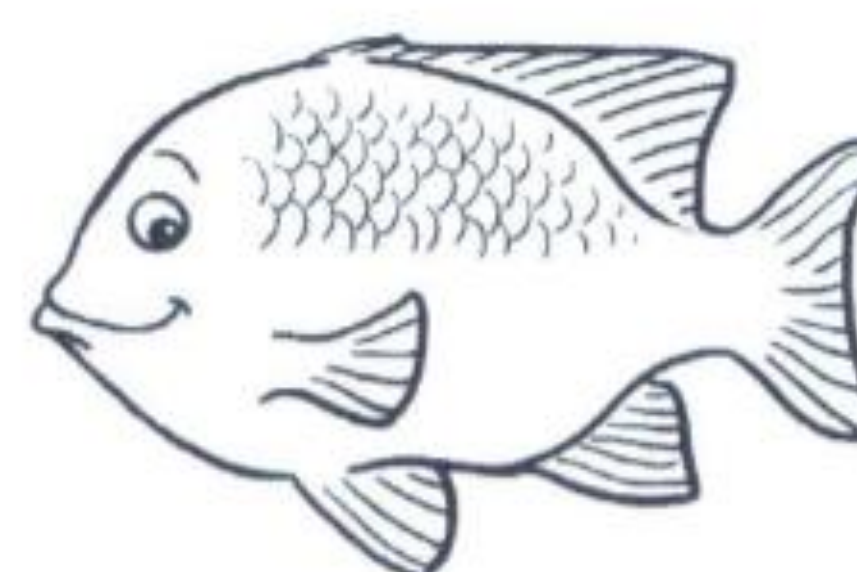
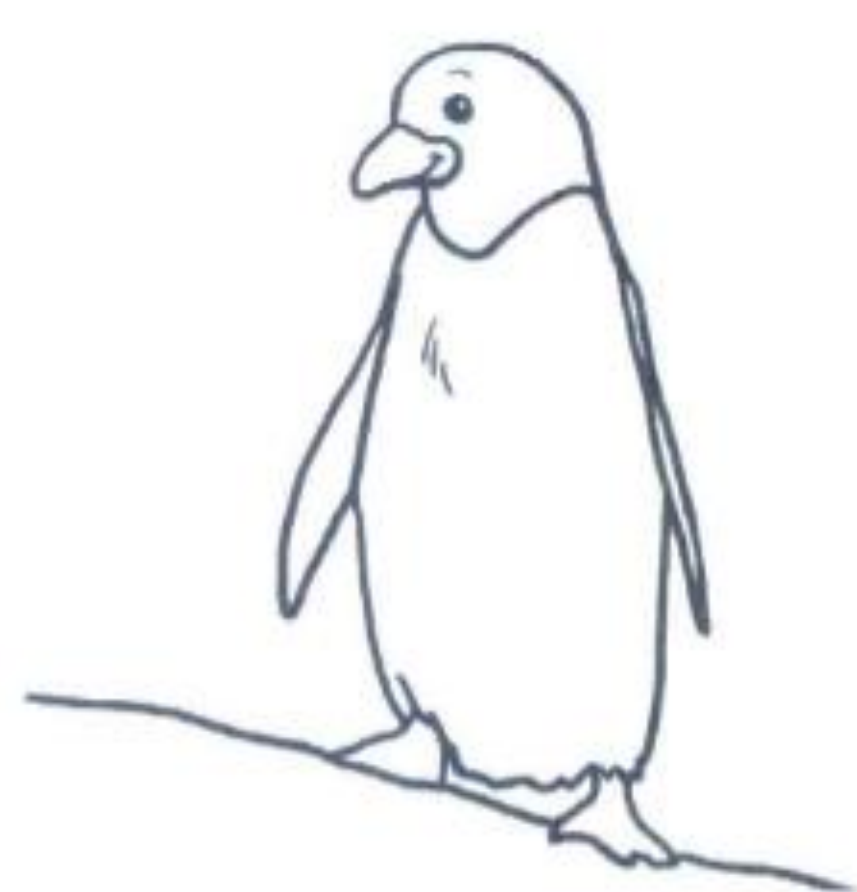

PA

PE

PI

PO

PU

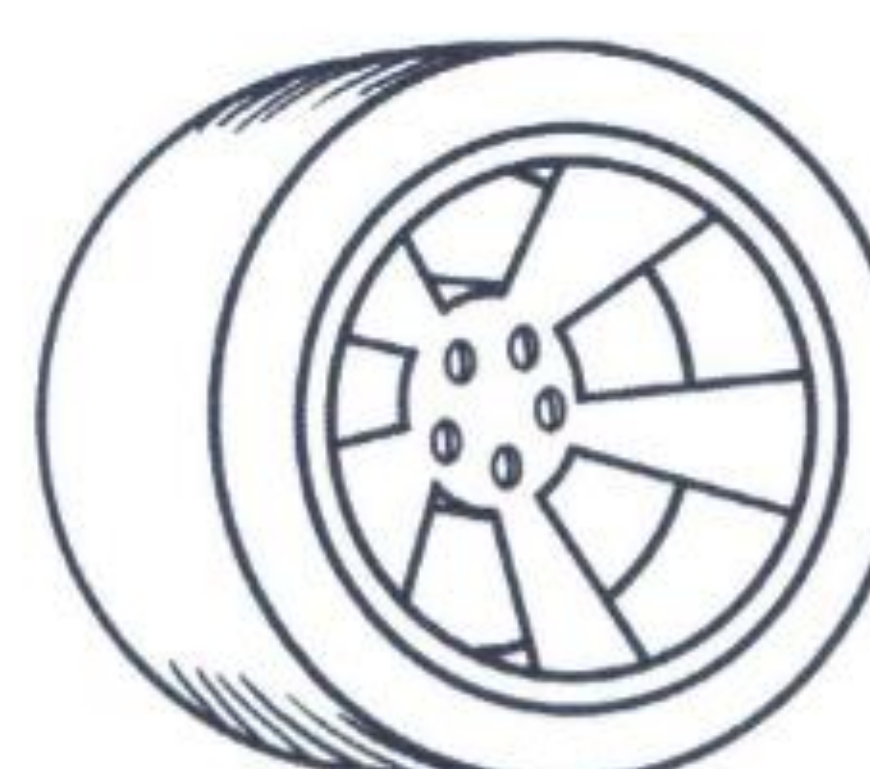
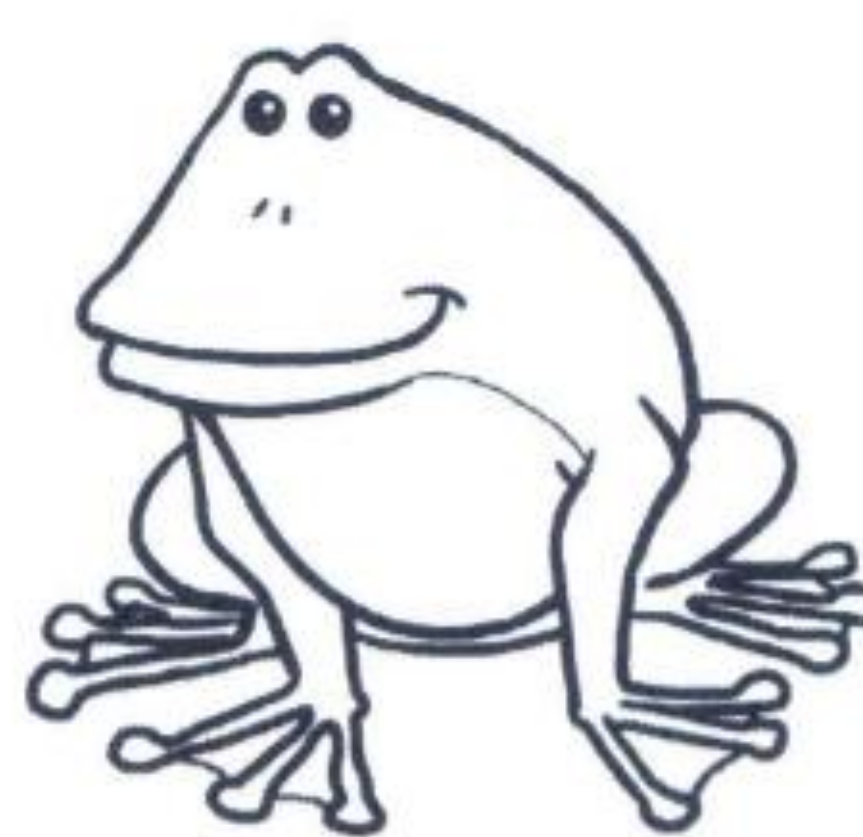
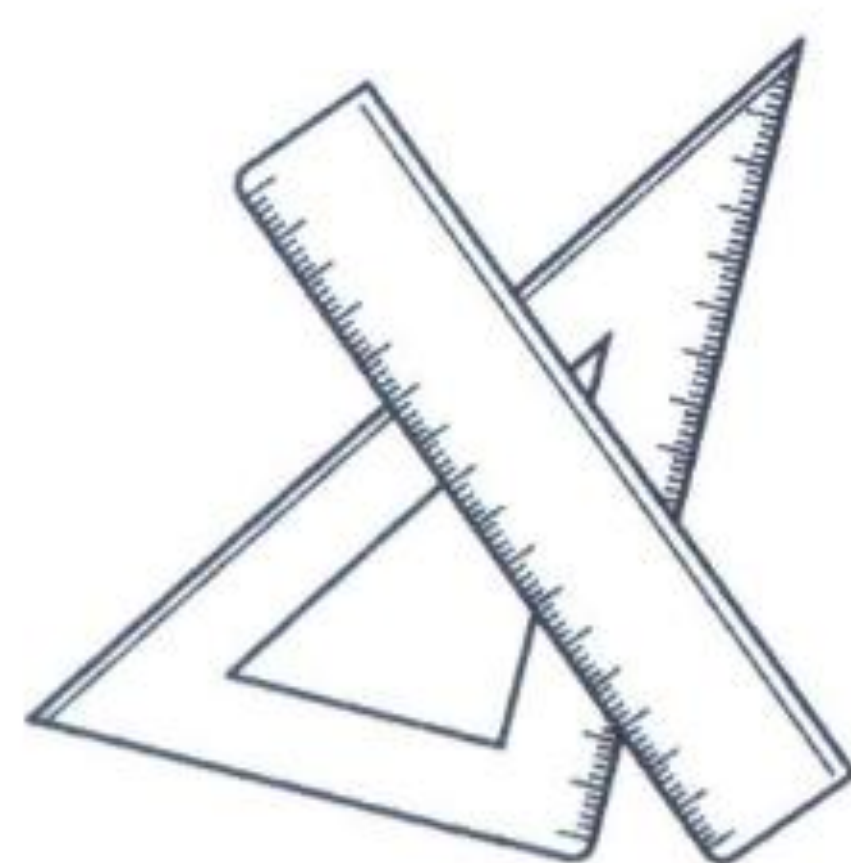
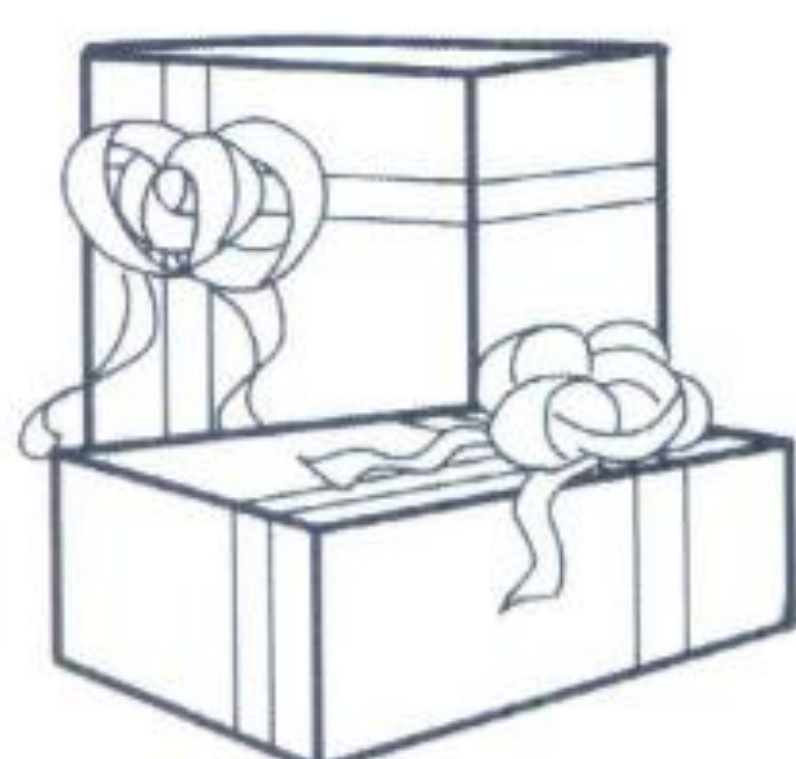

RA

RE

RI

RO

RU

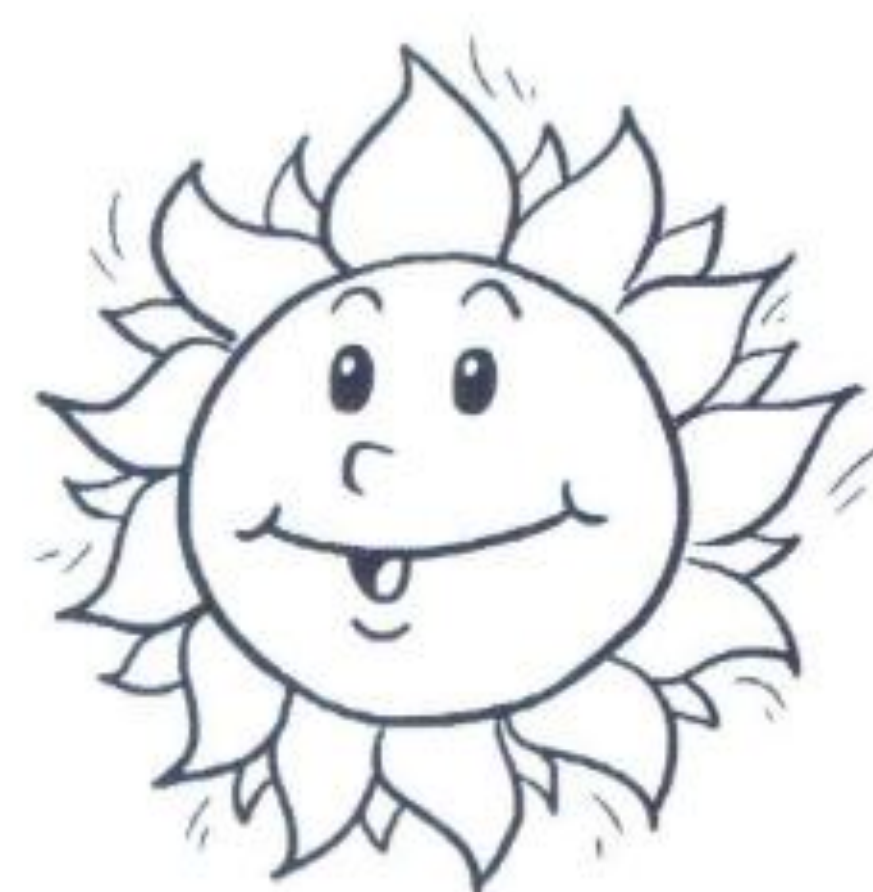

SA

SE

SI

SO

SU



COLLEGA OGNI DISEGNO ALLE LETTERE INIZIALI
CHE NE COMPONGONO IL NOME

SCHEDA

57

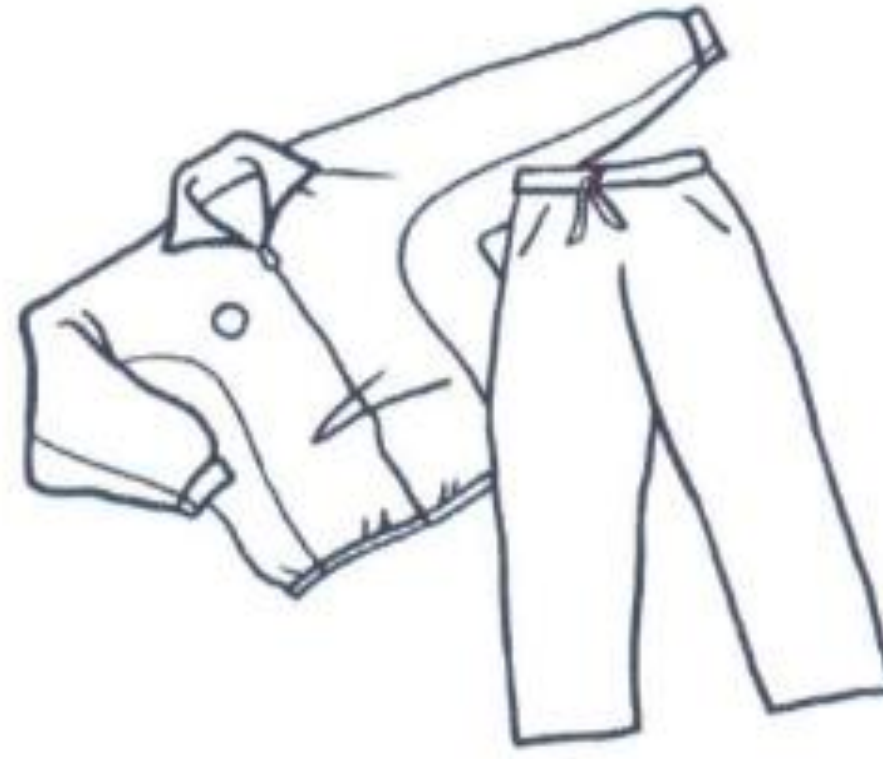

TA

TE

TI

TO

TU

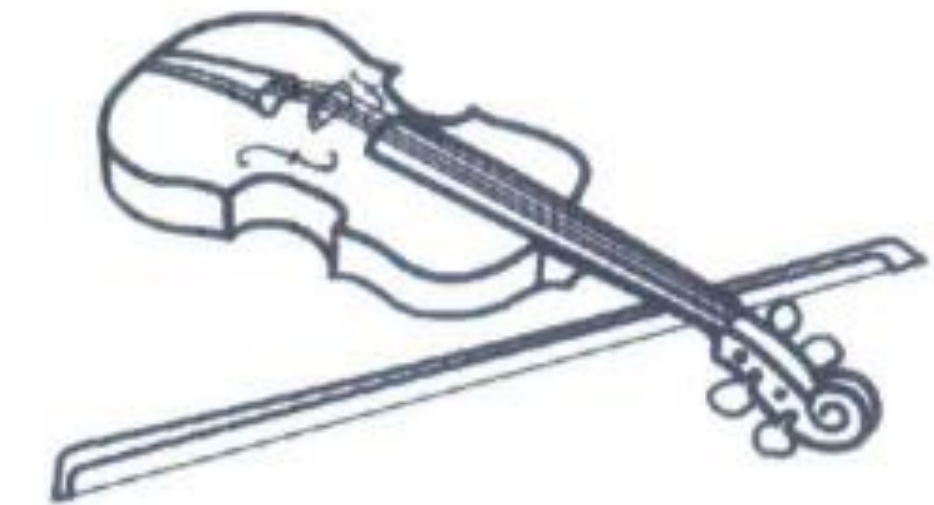

VA

VE

VI

VO

VU

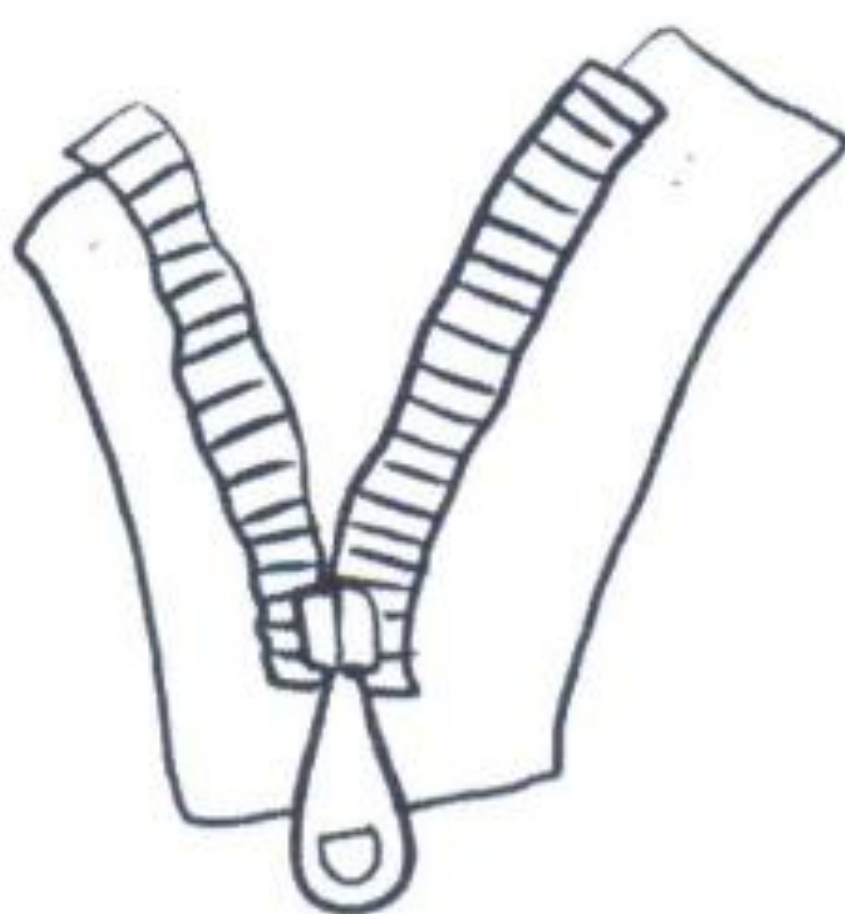

ZA

ZE

ZI

ZO

ZU

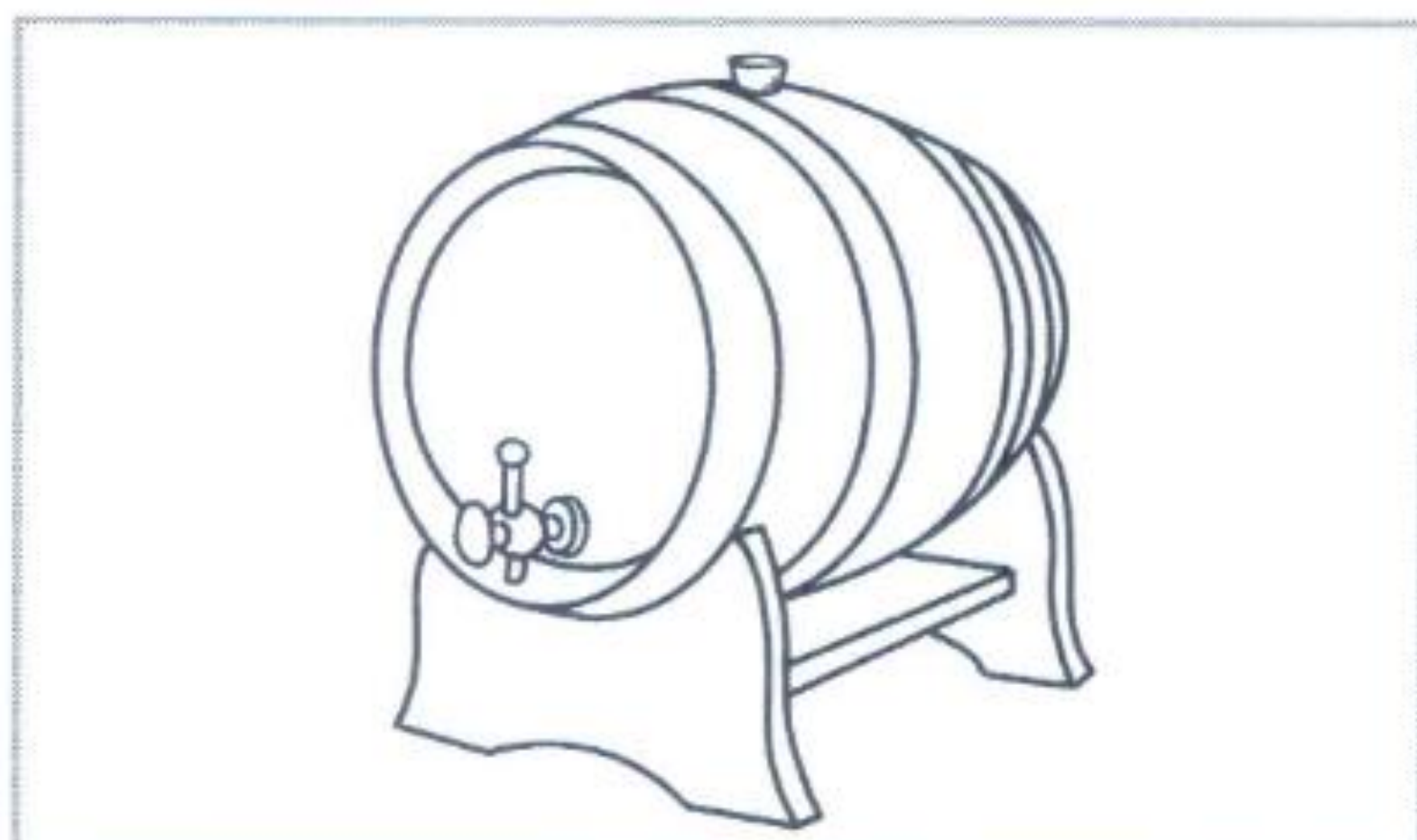

BOT

TE
TA

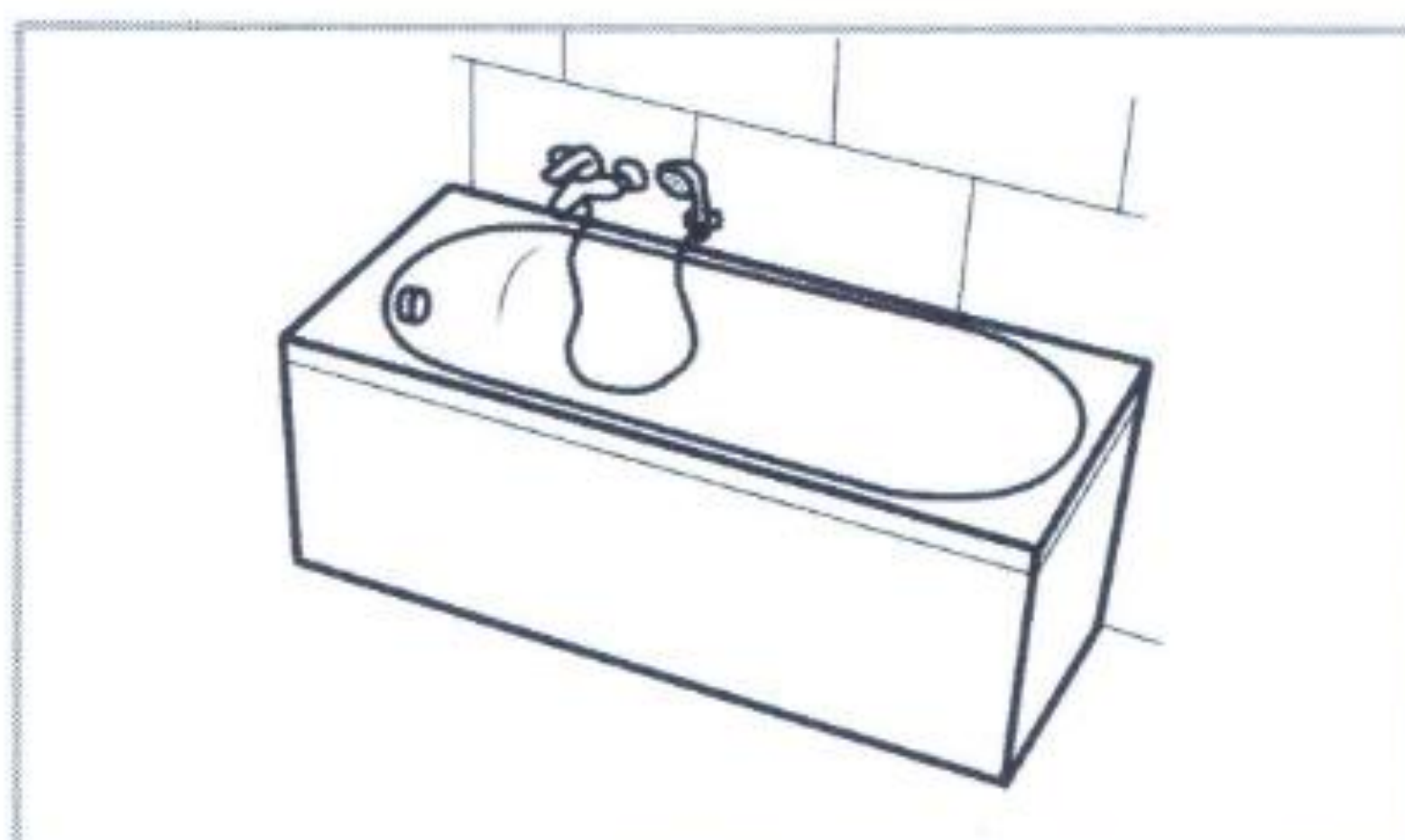

SCA

VA
VO

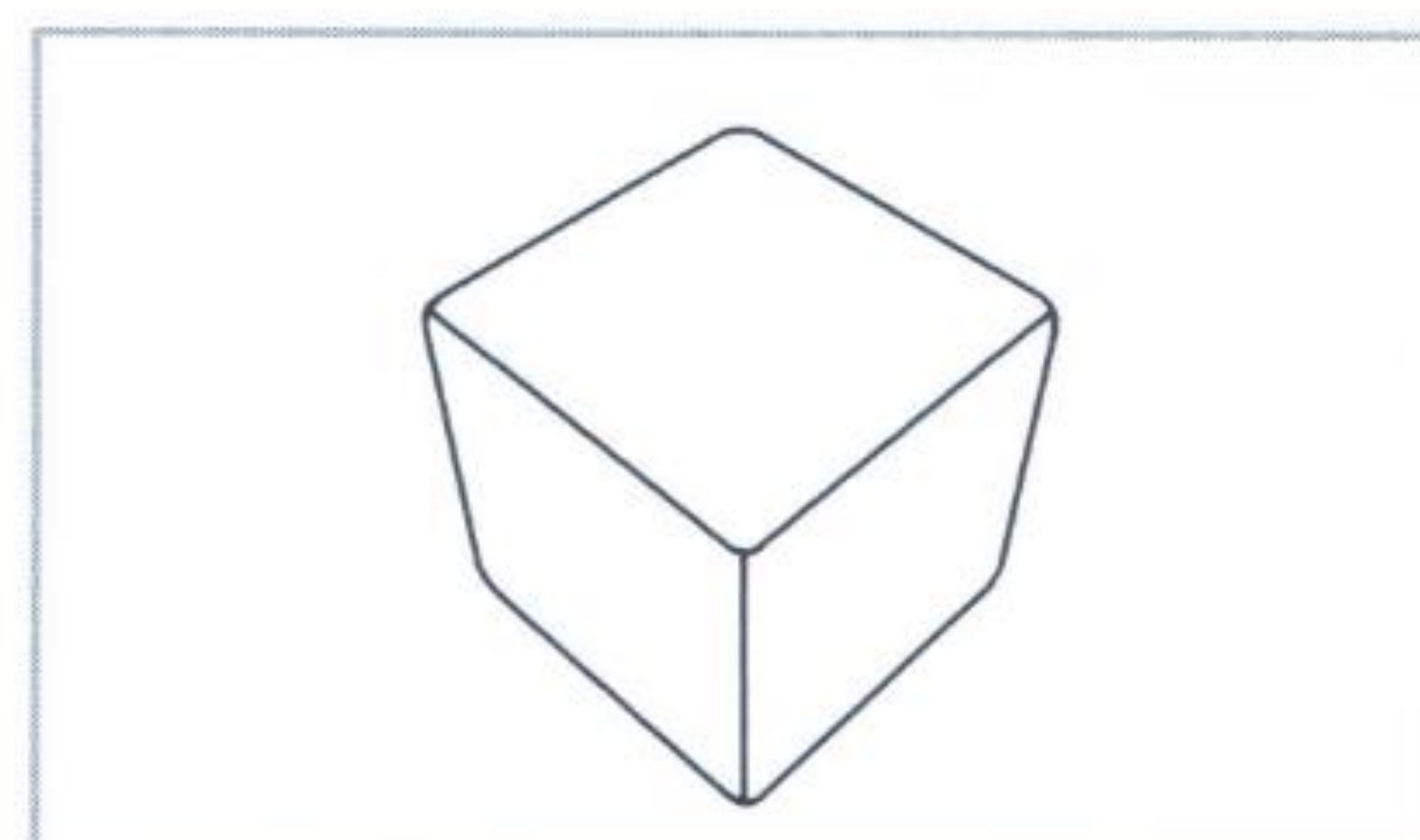

CU

BO
BE

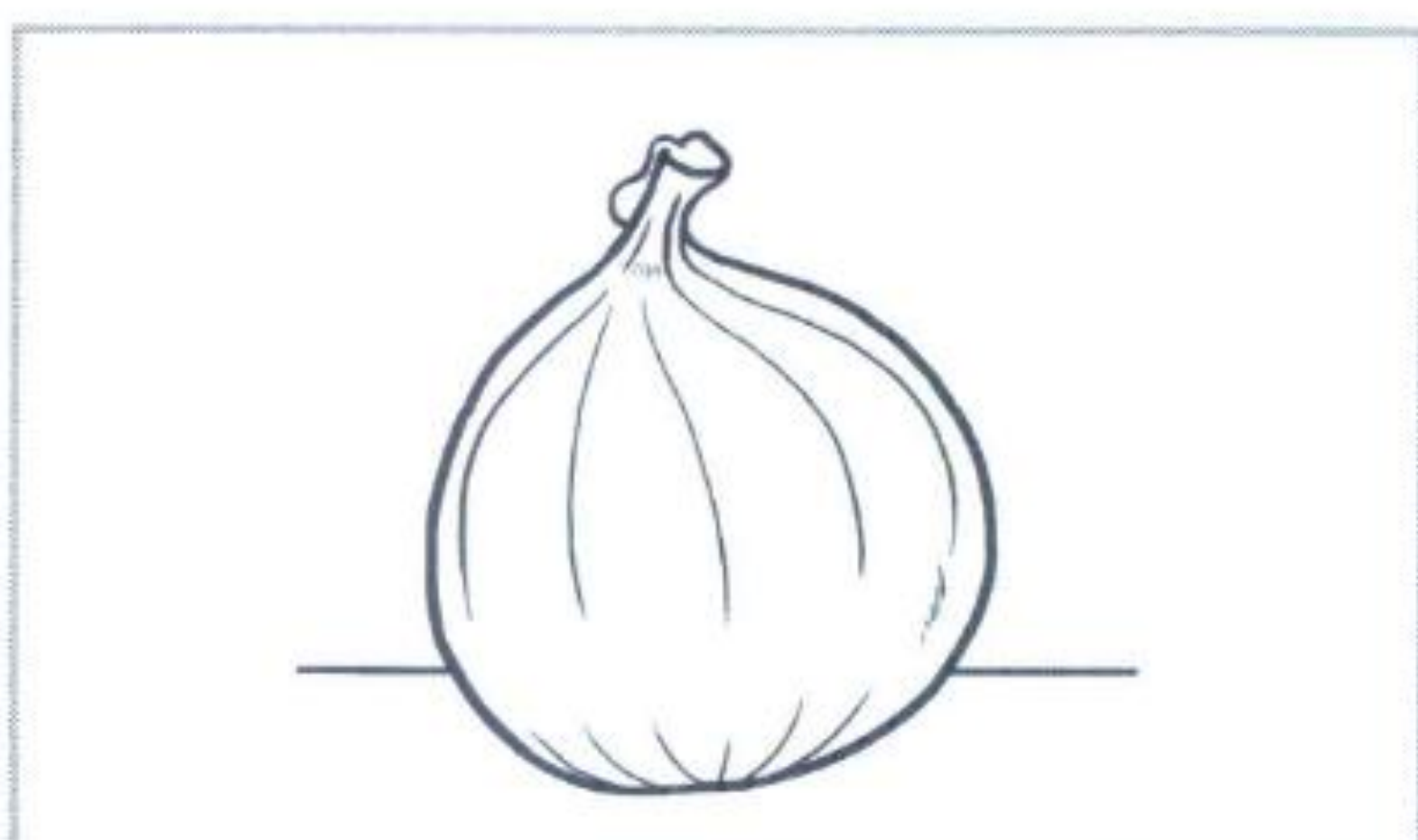

CO

FA
FI

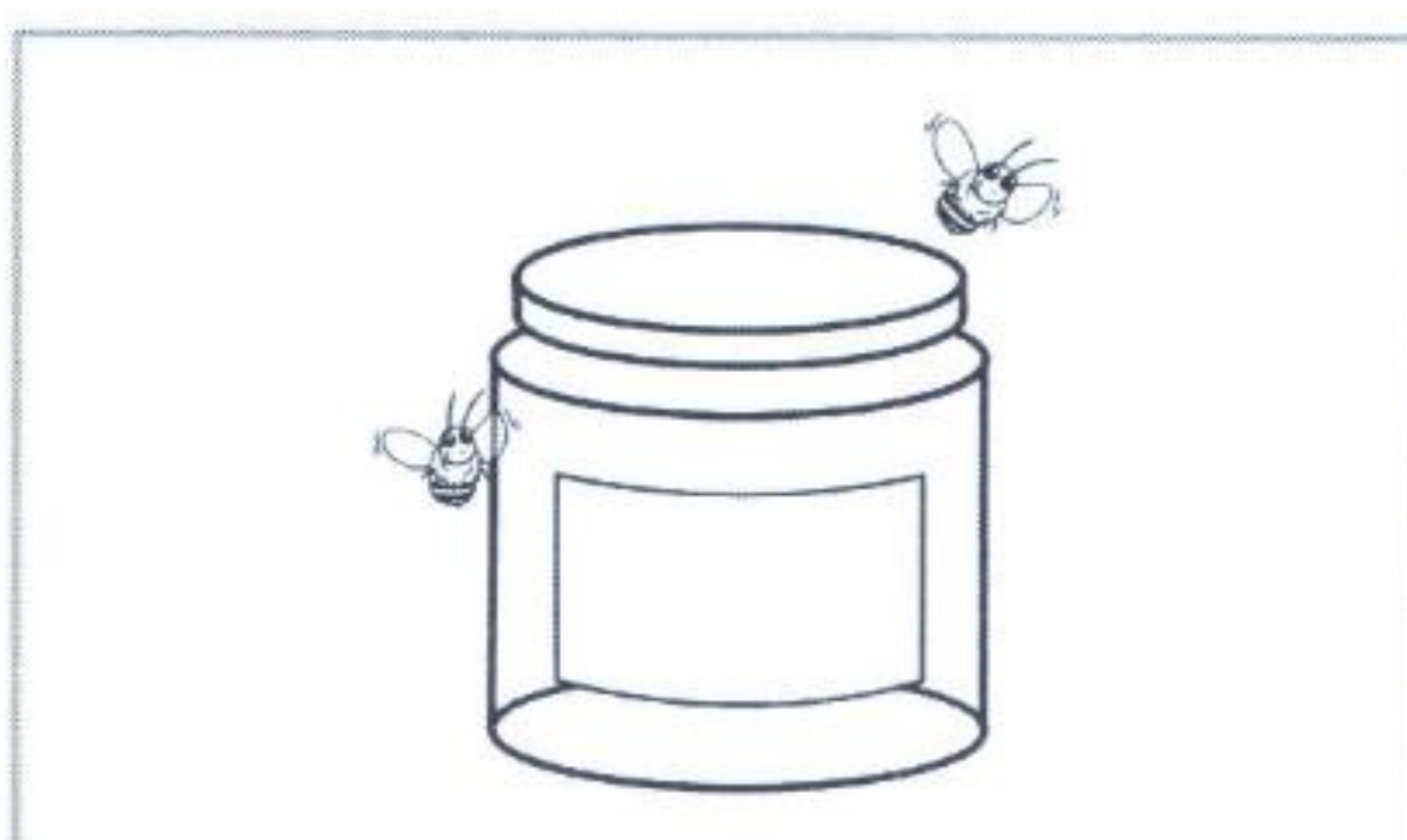

MIE

LE
LA

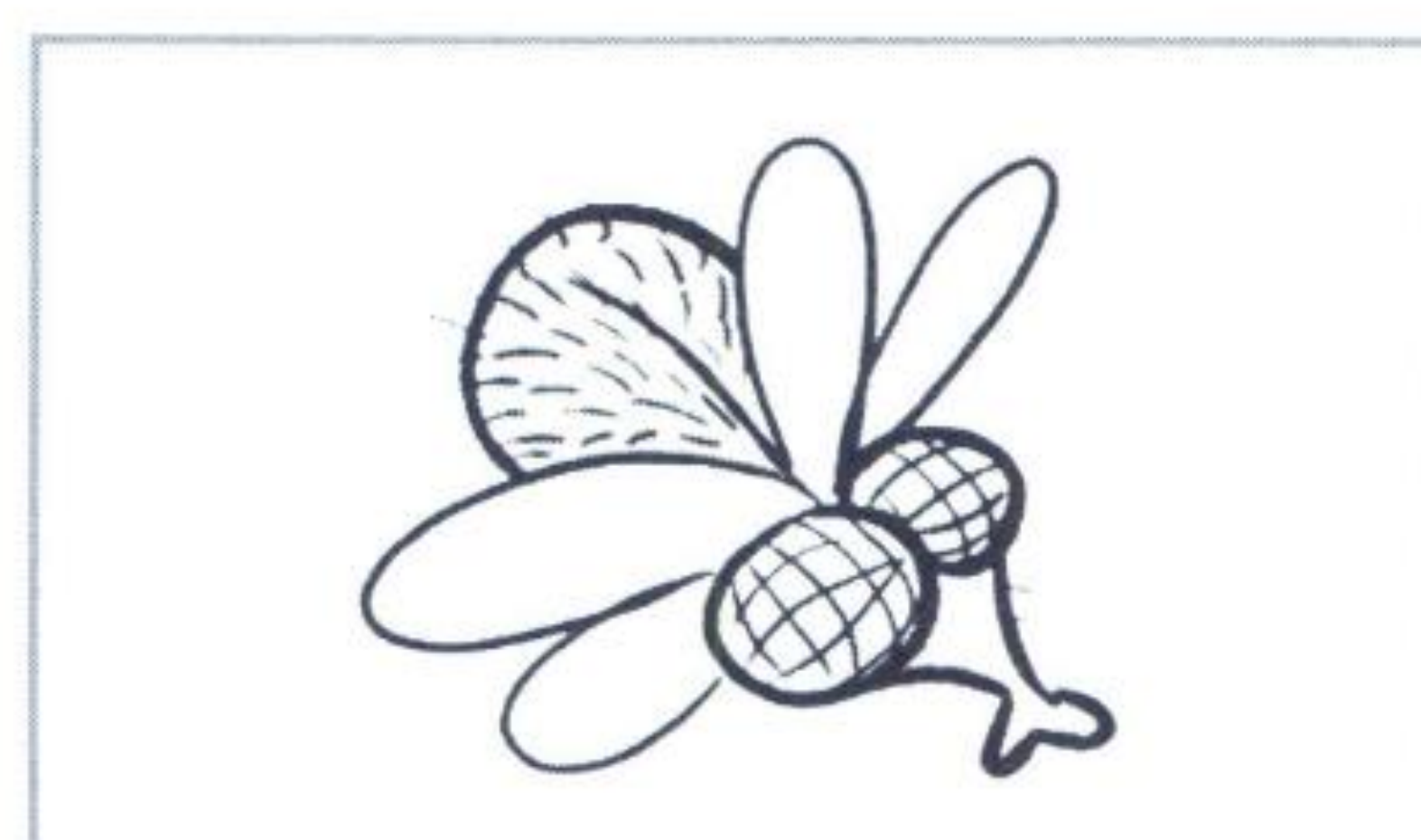

SCA

MI
MO

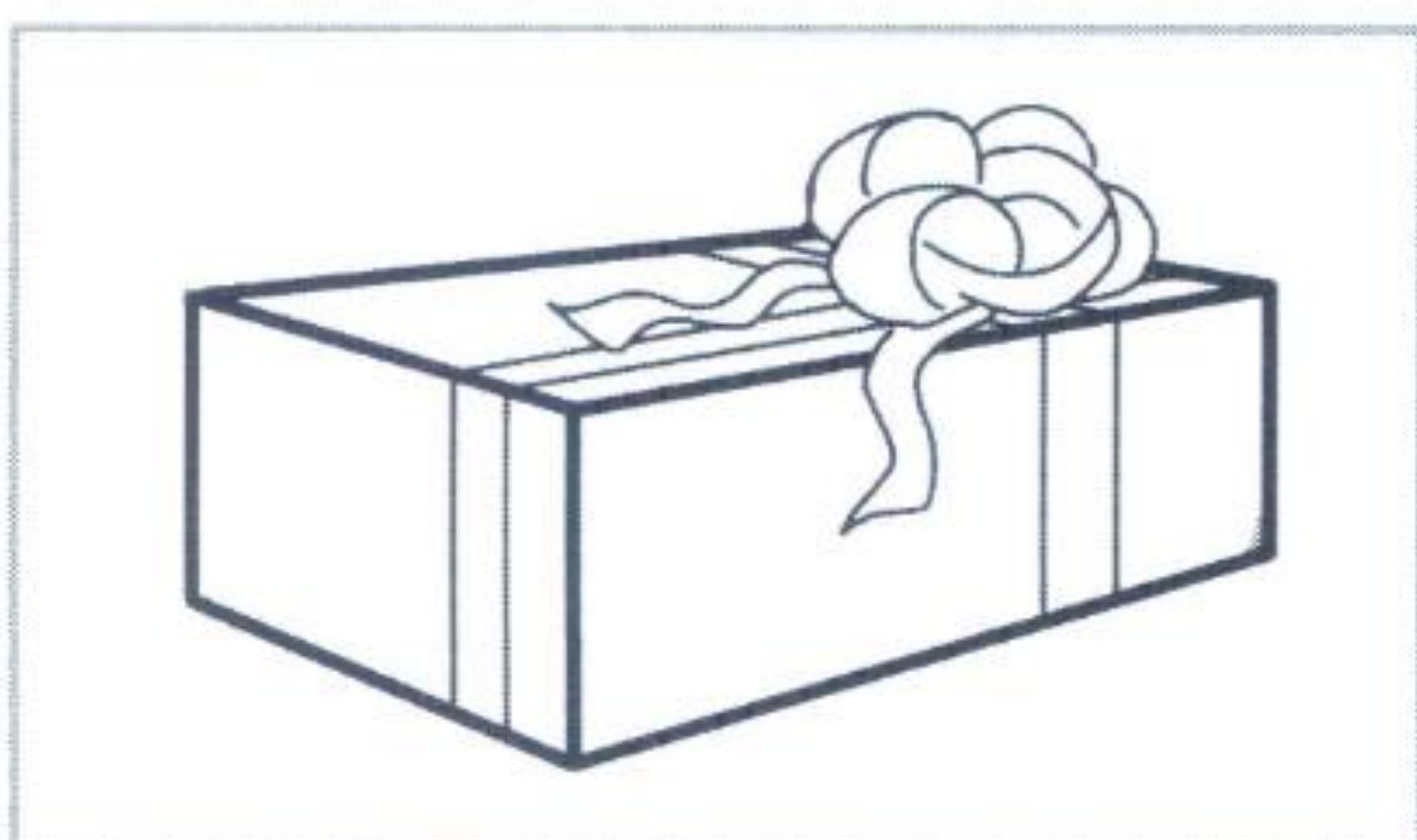

NO

DO
DI

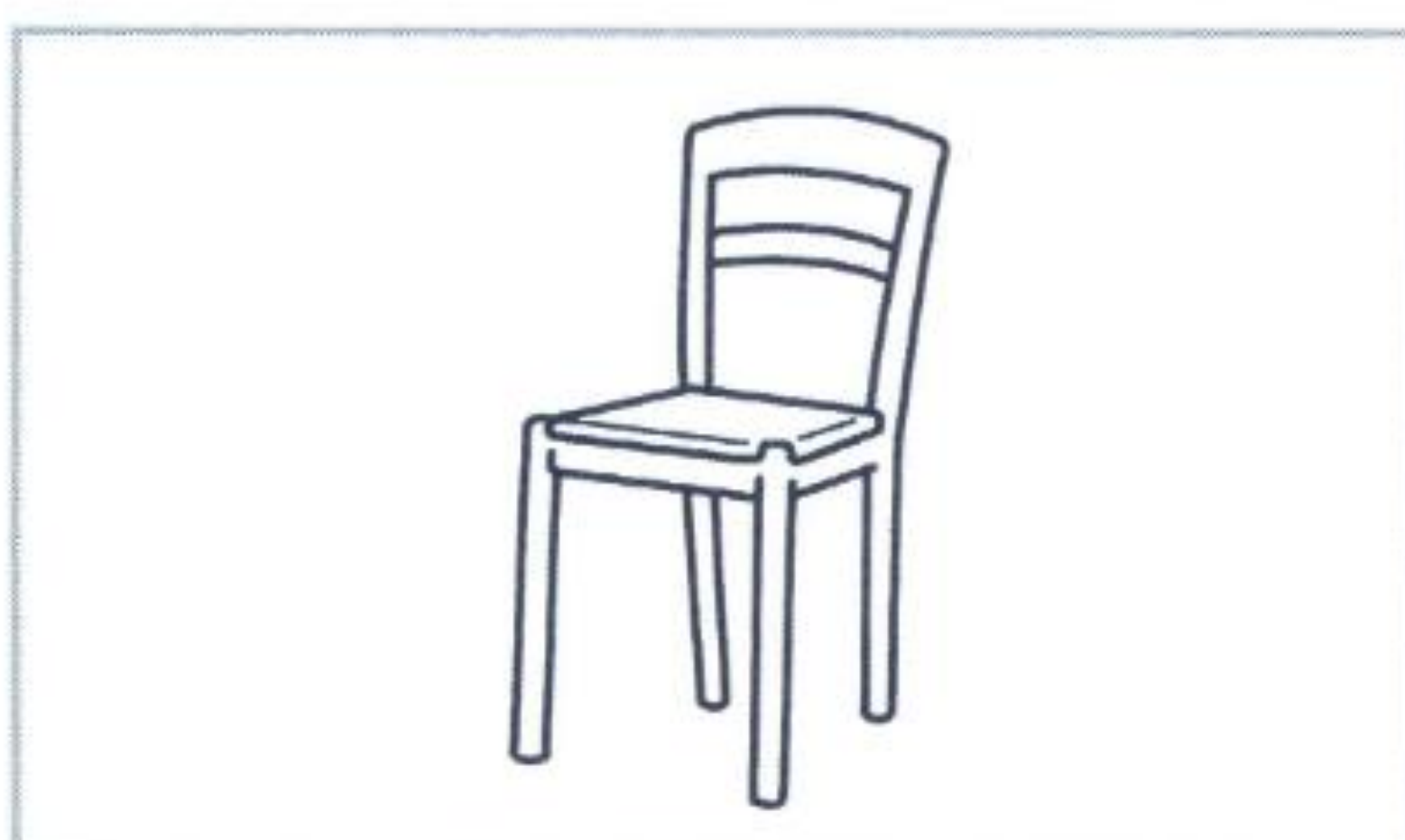

DIA

SI
SE

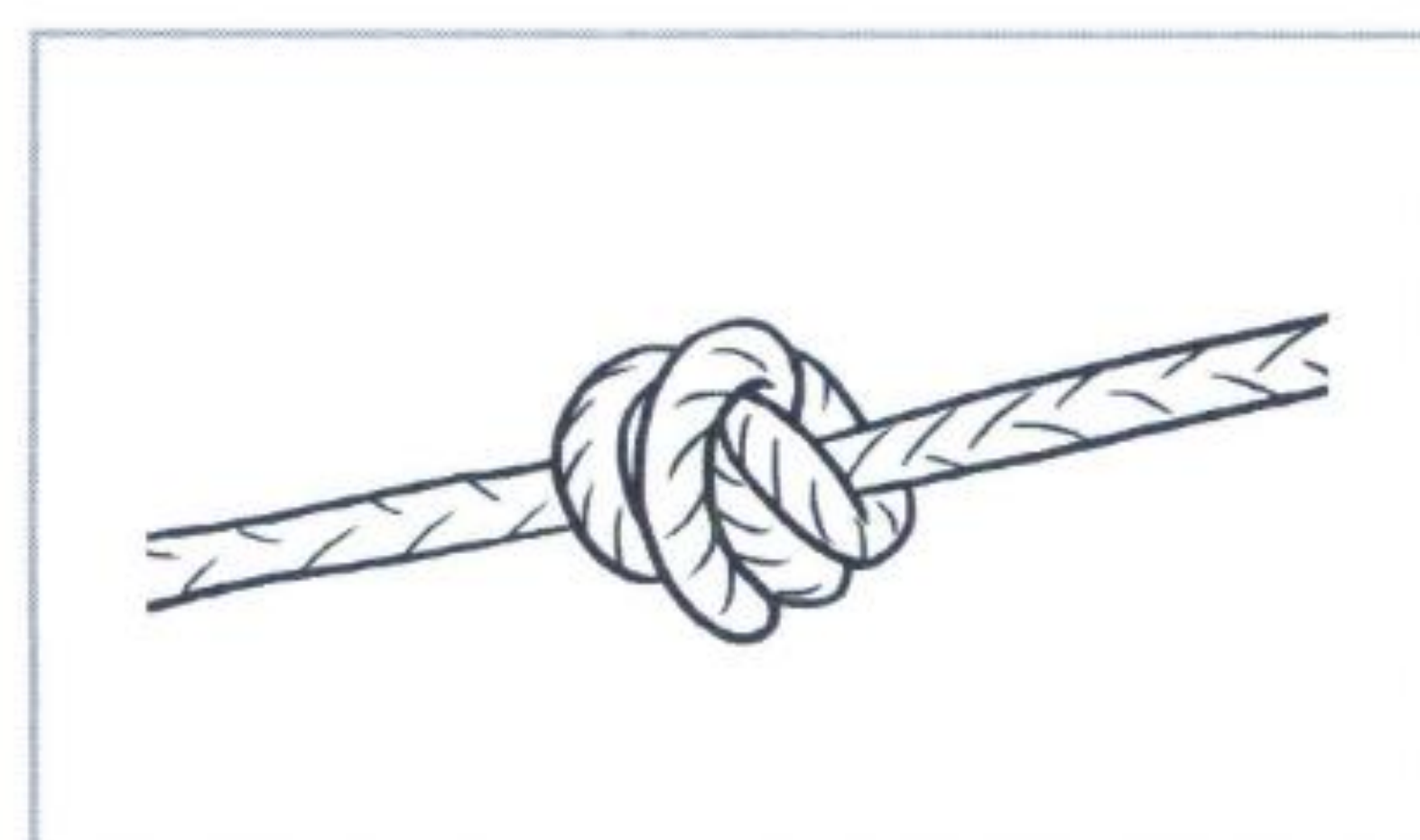

DO

NO
NA

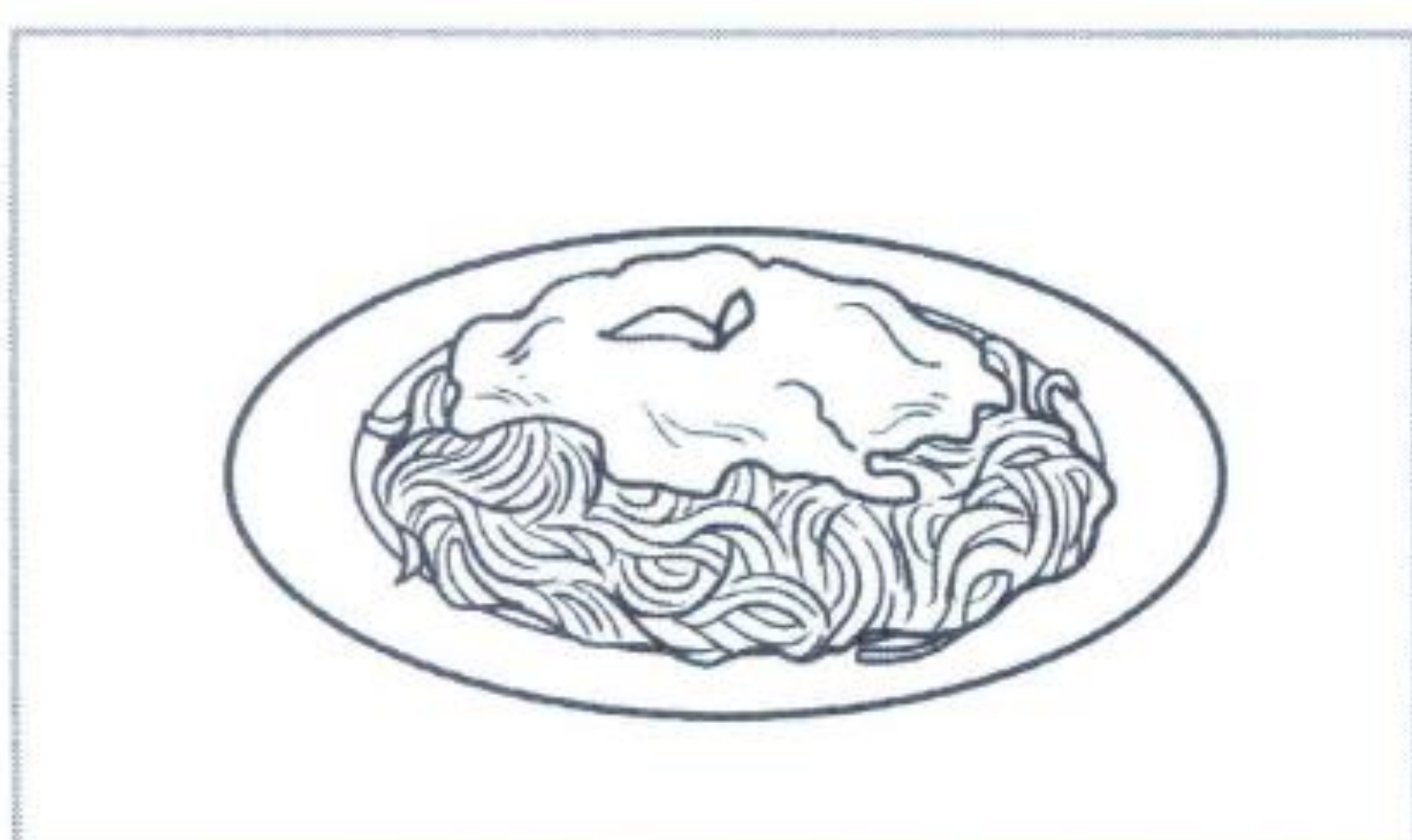

STA

PA
PO

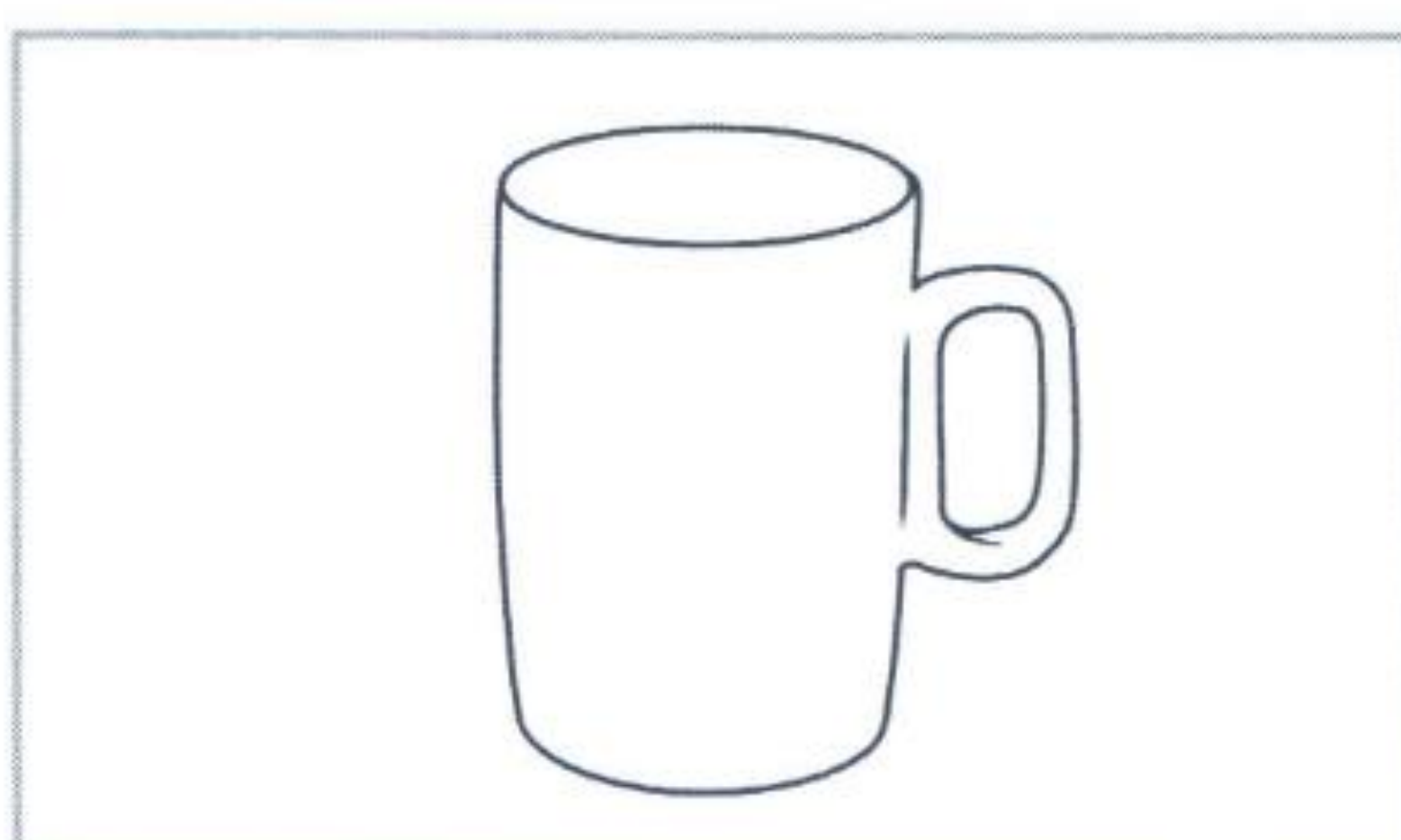

TAZ

ZI
ZA



DIO

RA
RO



OSSERVA IL DISEGNO E COMPONI LA PAROLA
RIPASSANDO LA SILLABA GIUSTA



SCHEDA

59

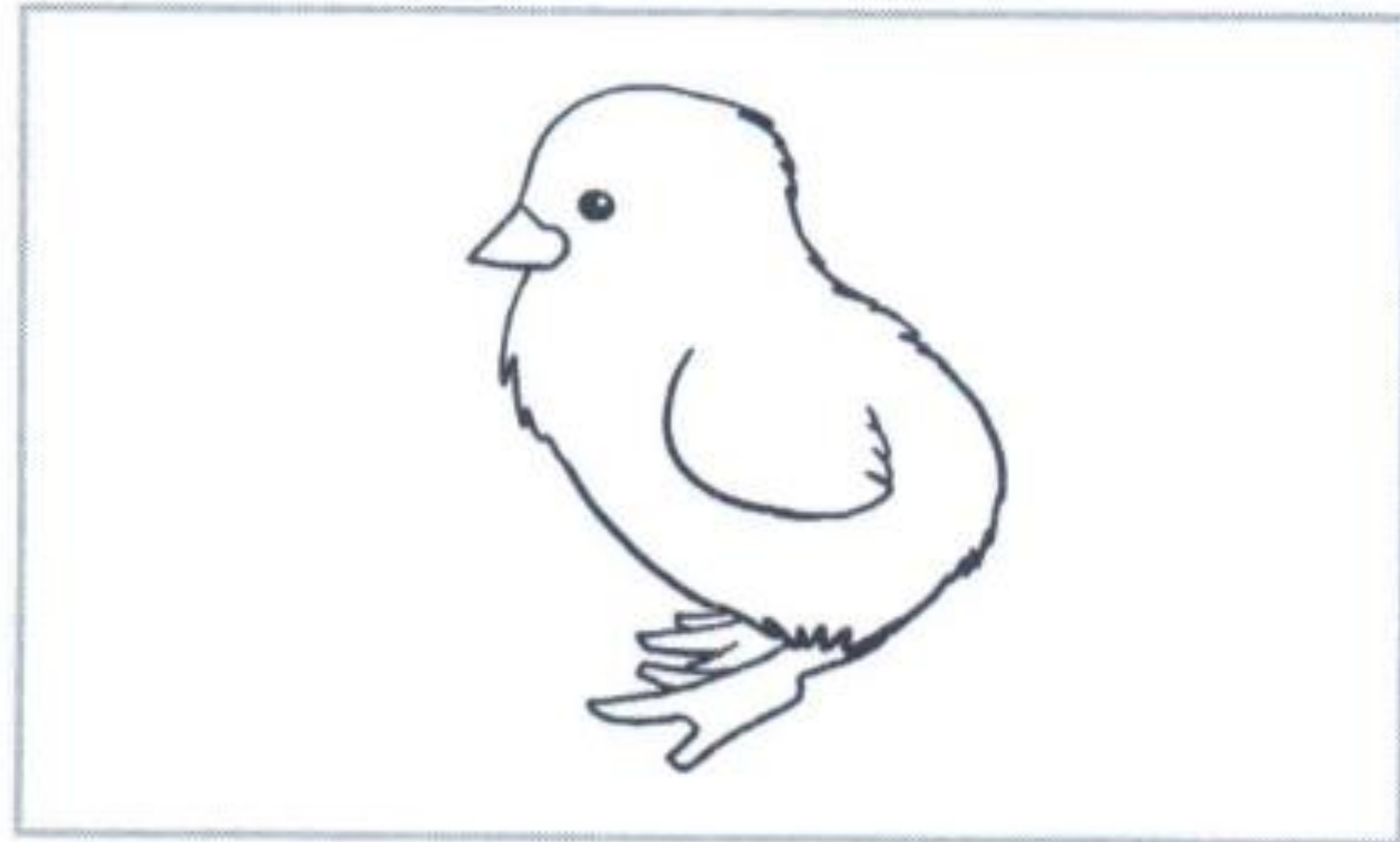

PUL **CI** NO

MI

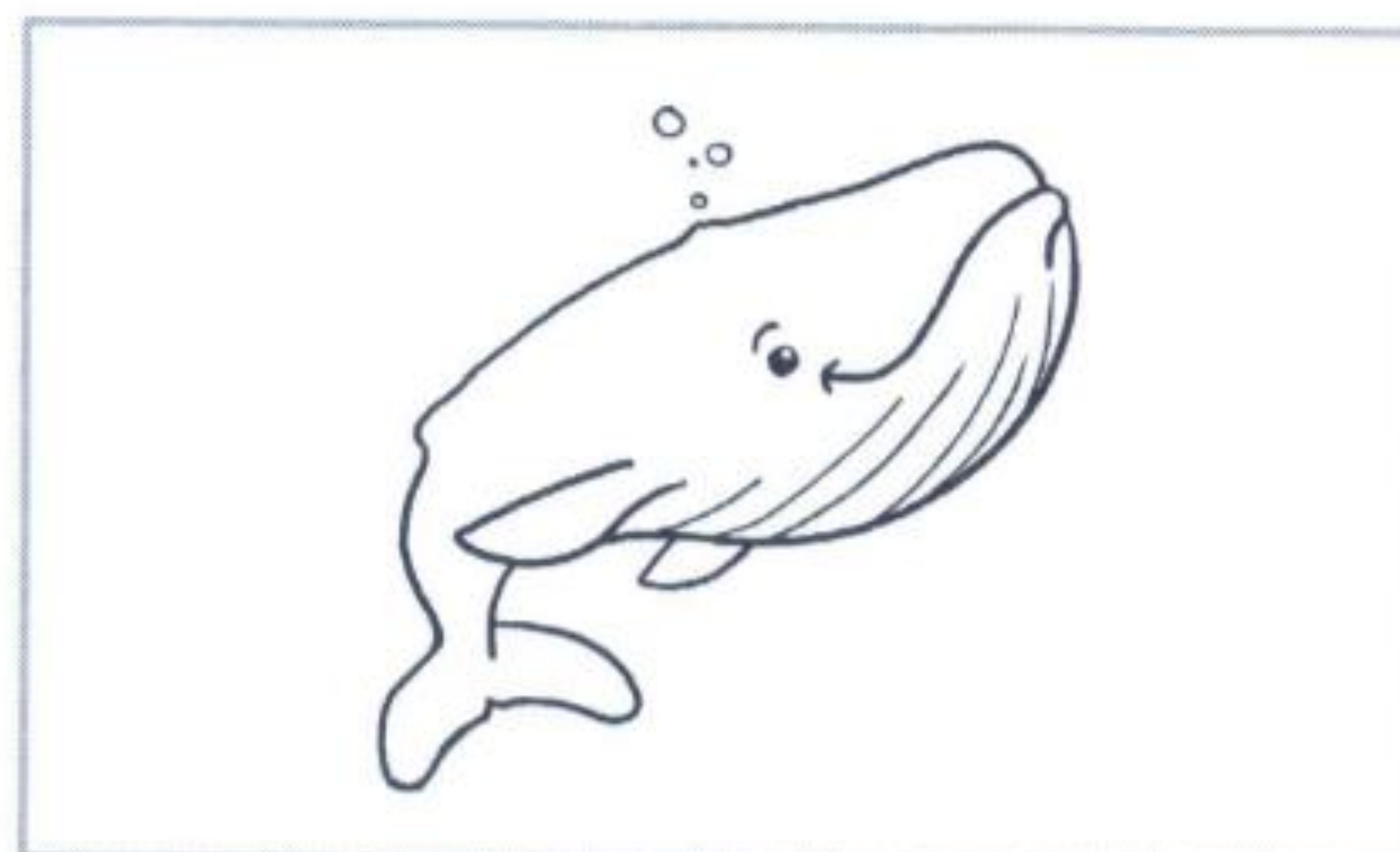

FA **LE** NA

BA

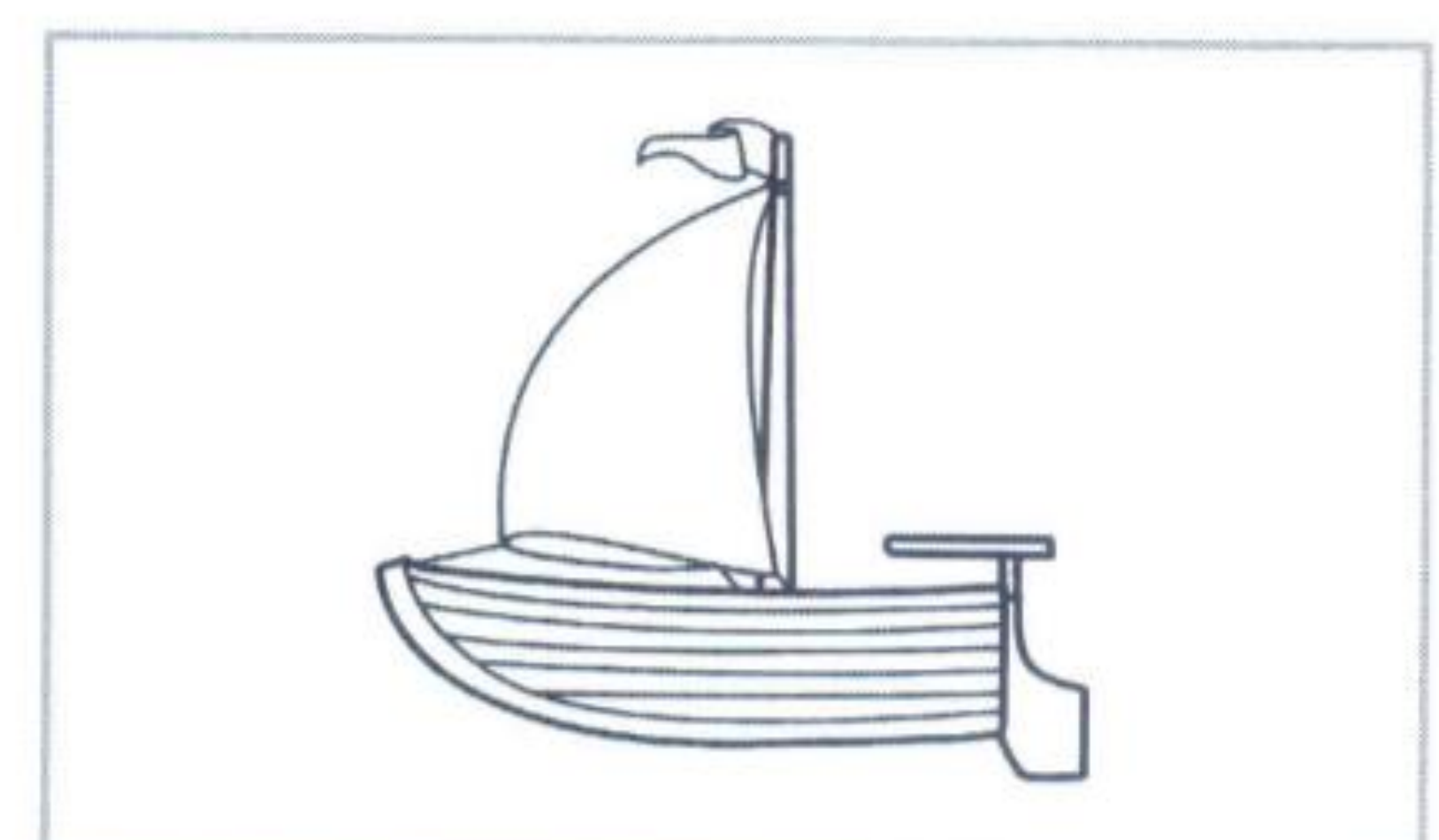

BAN **CA**

BAR

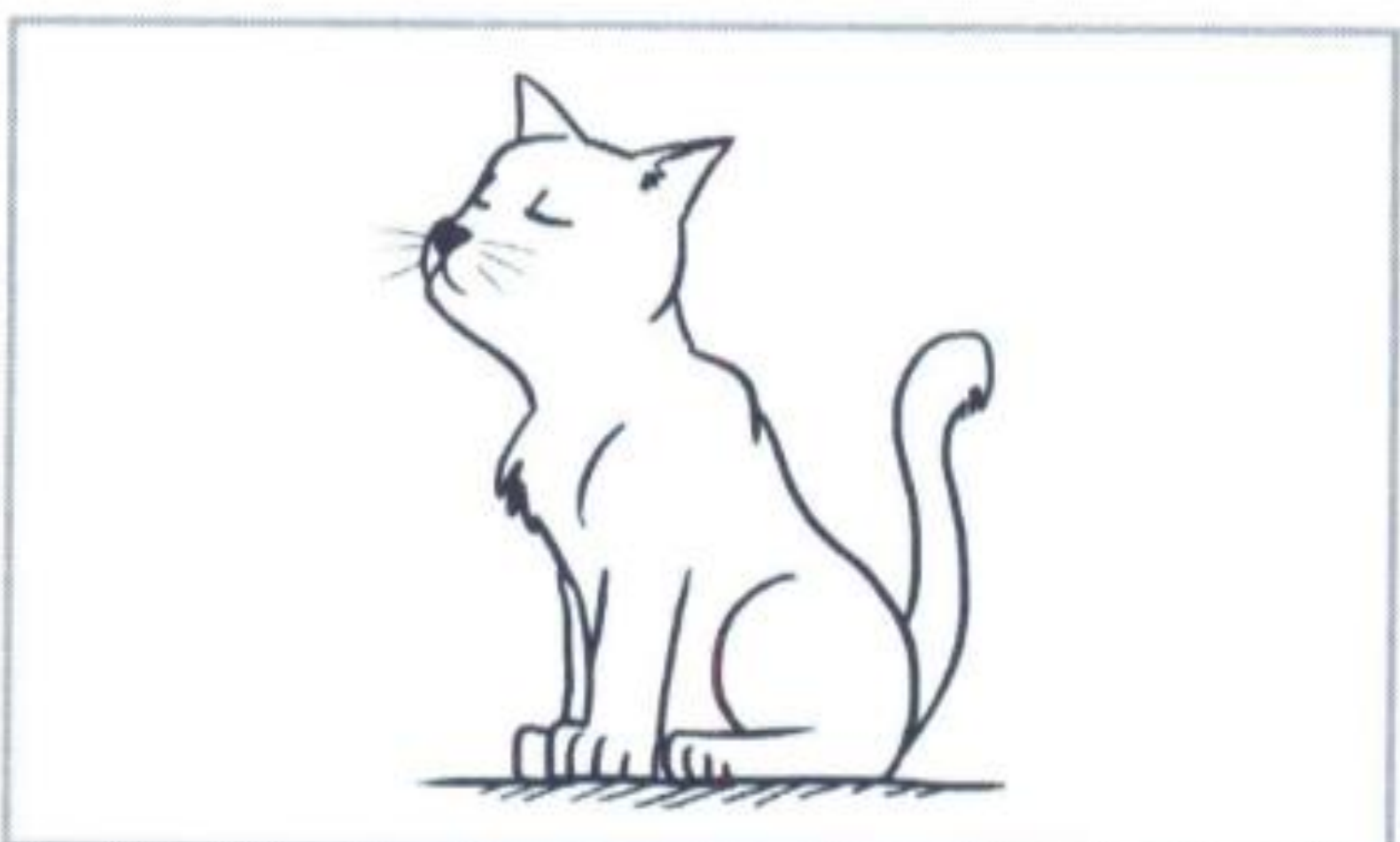

GAT **TO**

RAT

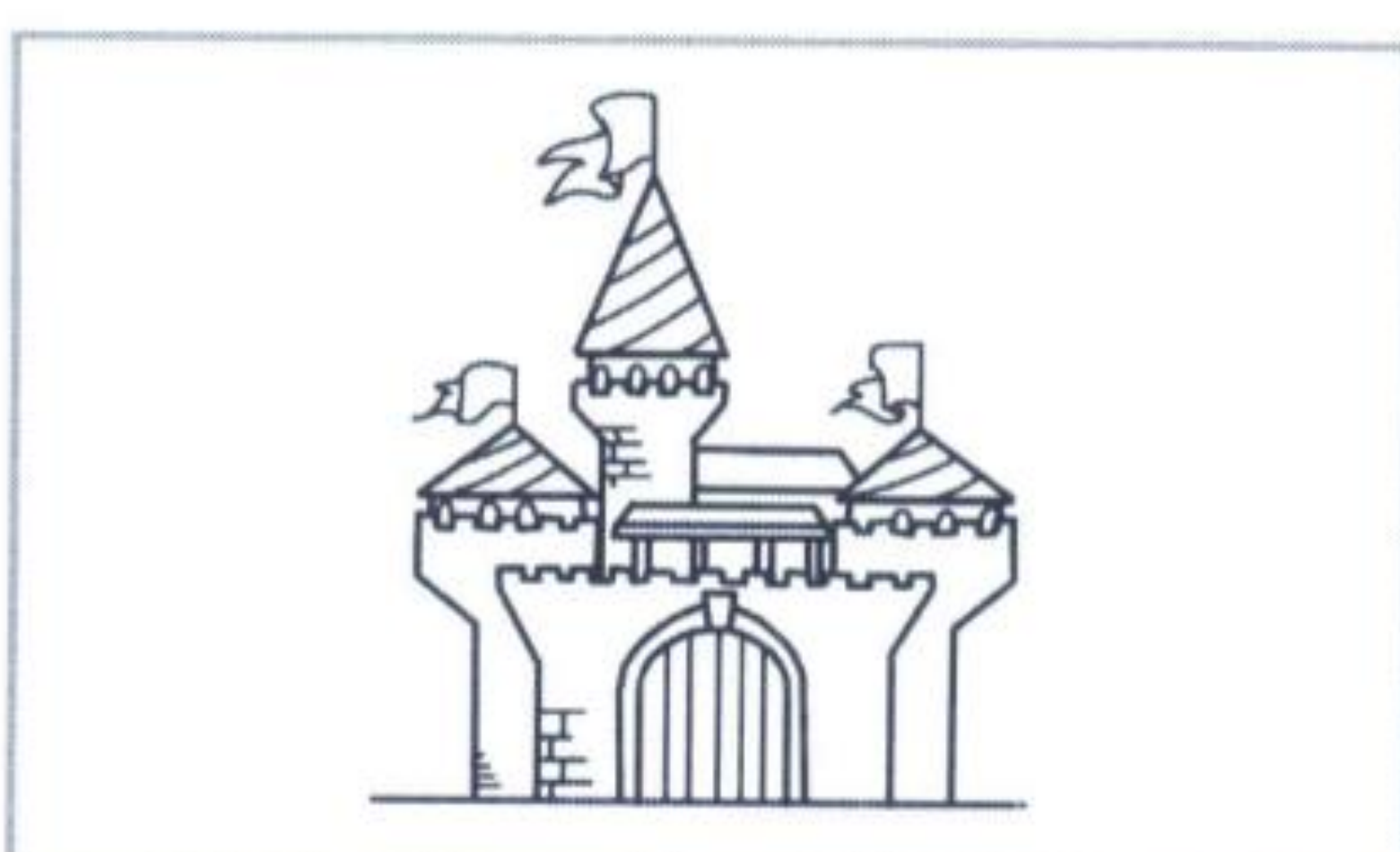

PA **STEL** LO

CA

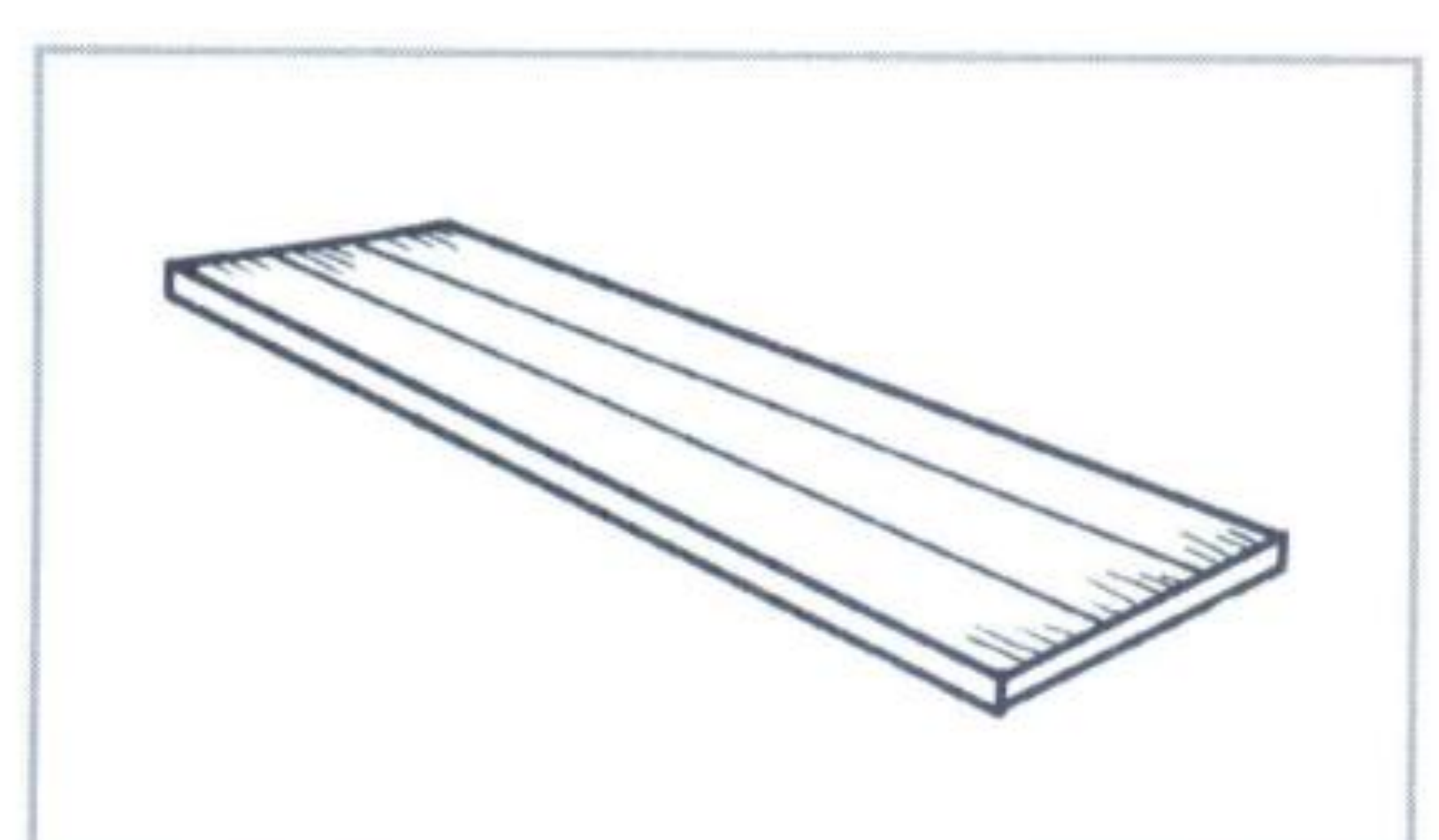

LE **GNO**

RE



NO **VE**

NE



PAN **DA**

CA

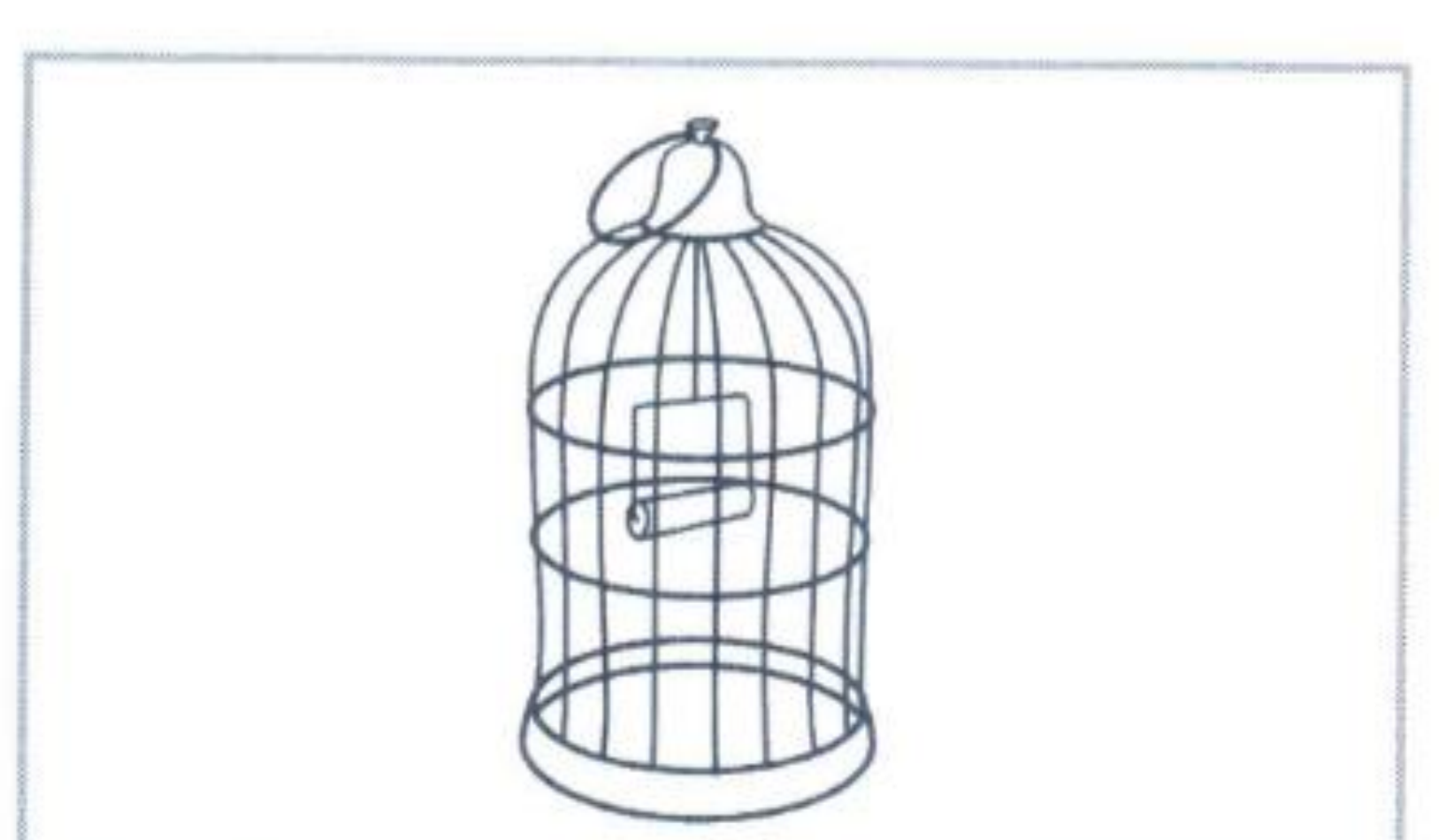

GAB **BIA**

SAB

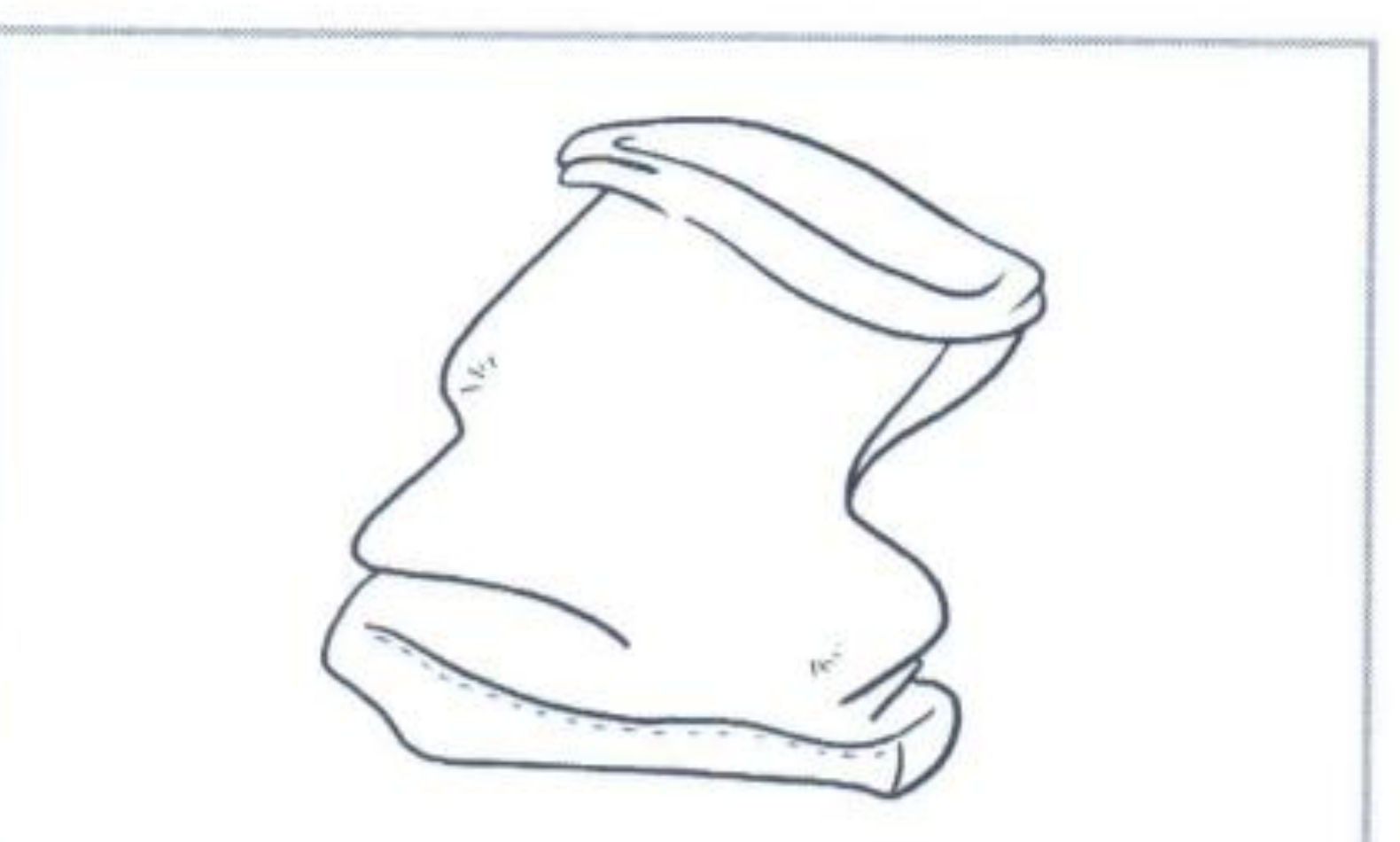

SAC **CO**

TAC

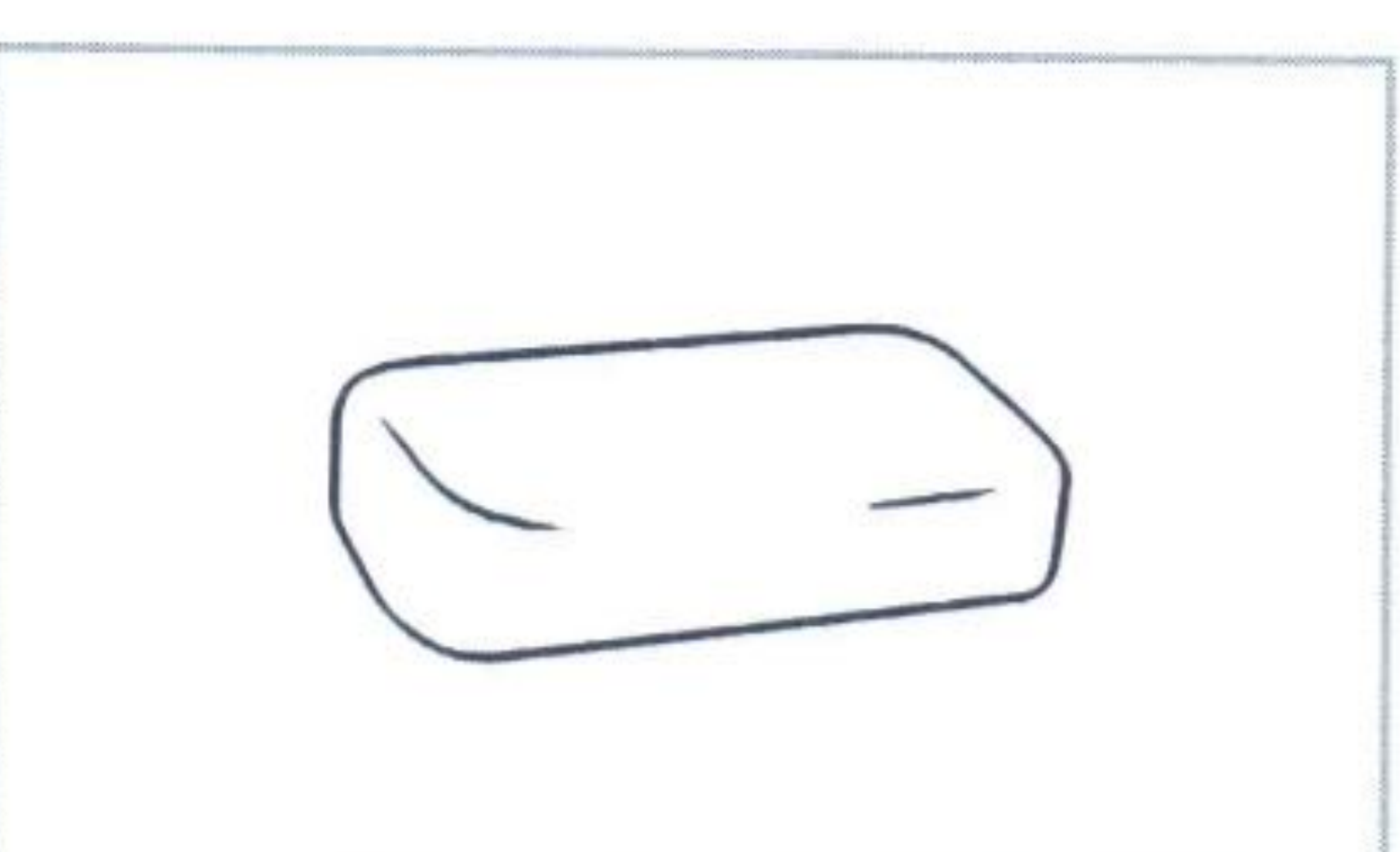

SA **LO** NE

PO

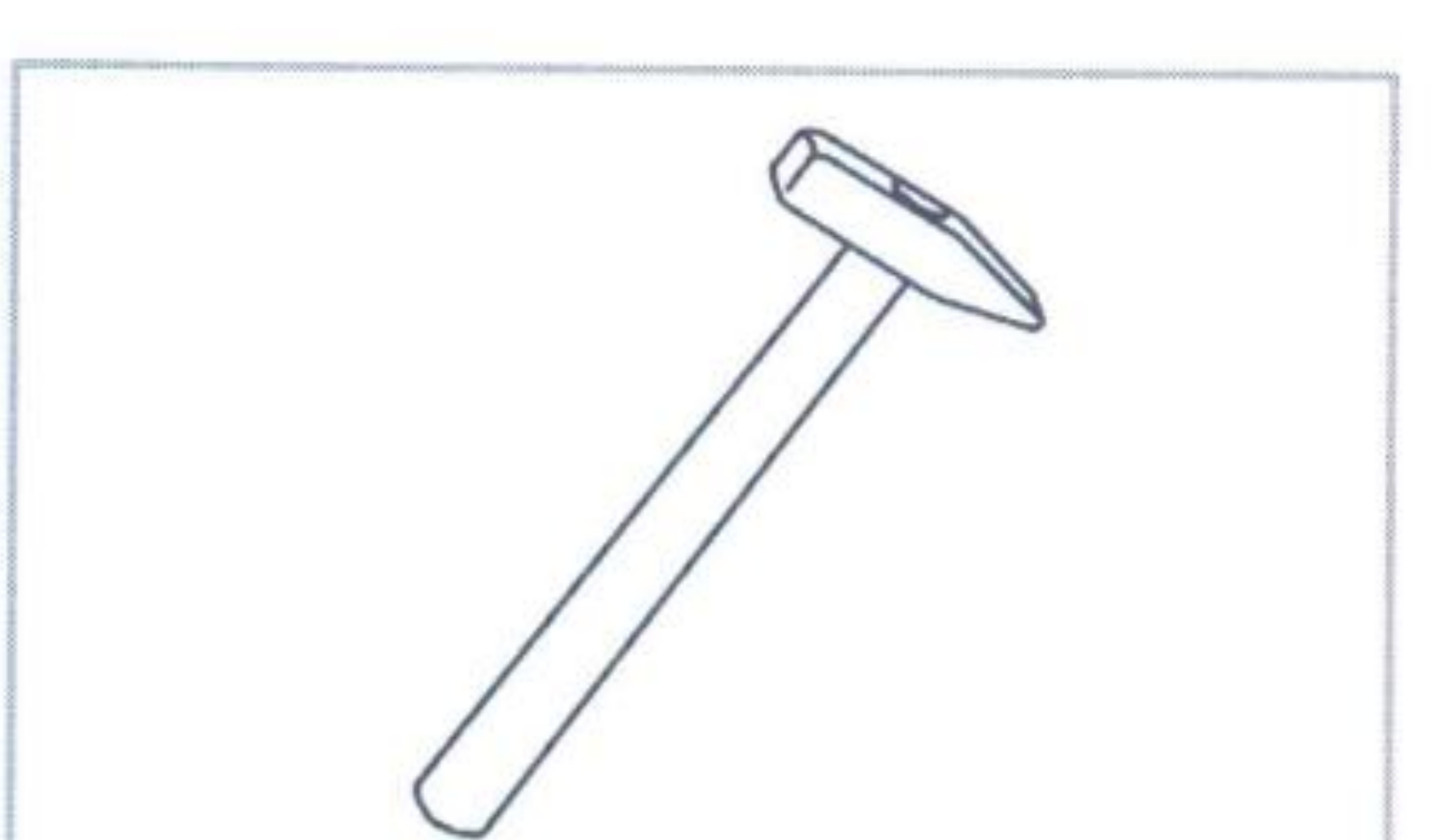

CAR **TEL** LO

MAR

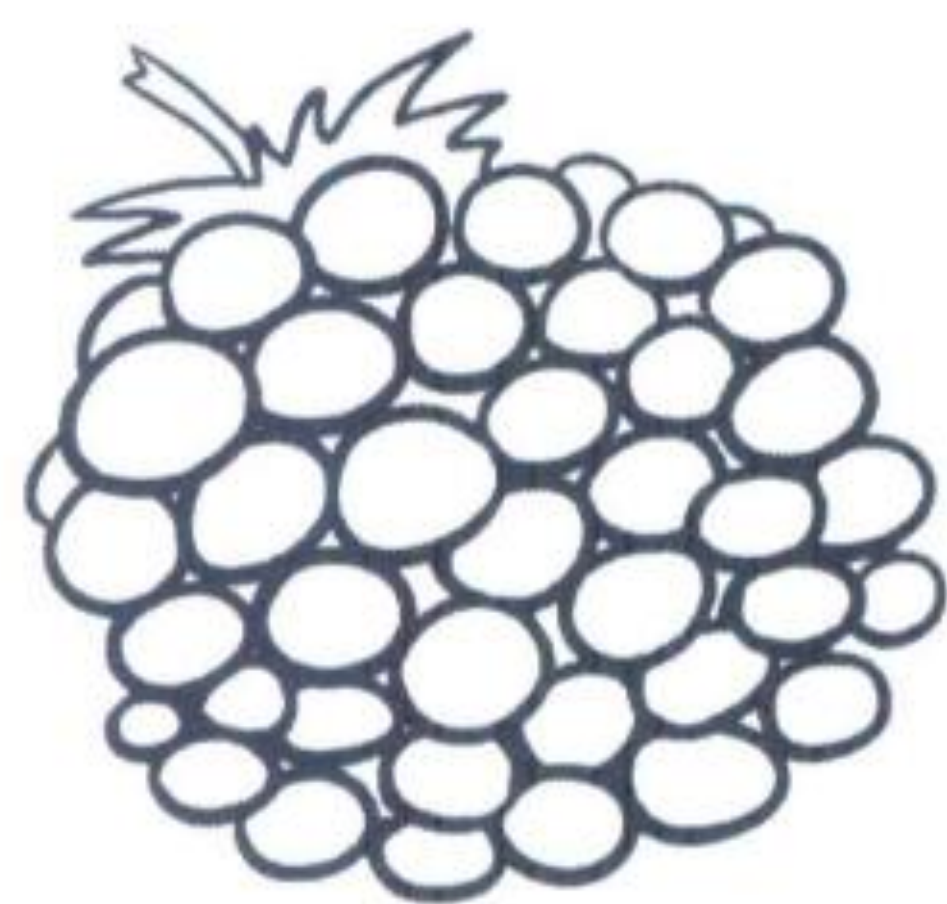

MO



OS



STEL



TROM

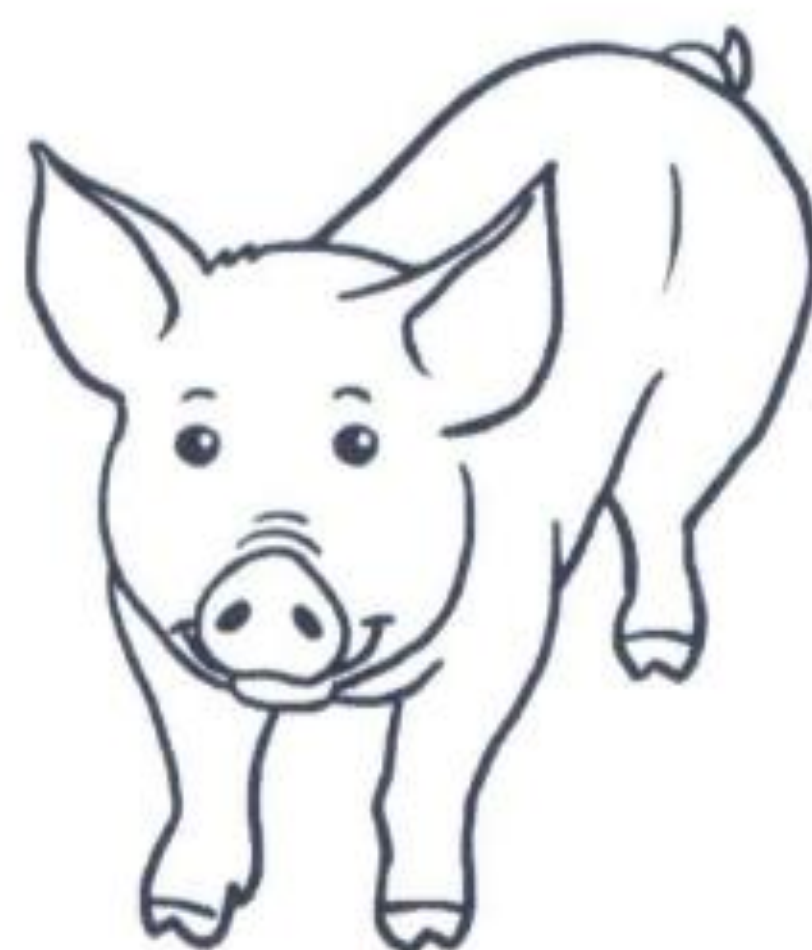

MAIA

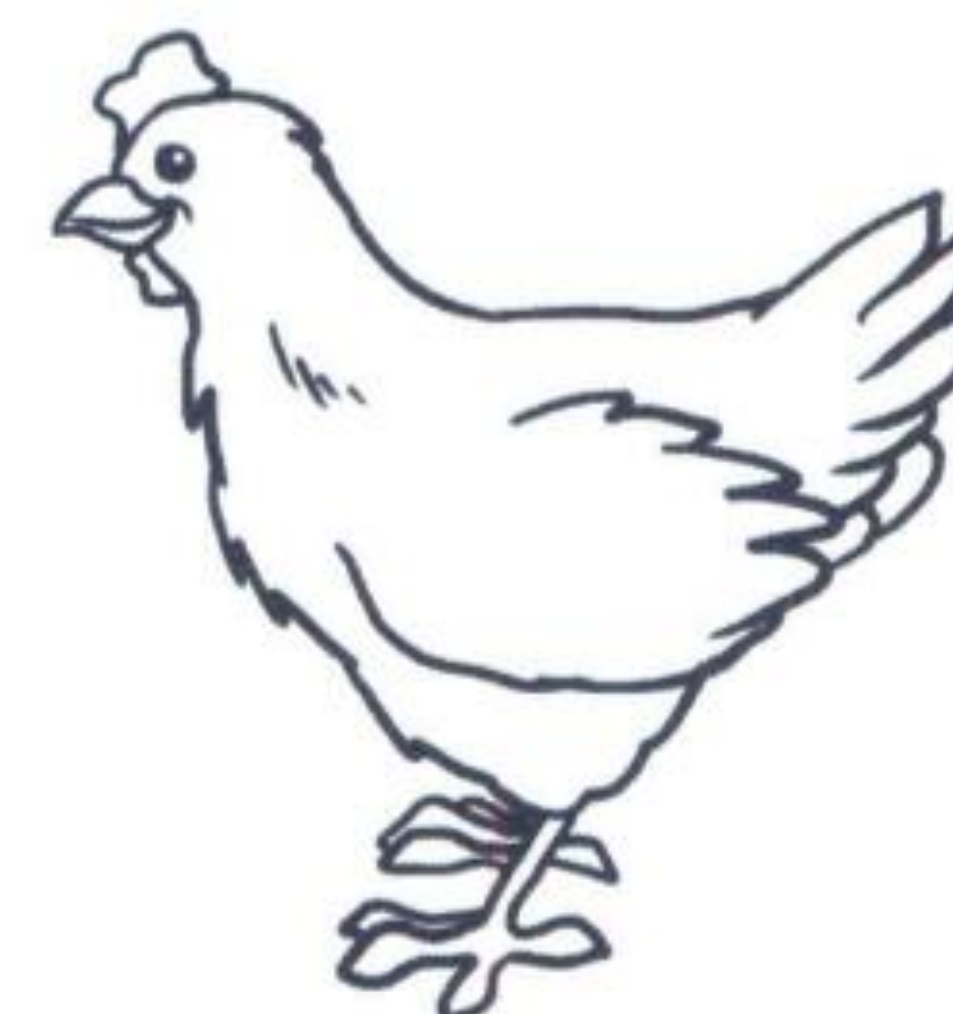

GALLI

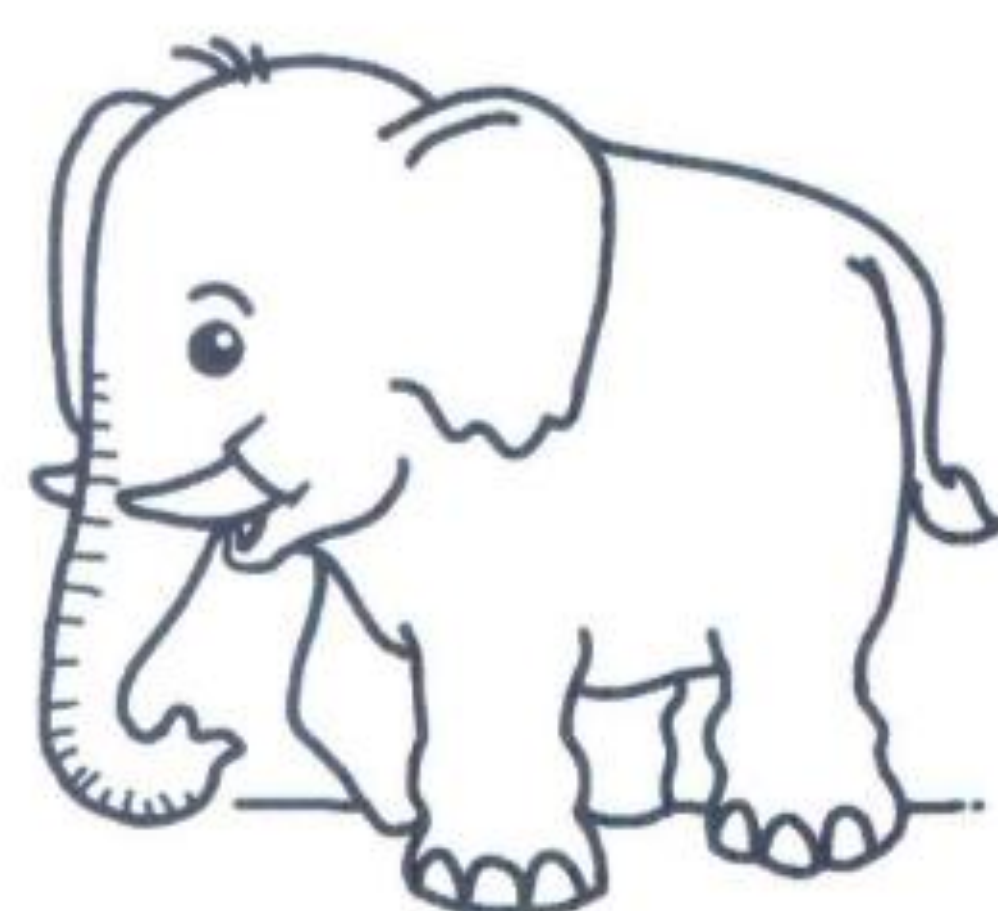

ELEFAN

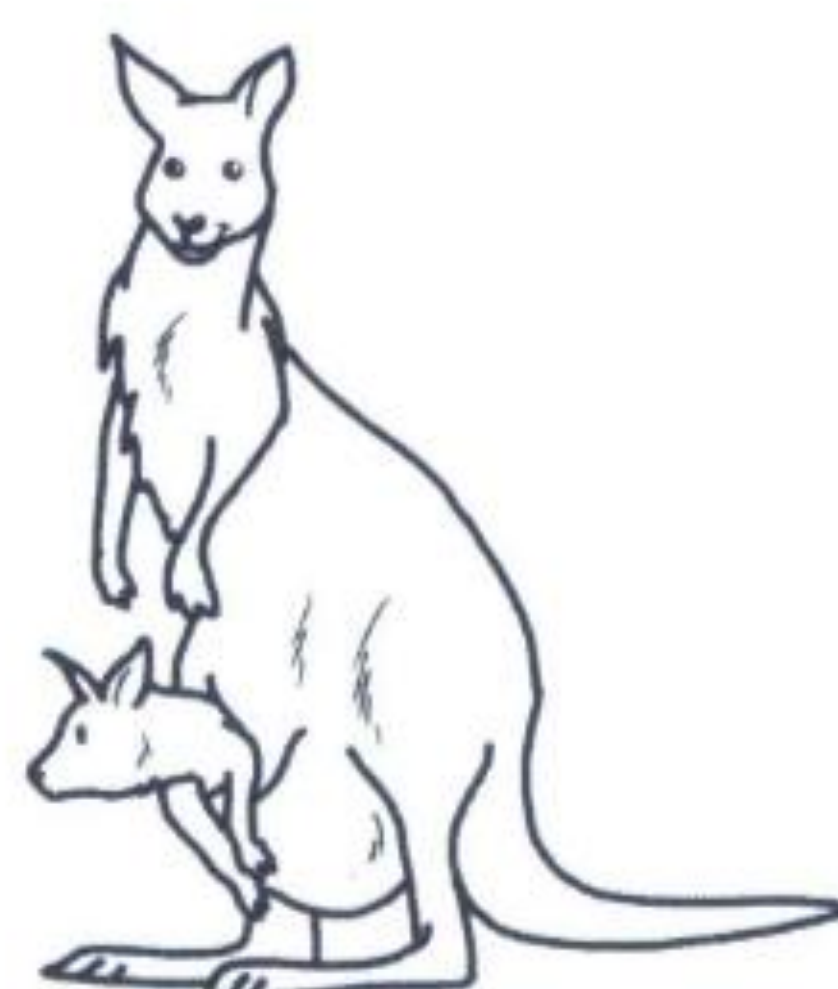

CANGU



CHIOCCIO

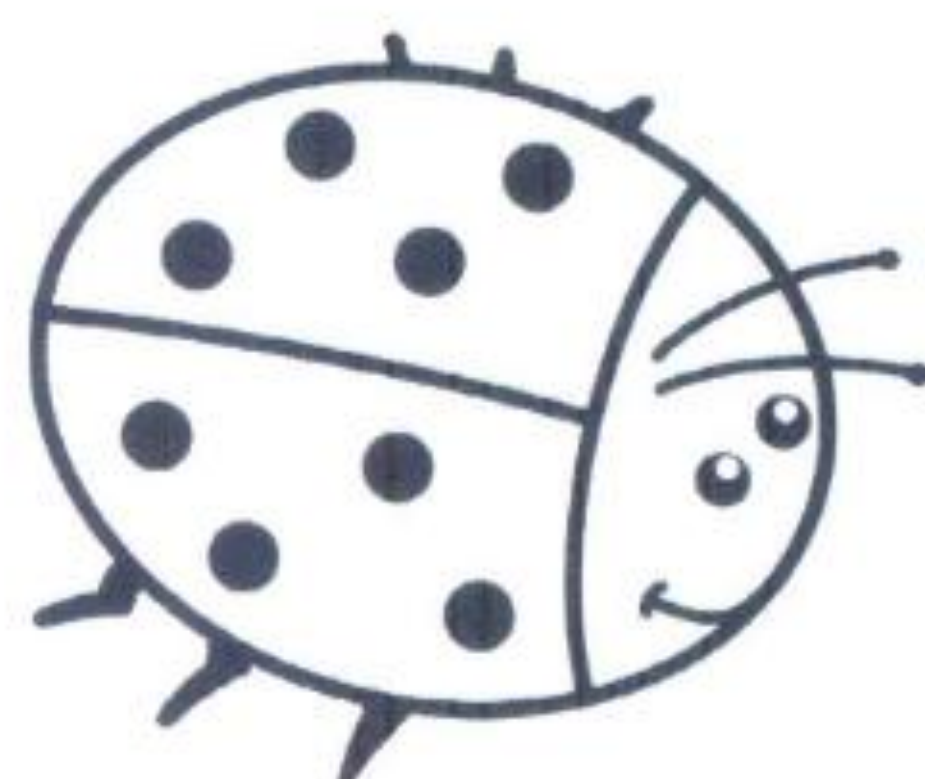

COCCINEL



BALLERI



ELICOTTE



OSSERVA IL DISEGNO E AGGIUNGI LA SILLABA
MANCANTE



SCHEDA

61

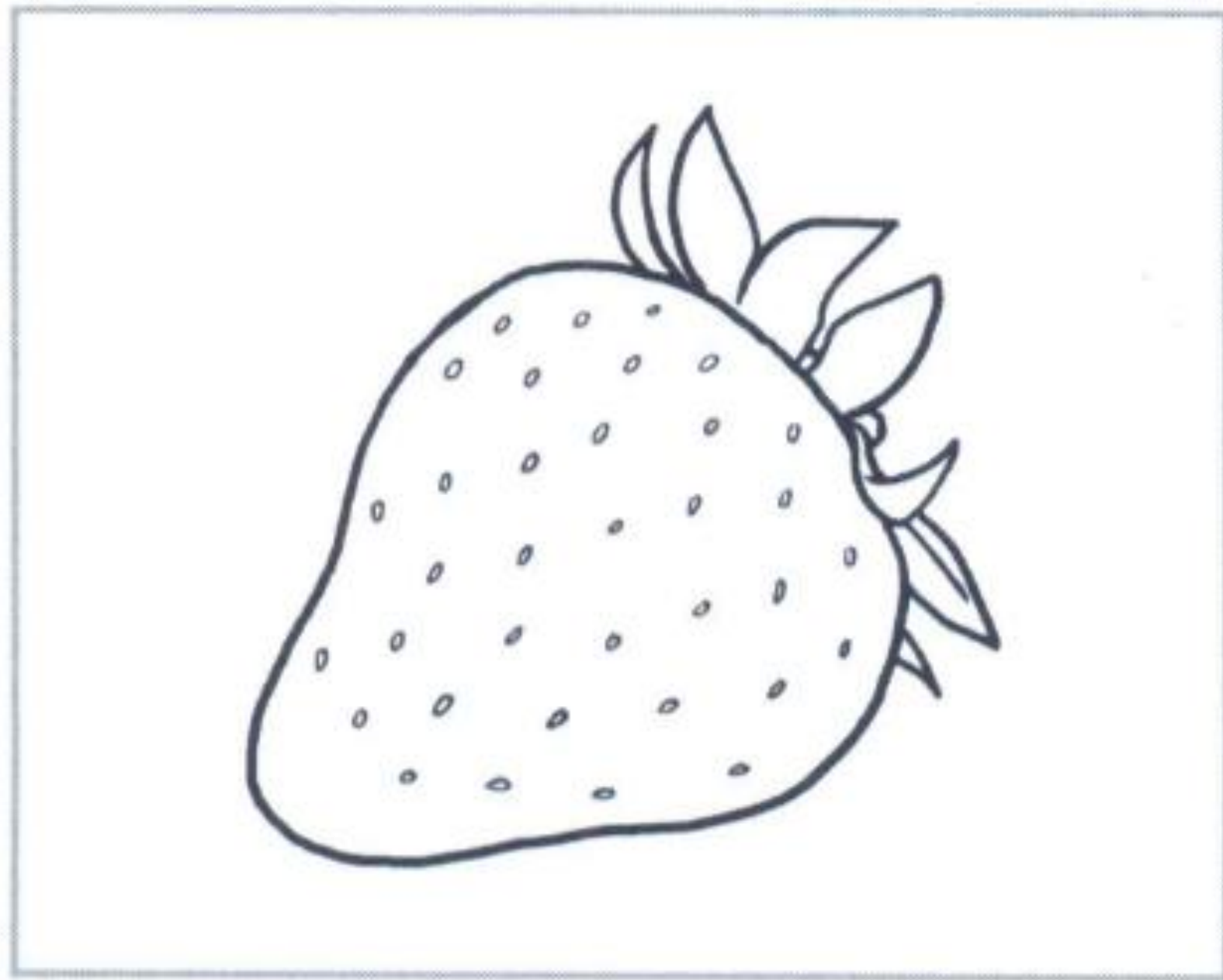

FRA LA

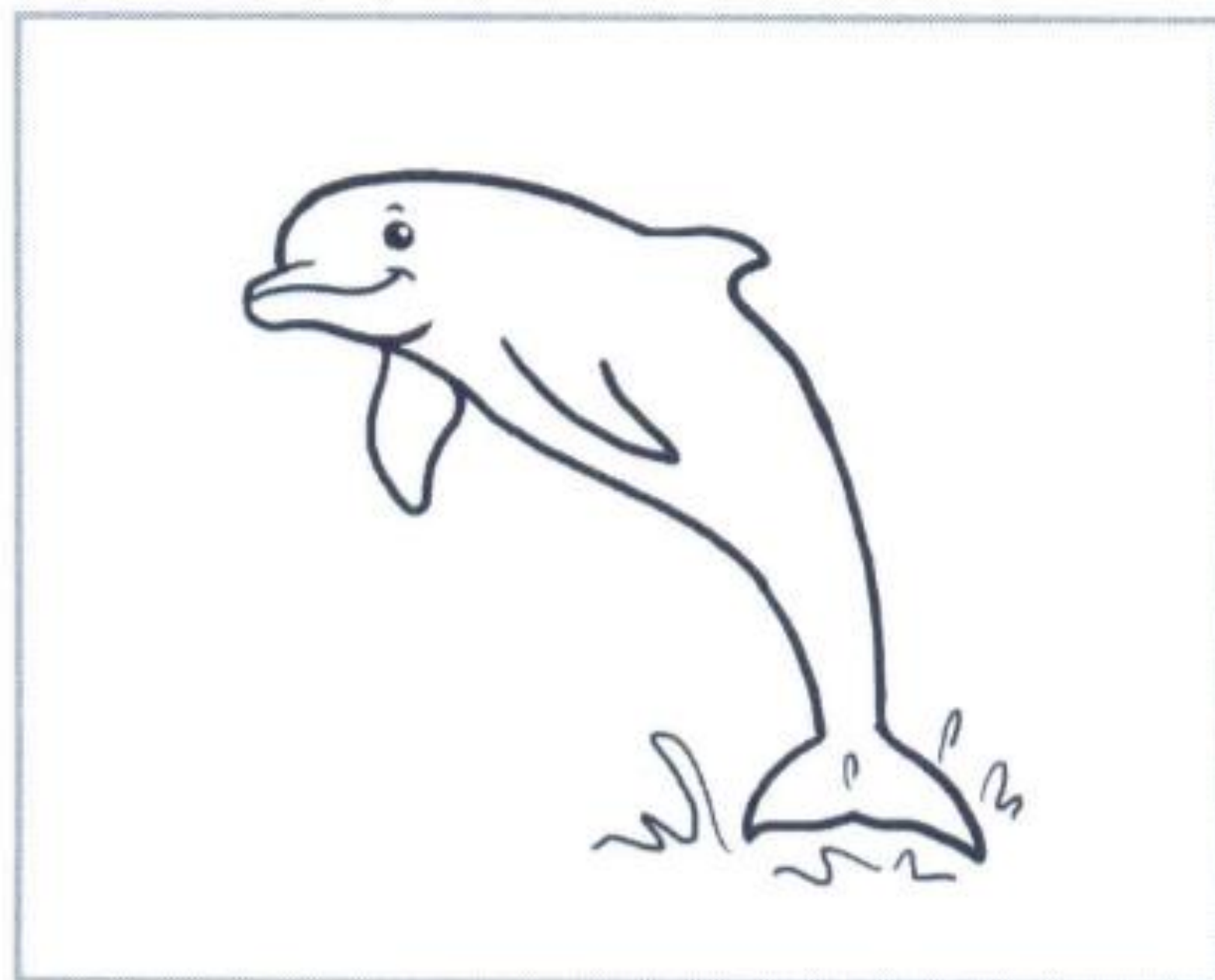

DEL FI



PA DA

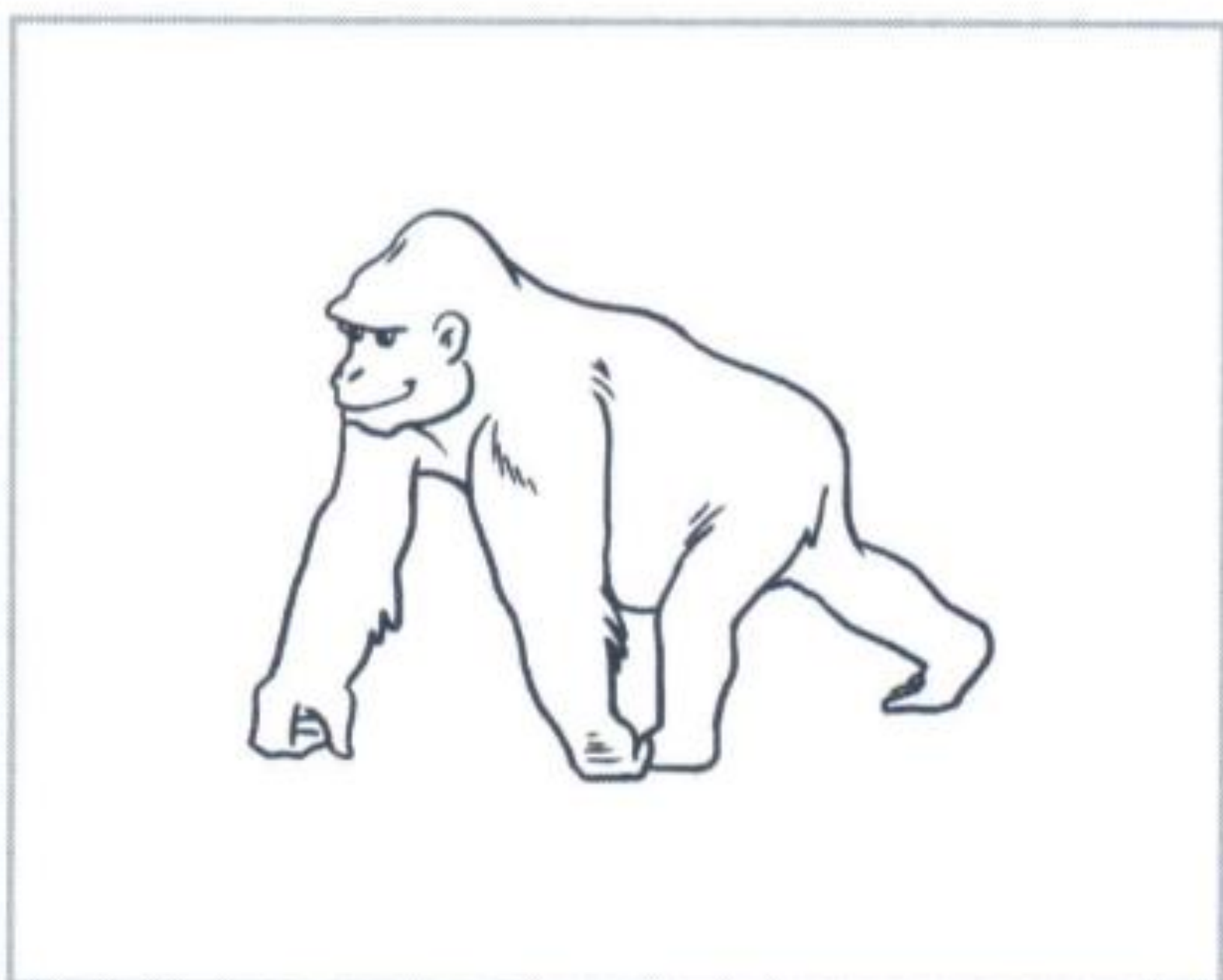

RIL LA

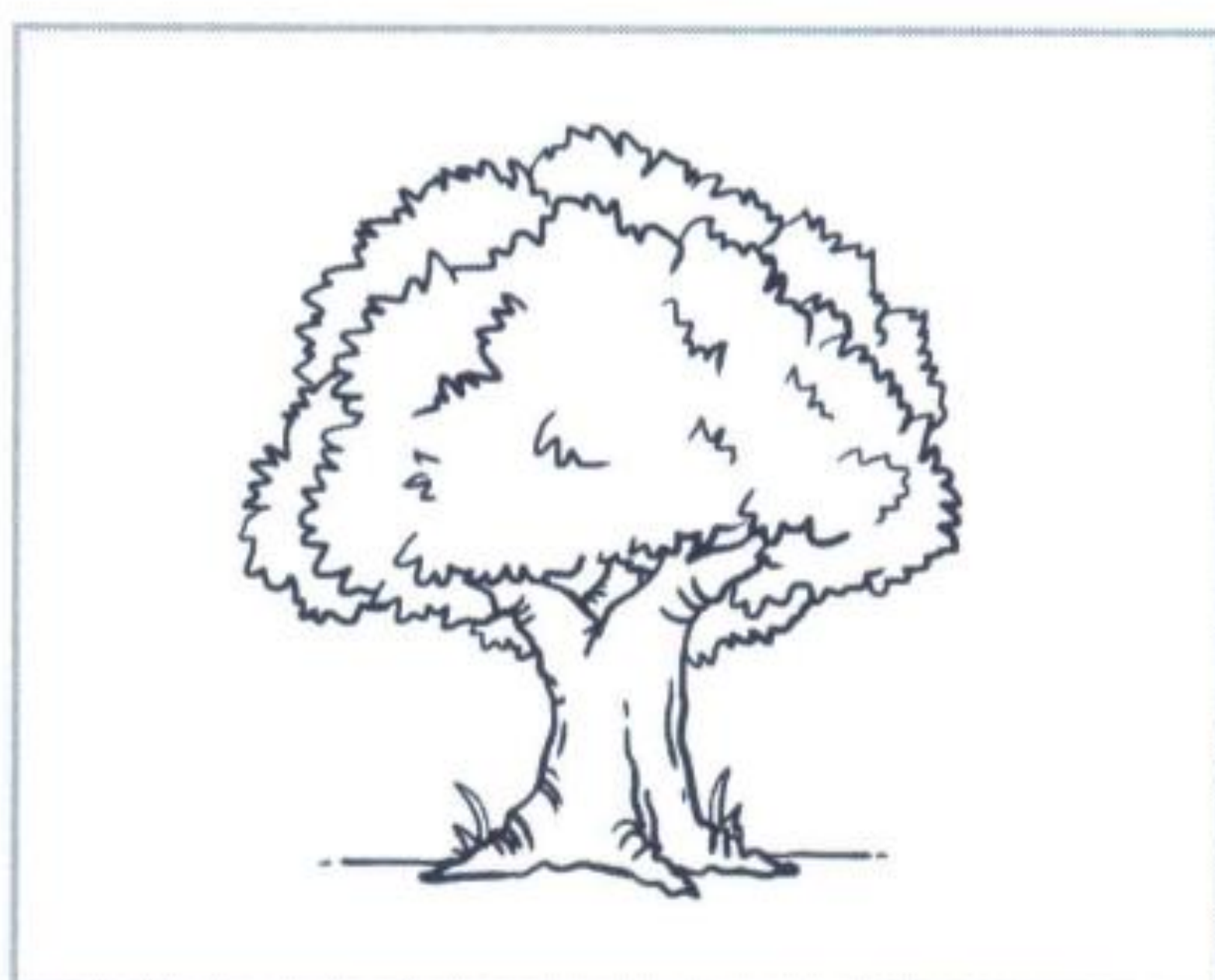

AL RO

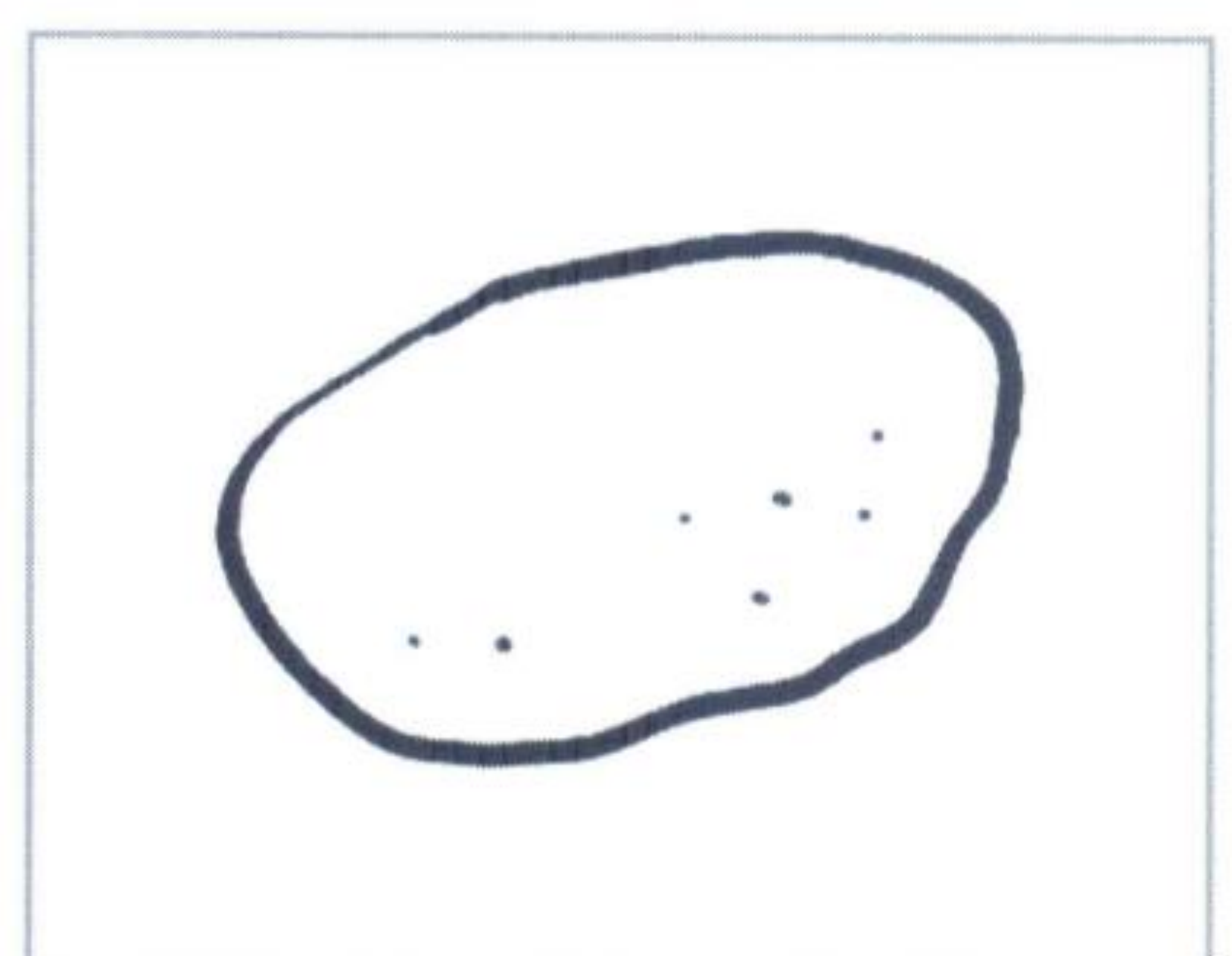

PA TA

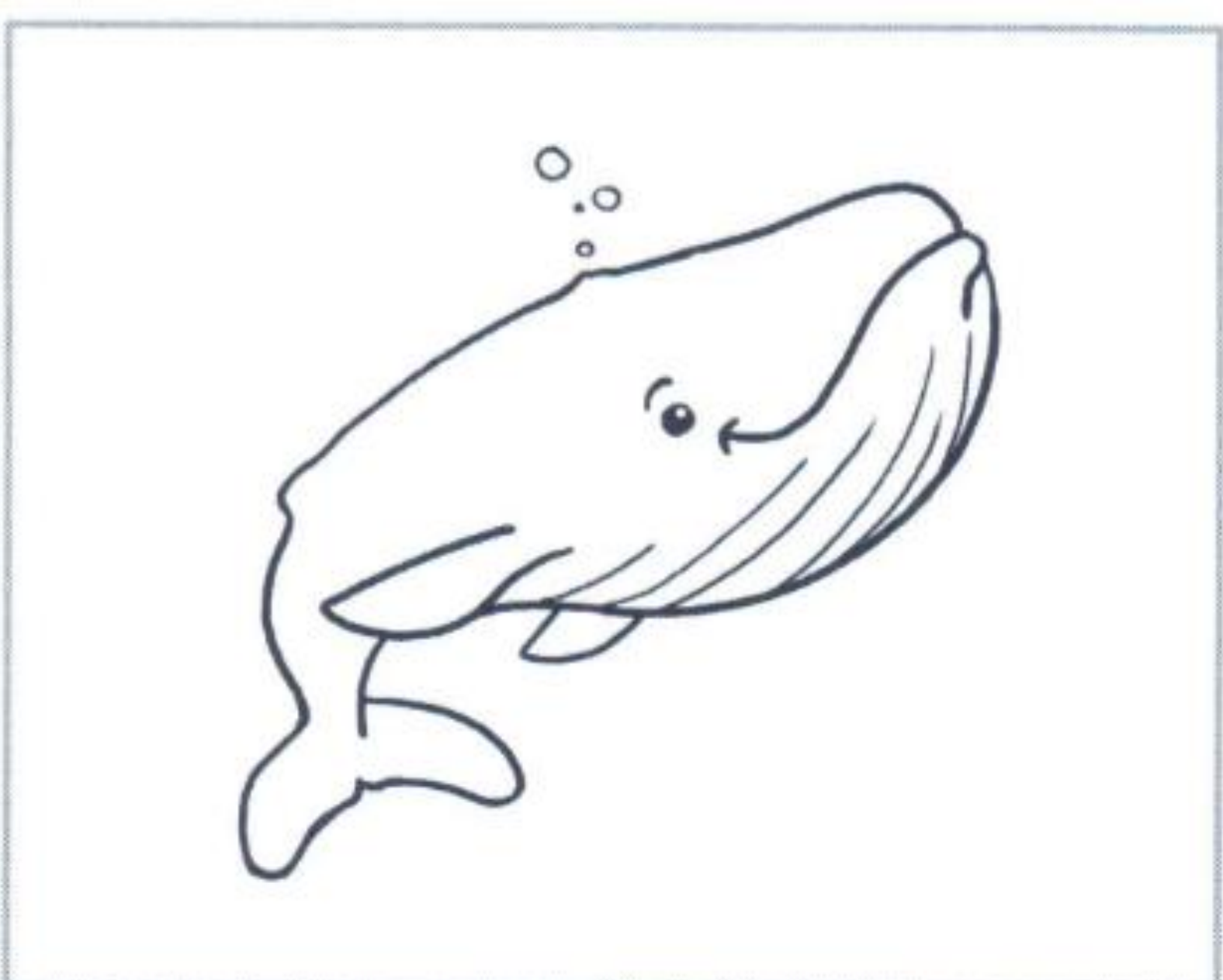

LE NA

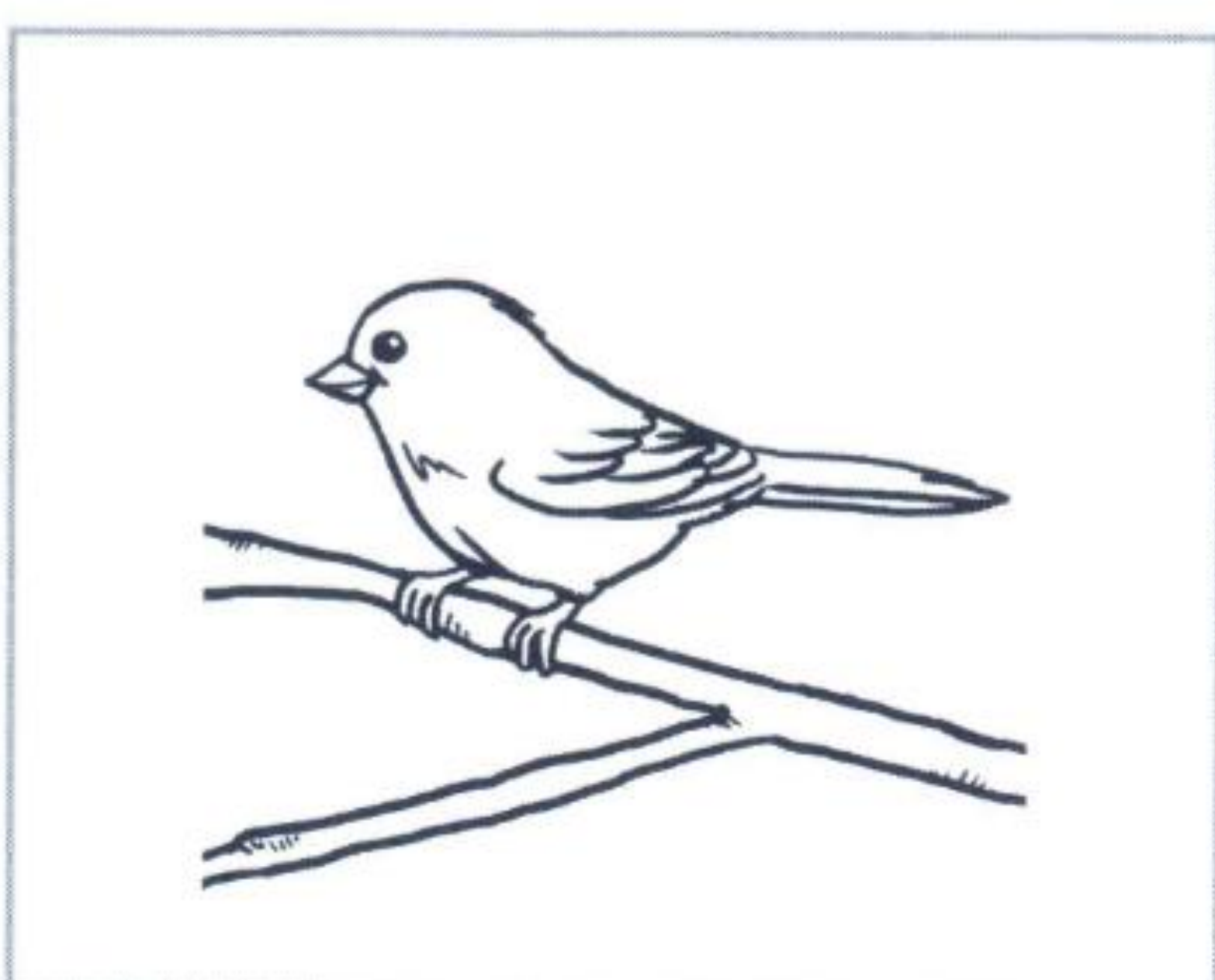

UC CEL

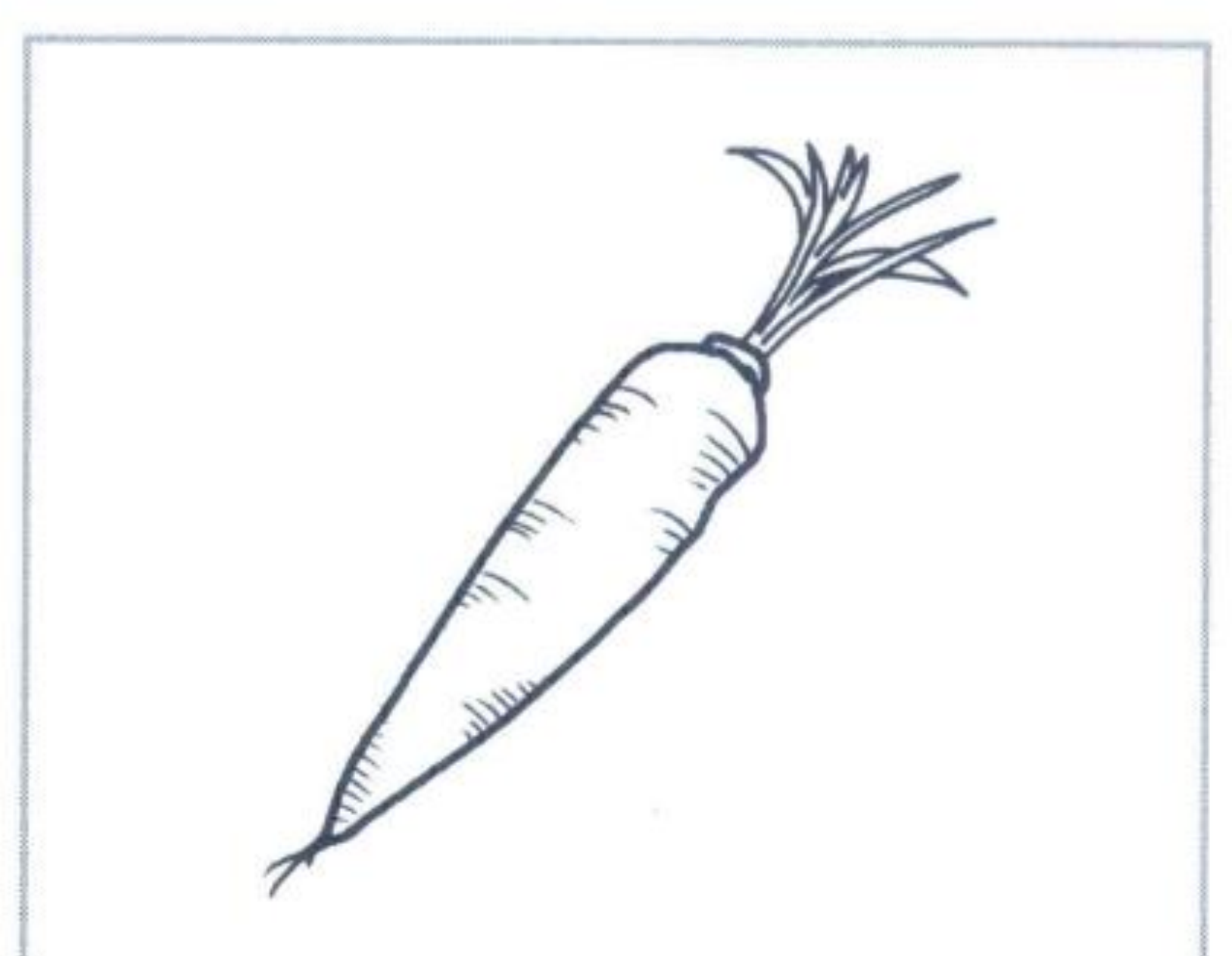

CA TA

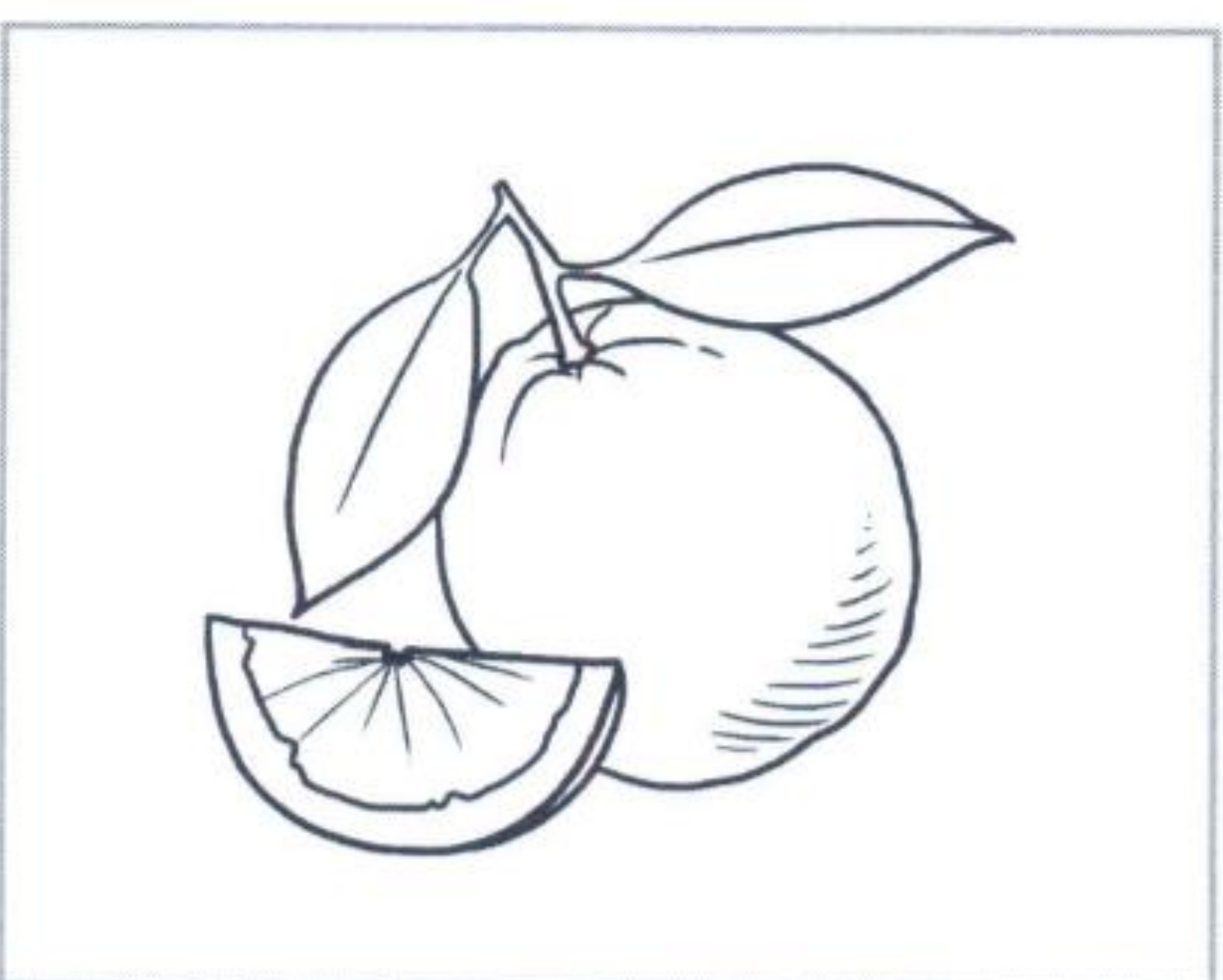

RAN CIA

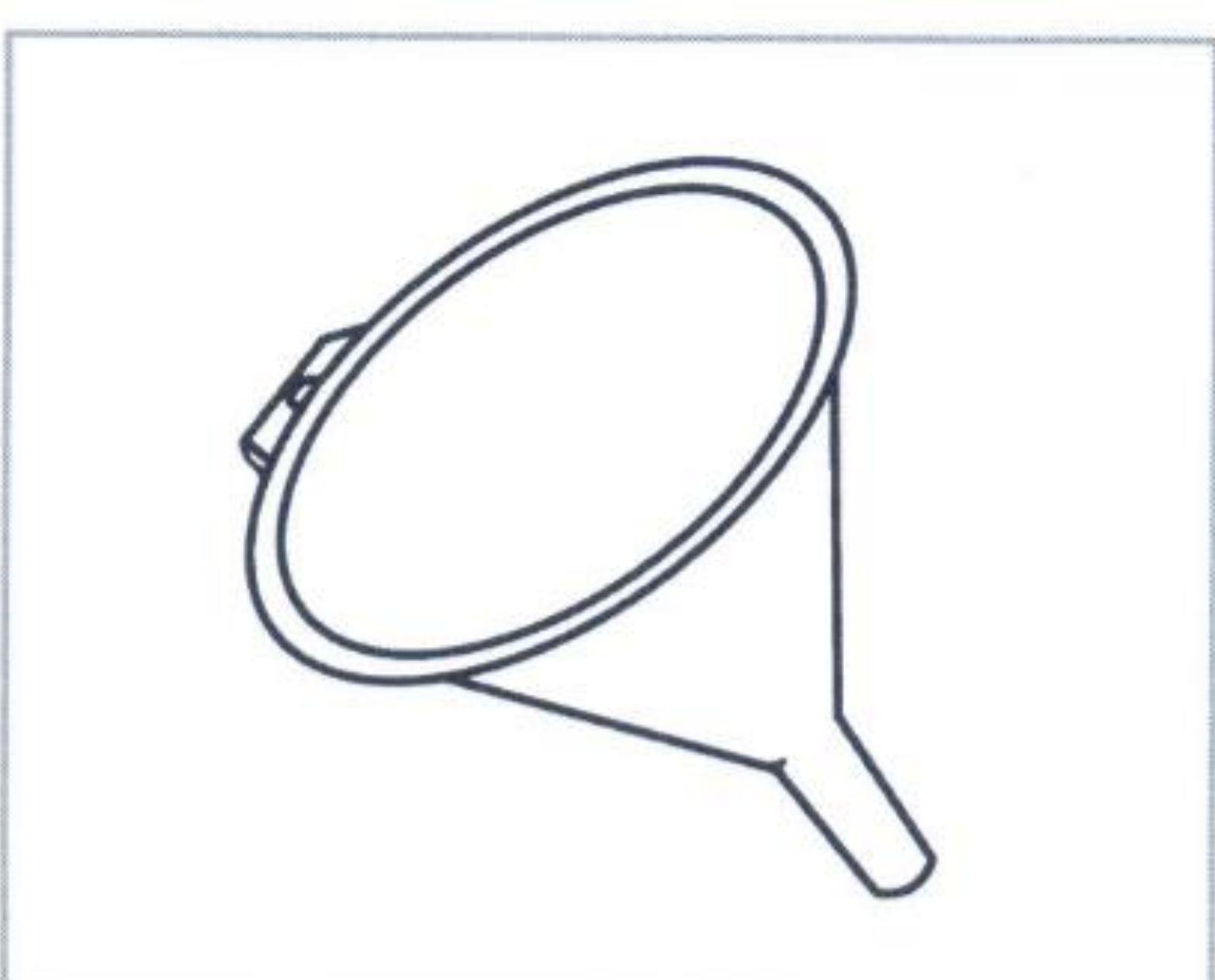

IM TO



BREL LO

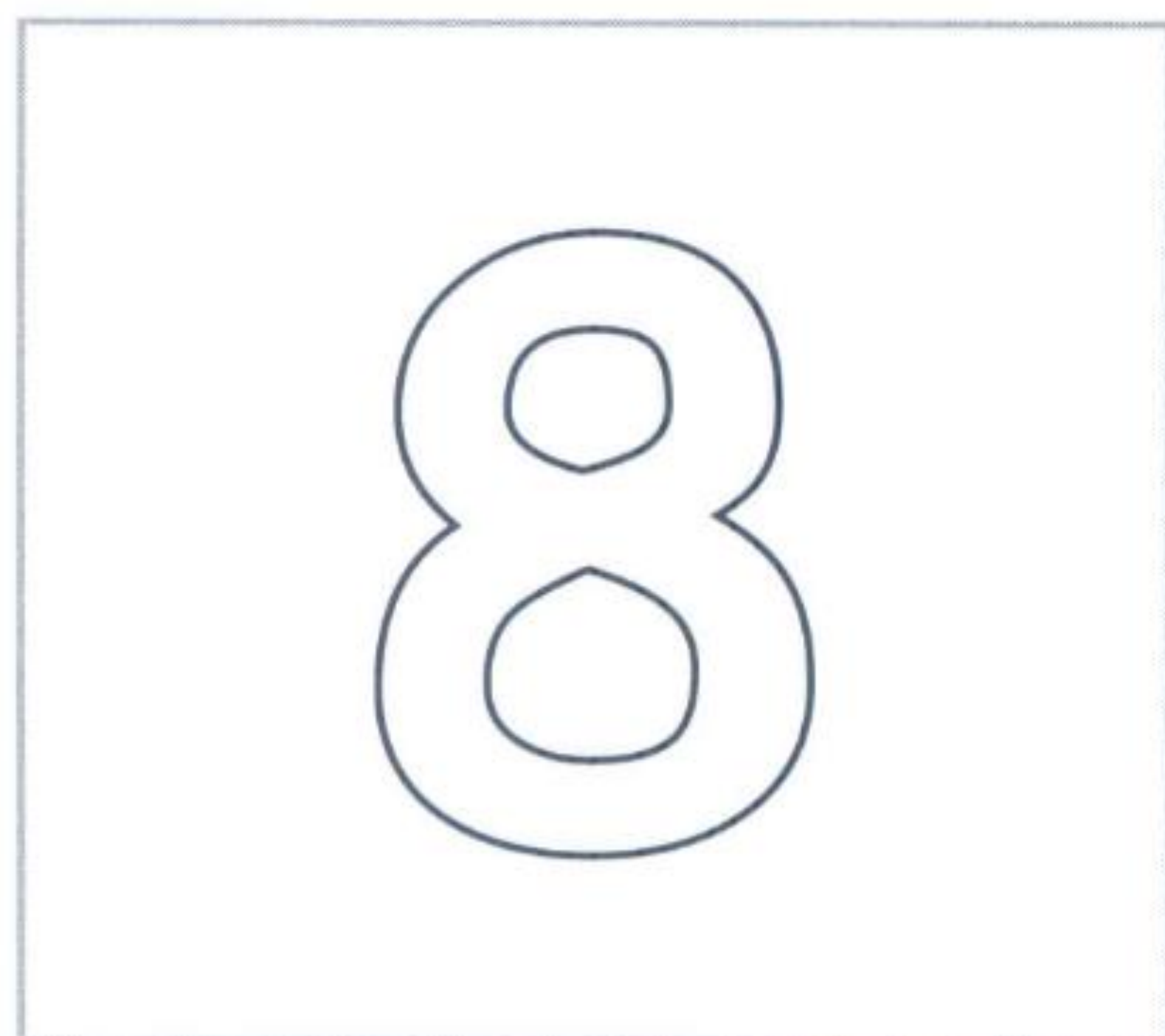

TO OT

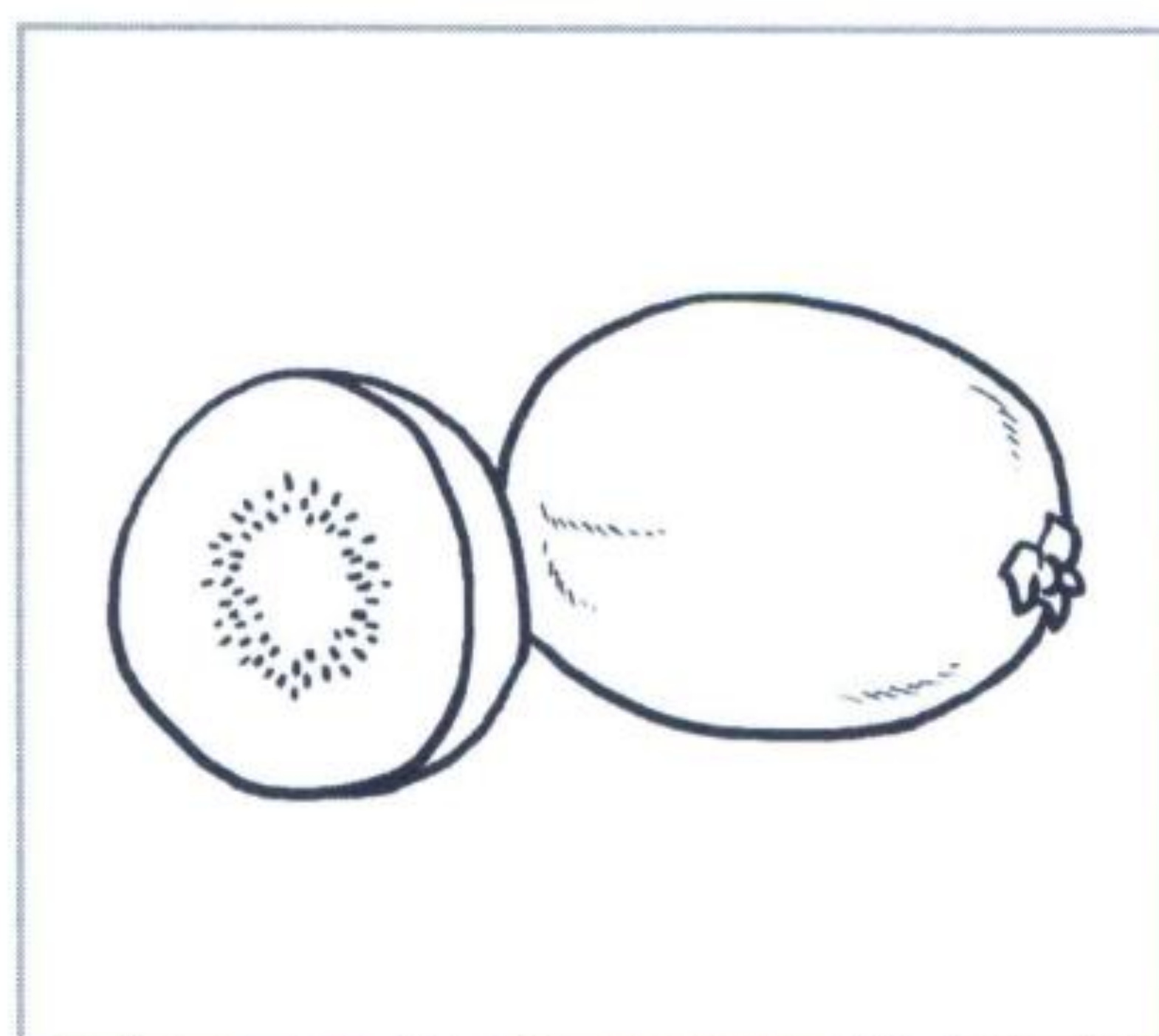

WI KI

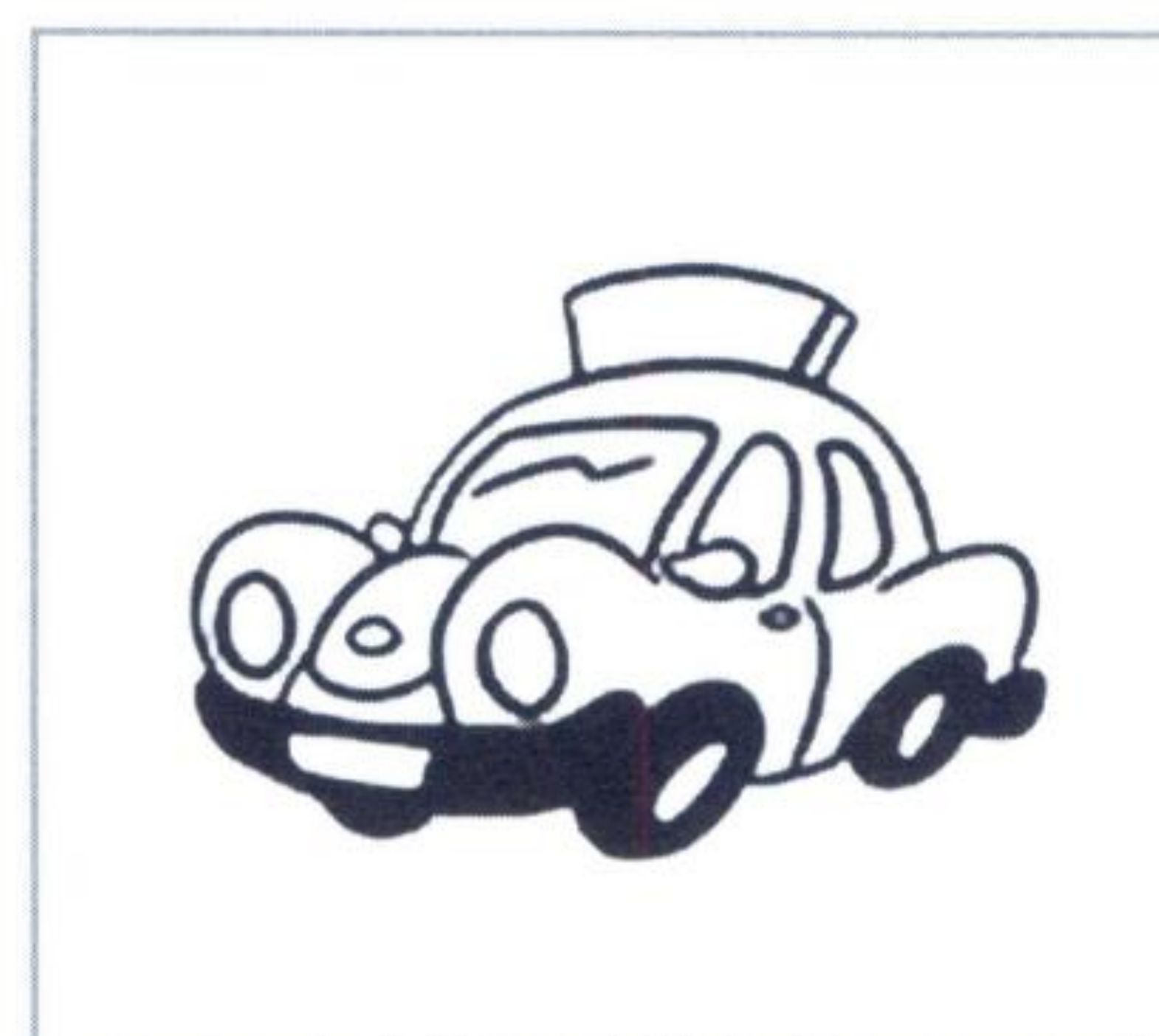

XI TA

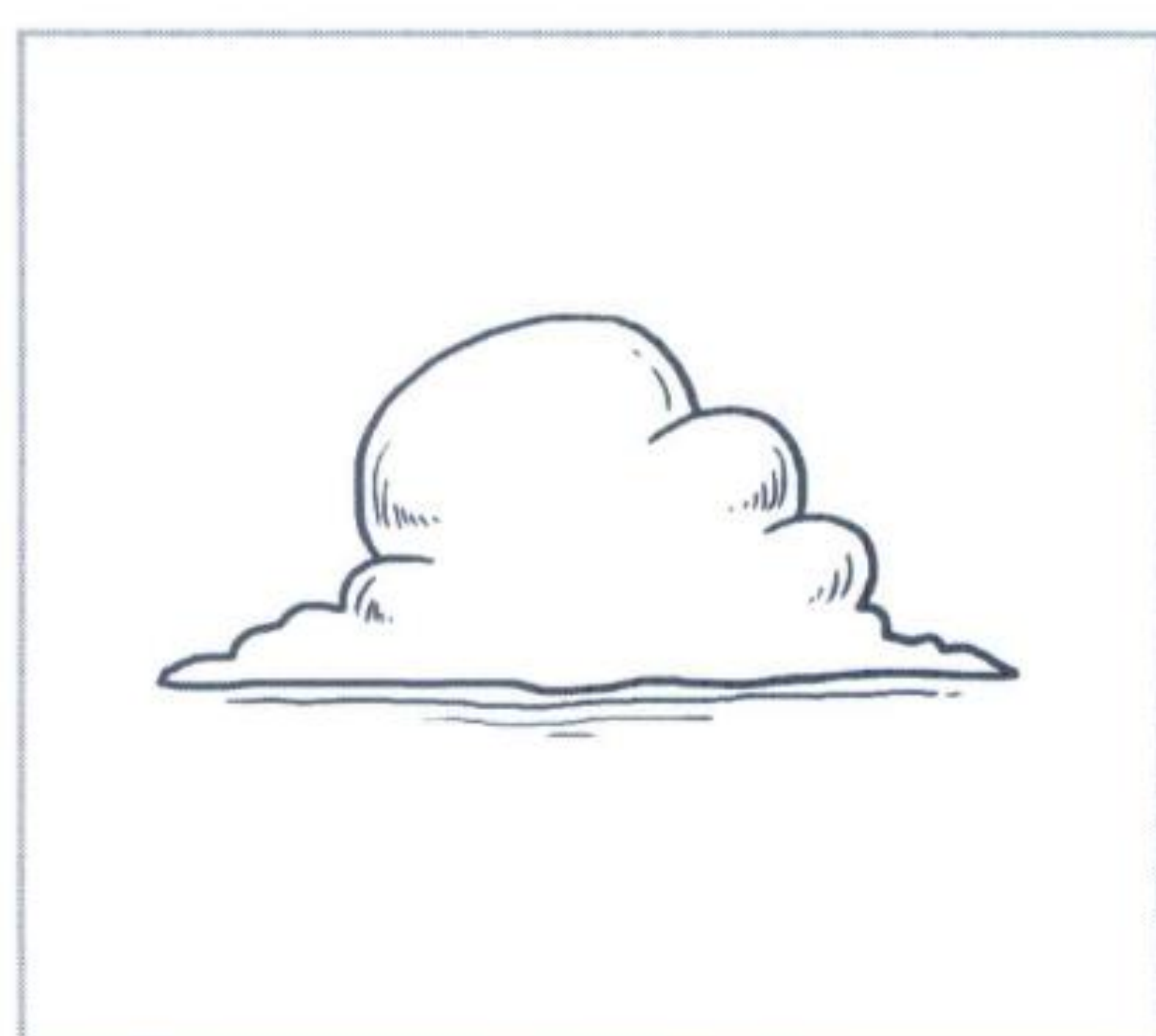
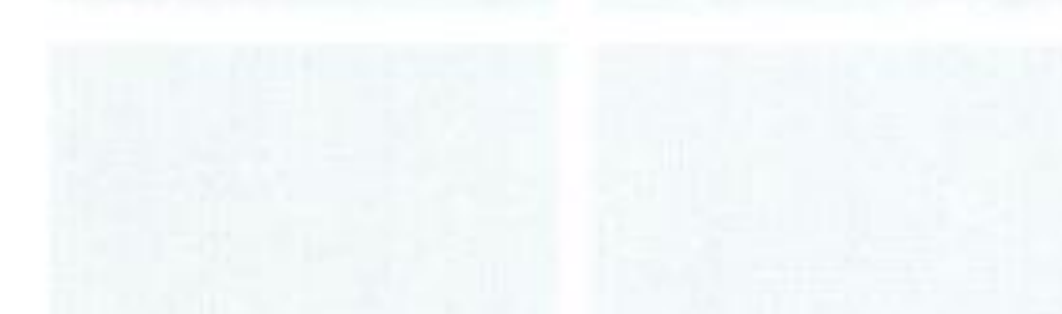

BE NU



DI SOL

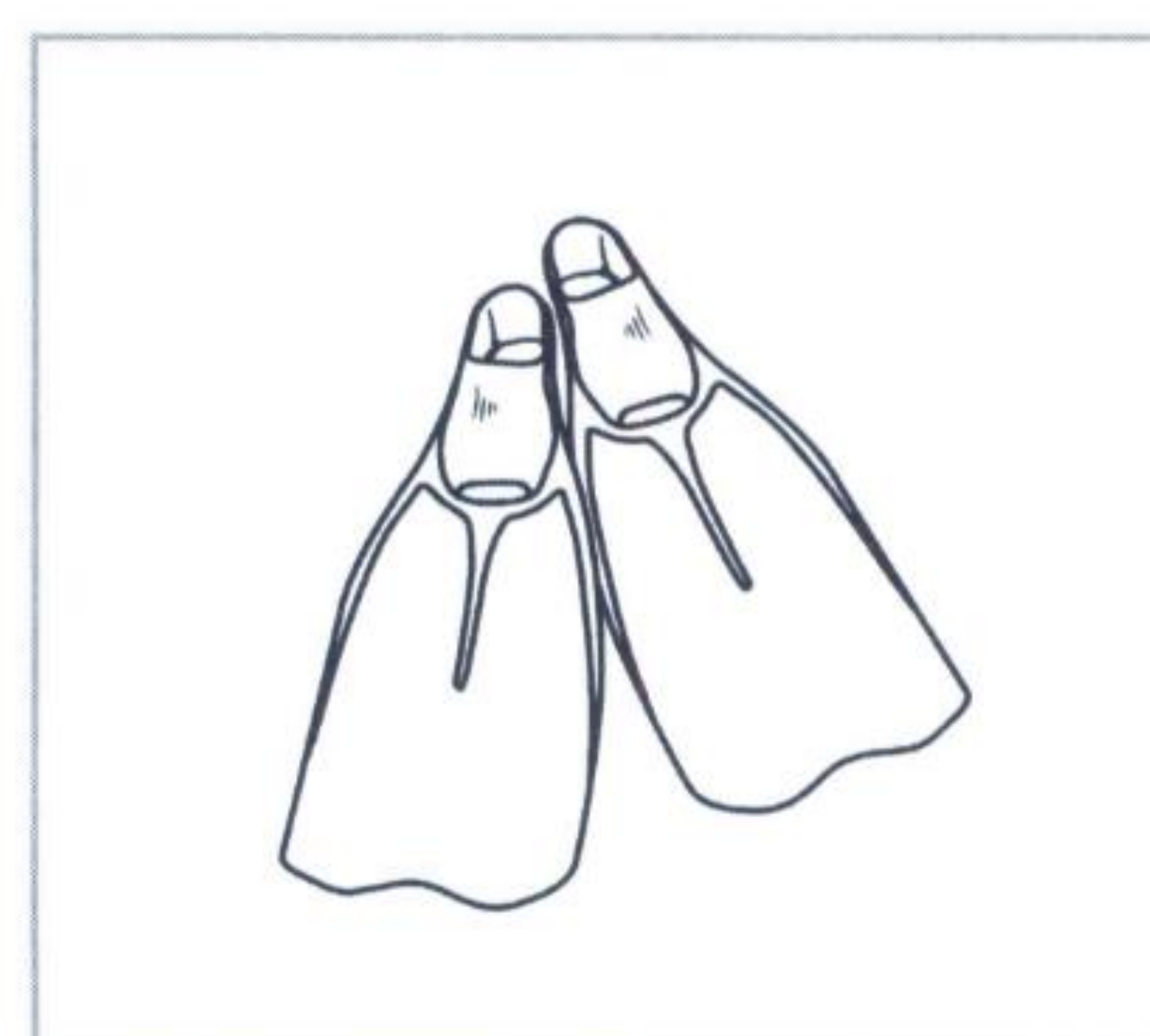

NE PIN

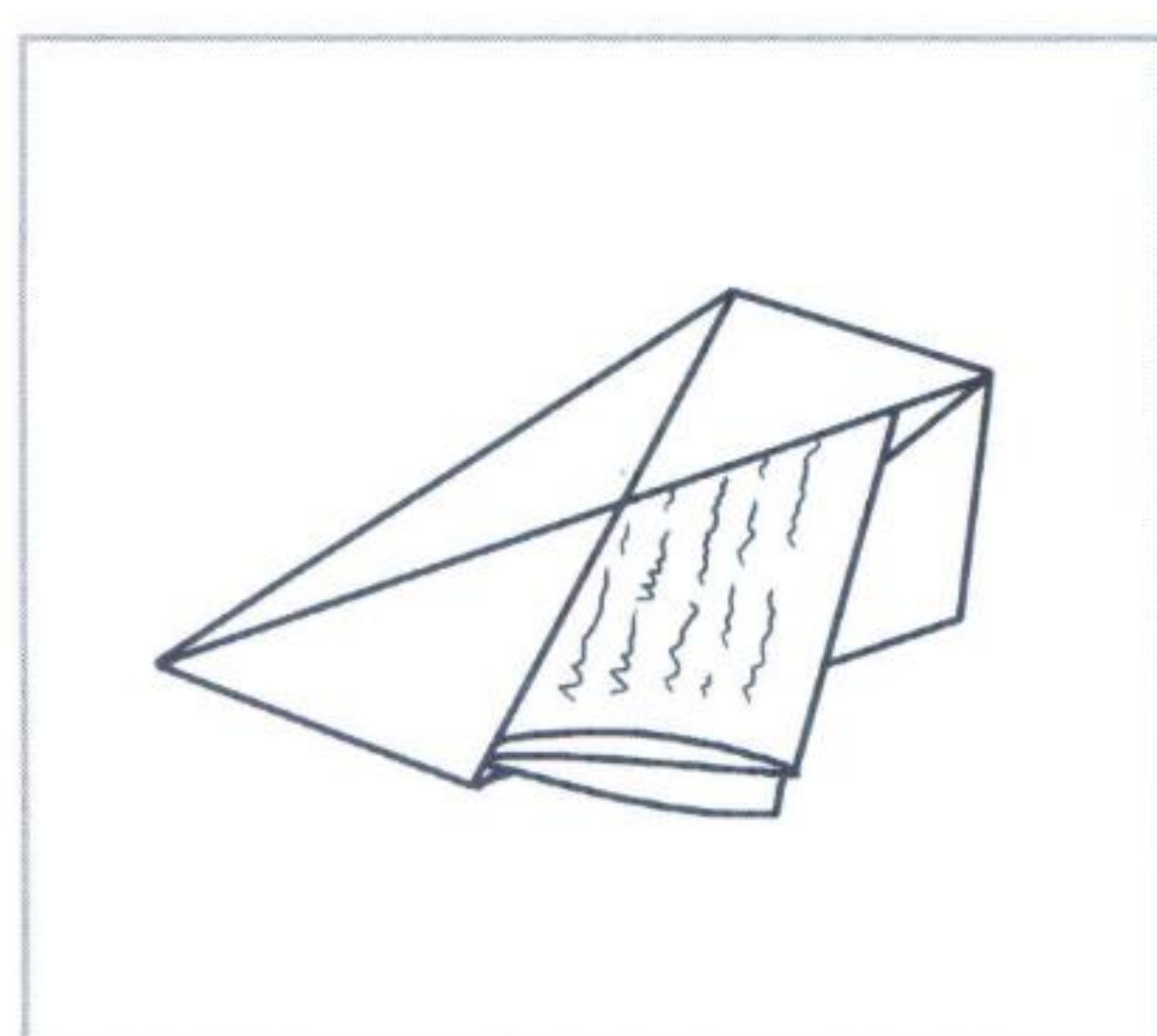
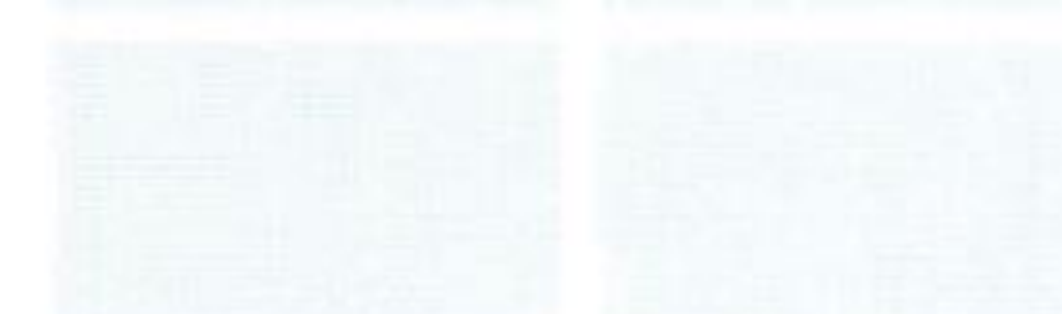

STA BU

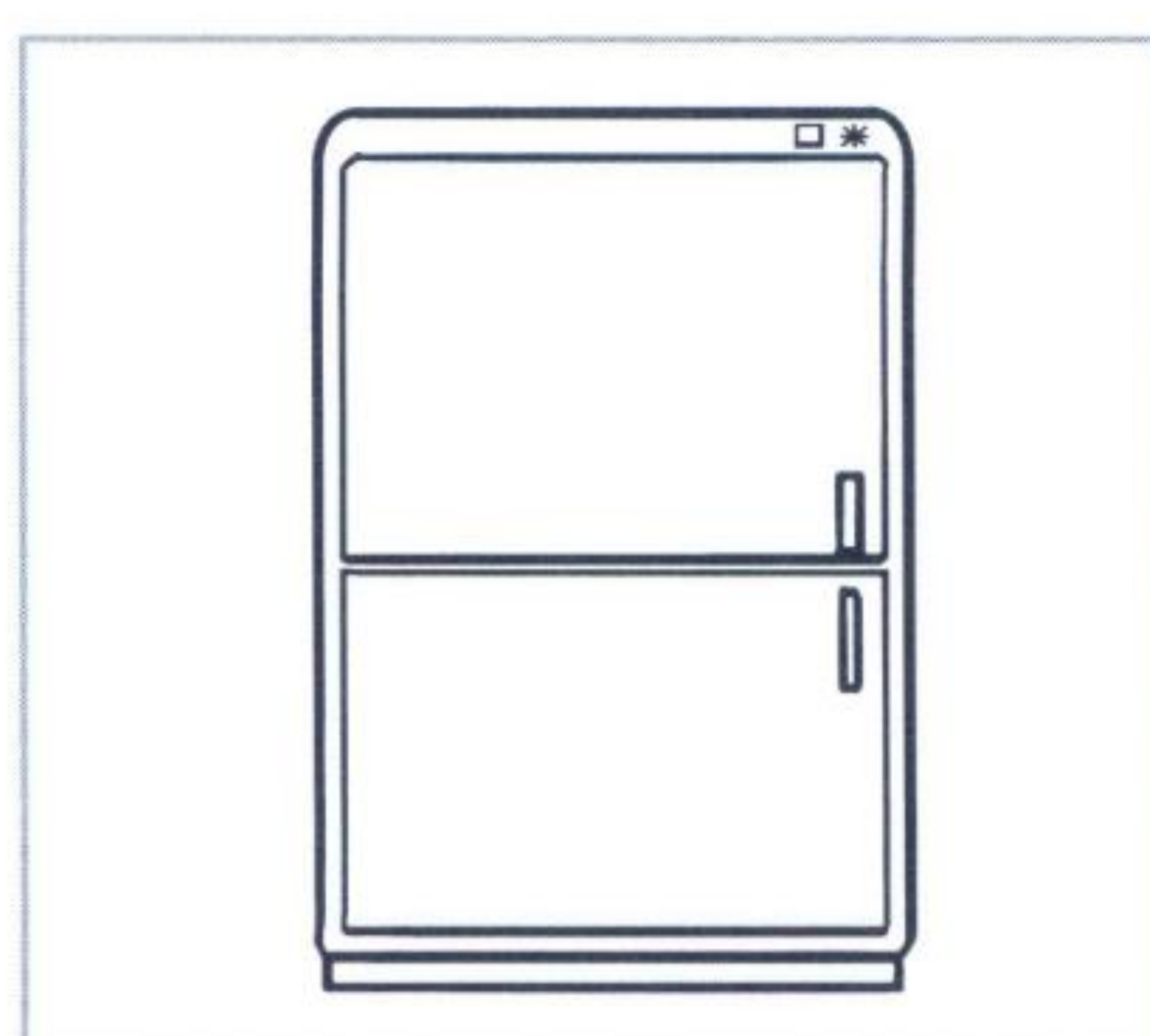

GO FRI

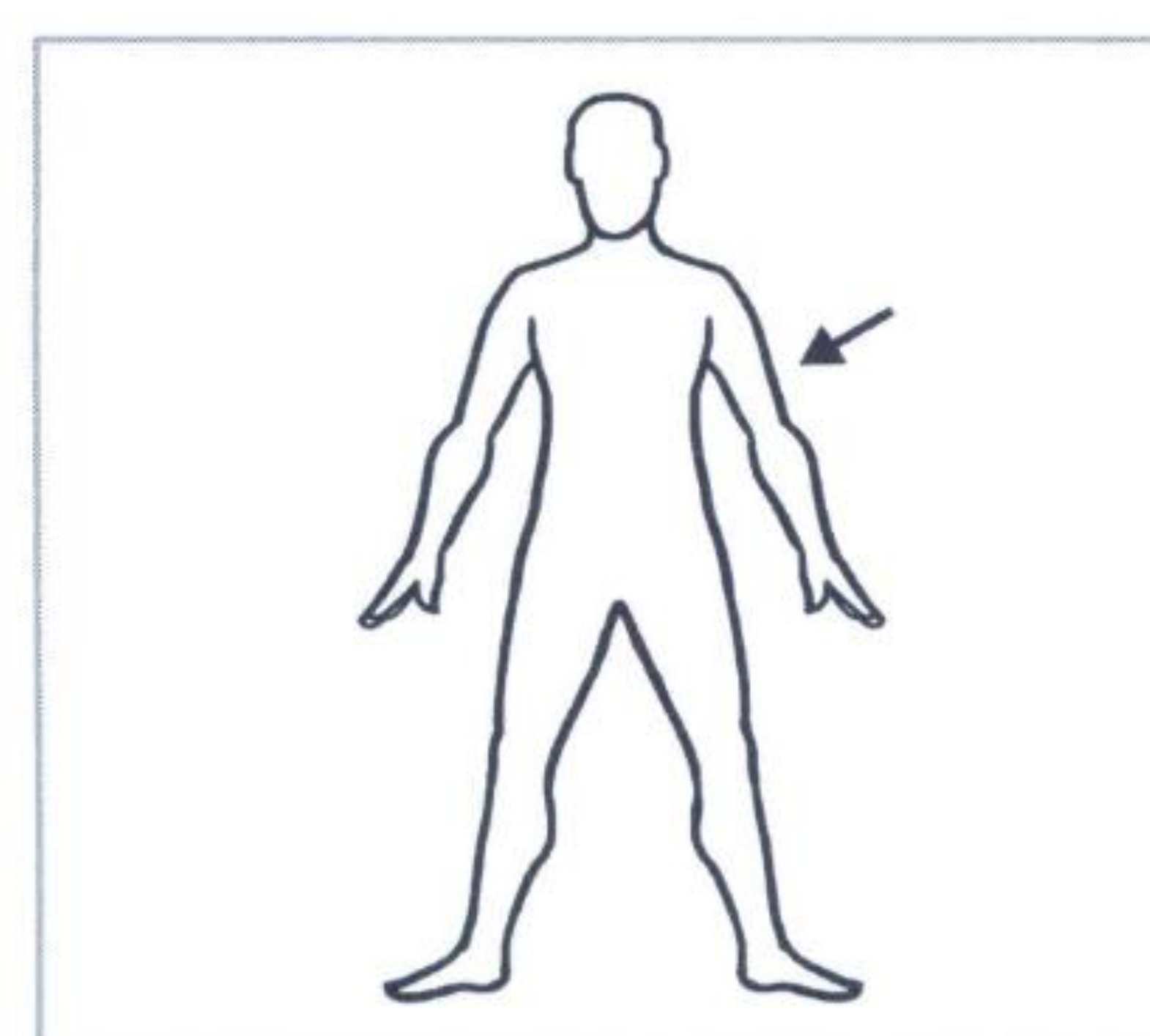

CIO BRAC





RIORDINA LE SILLABE IN MODO DA FORMARE
LA PAROLA CORRISPONDENTE AL DISEGNO

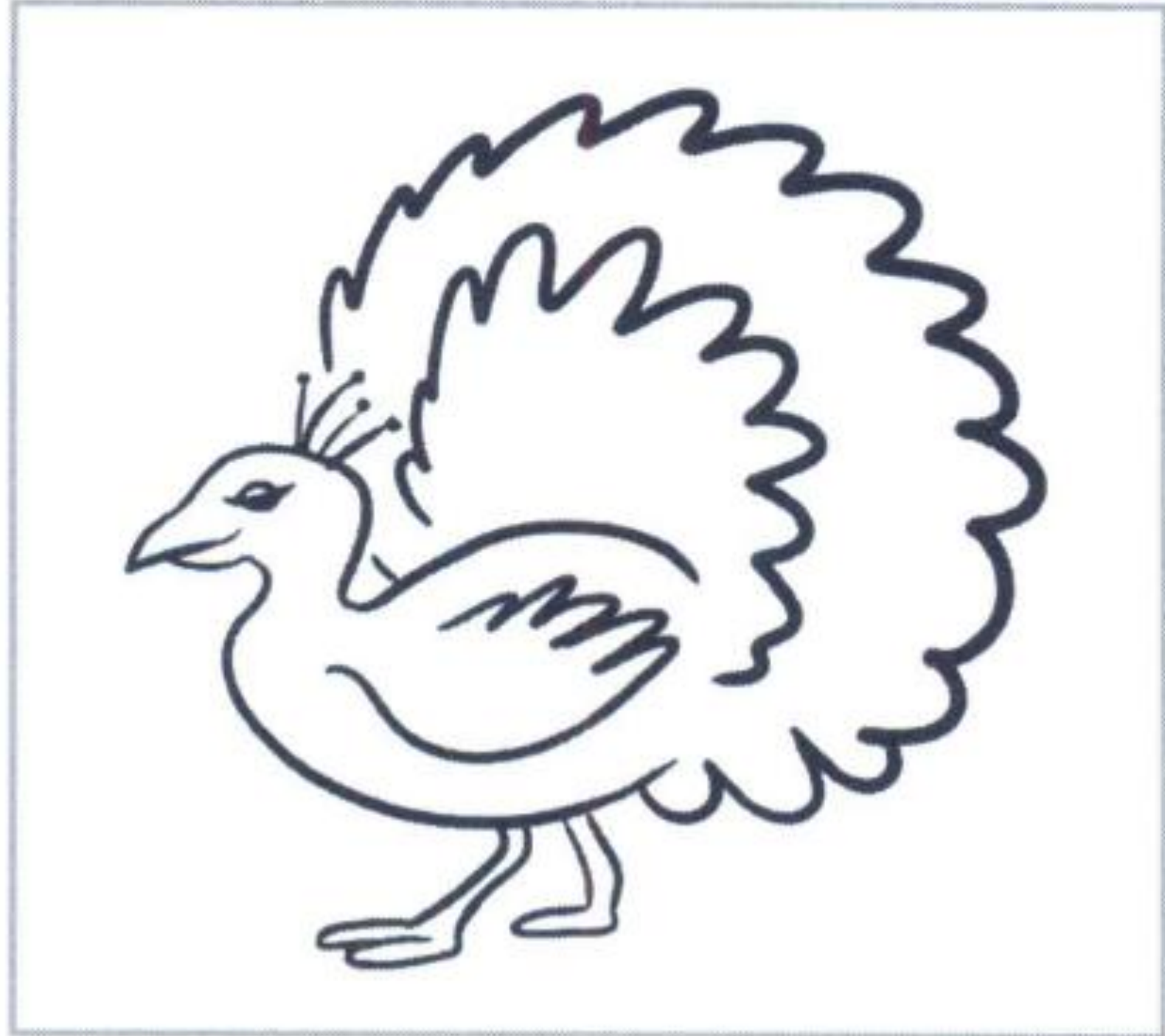

NE PA VO

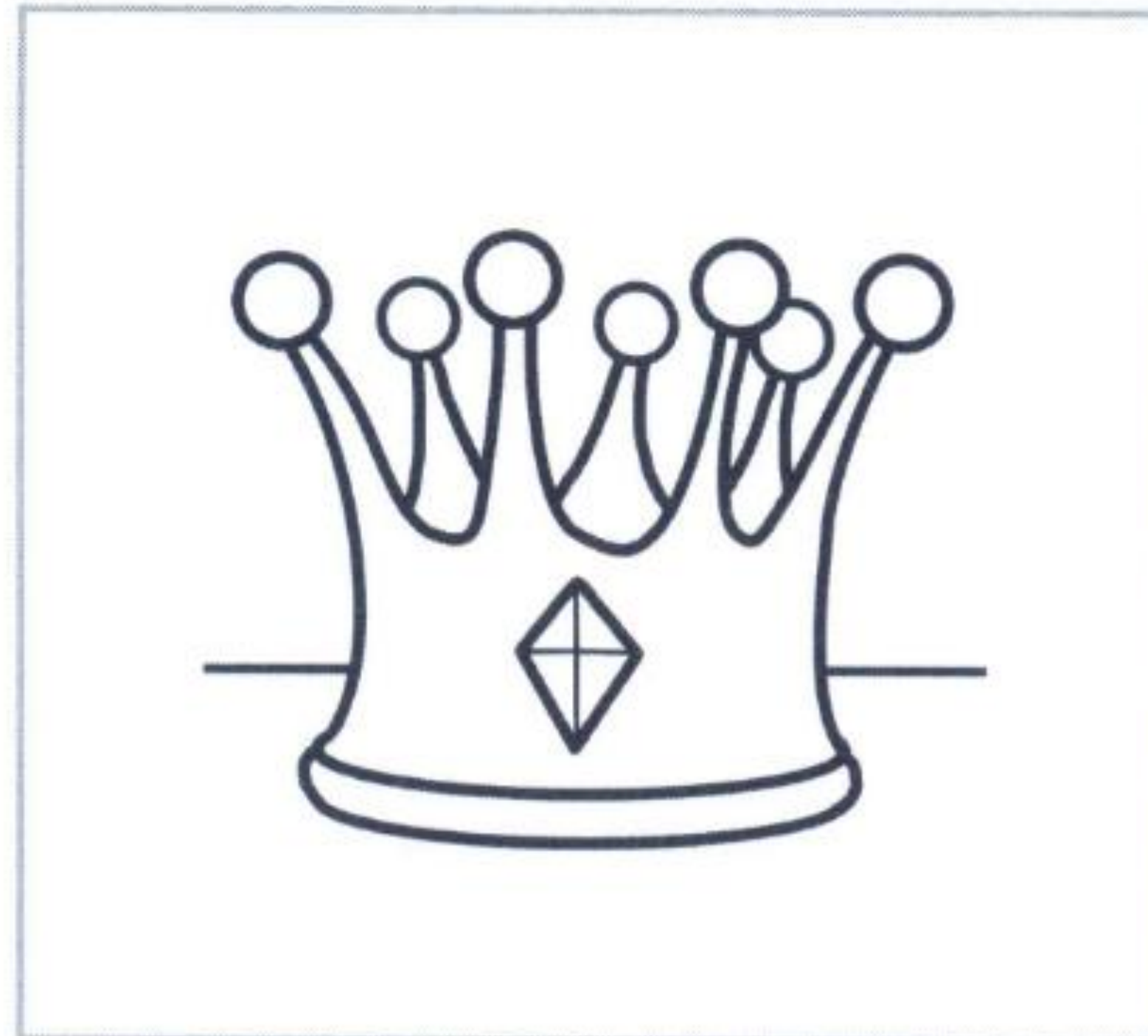

RO NA CO

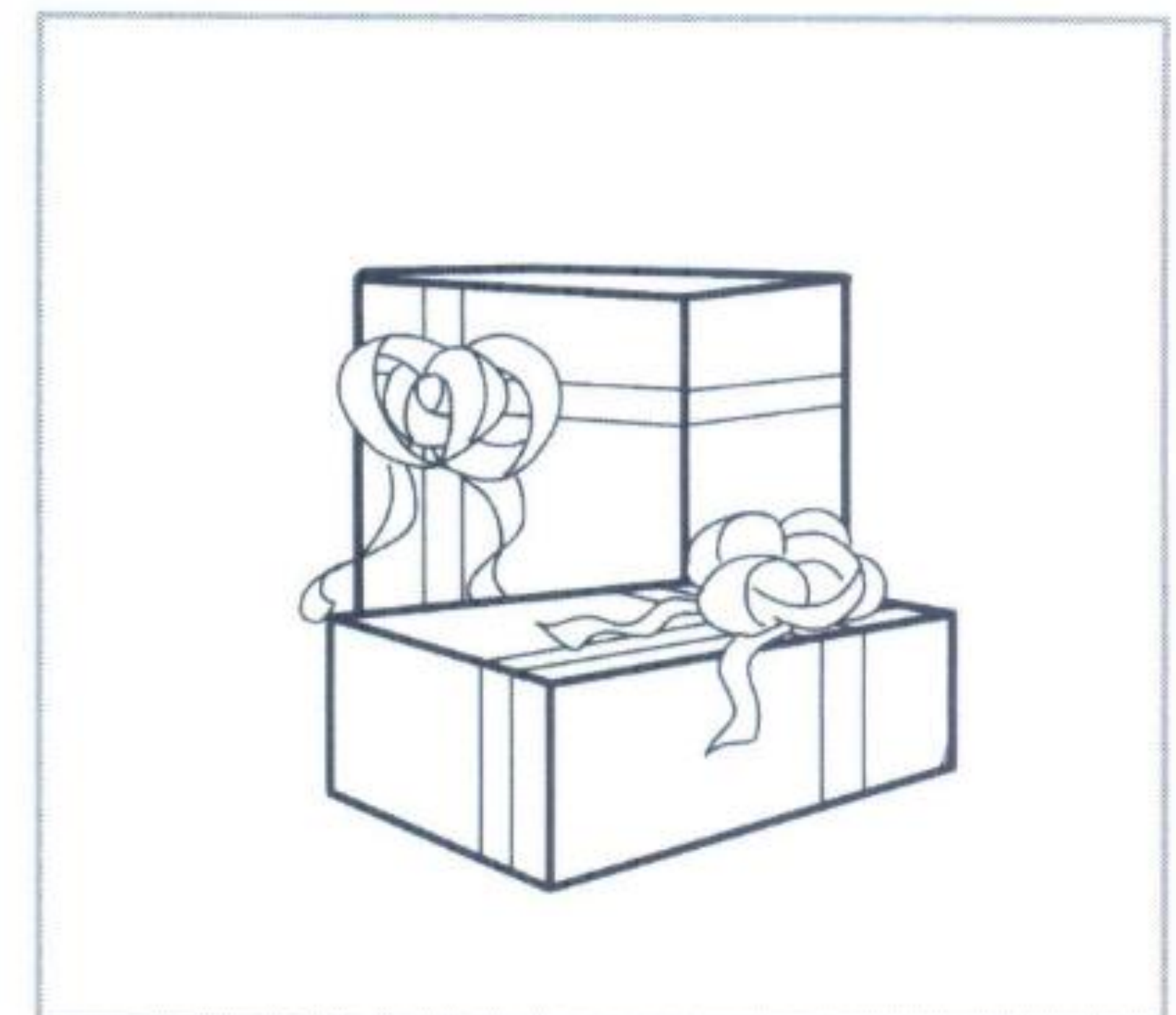

LI GA RE



OM LO BREL

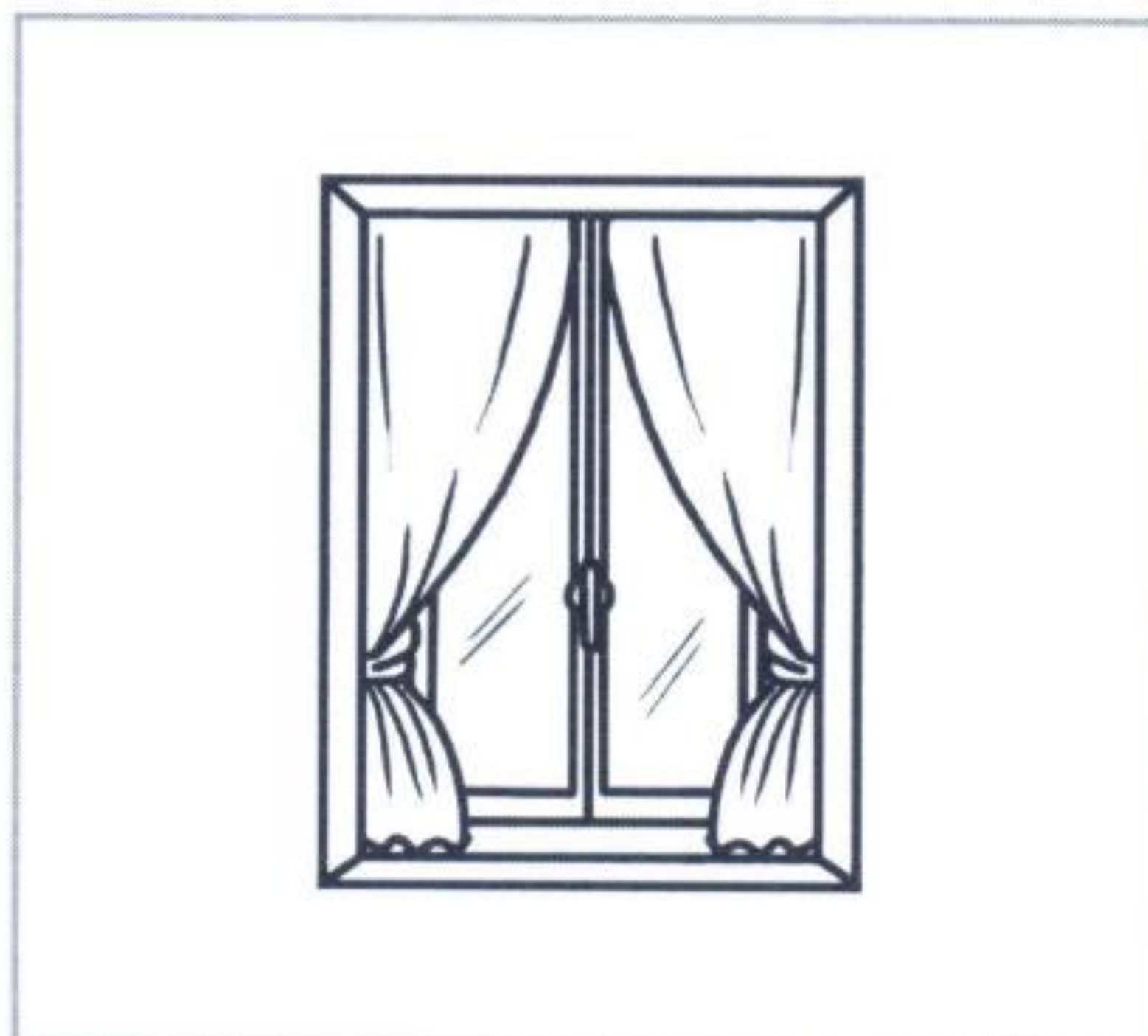

STRA FI NE

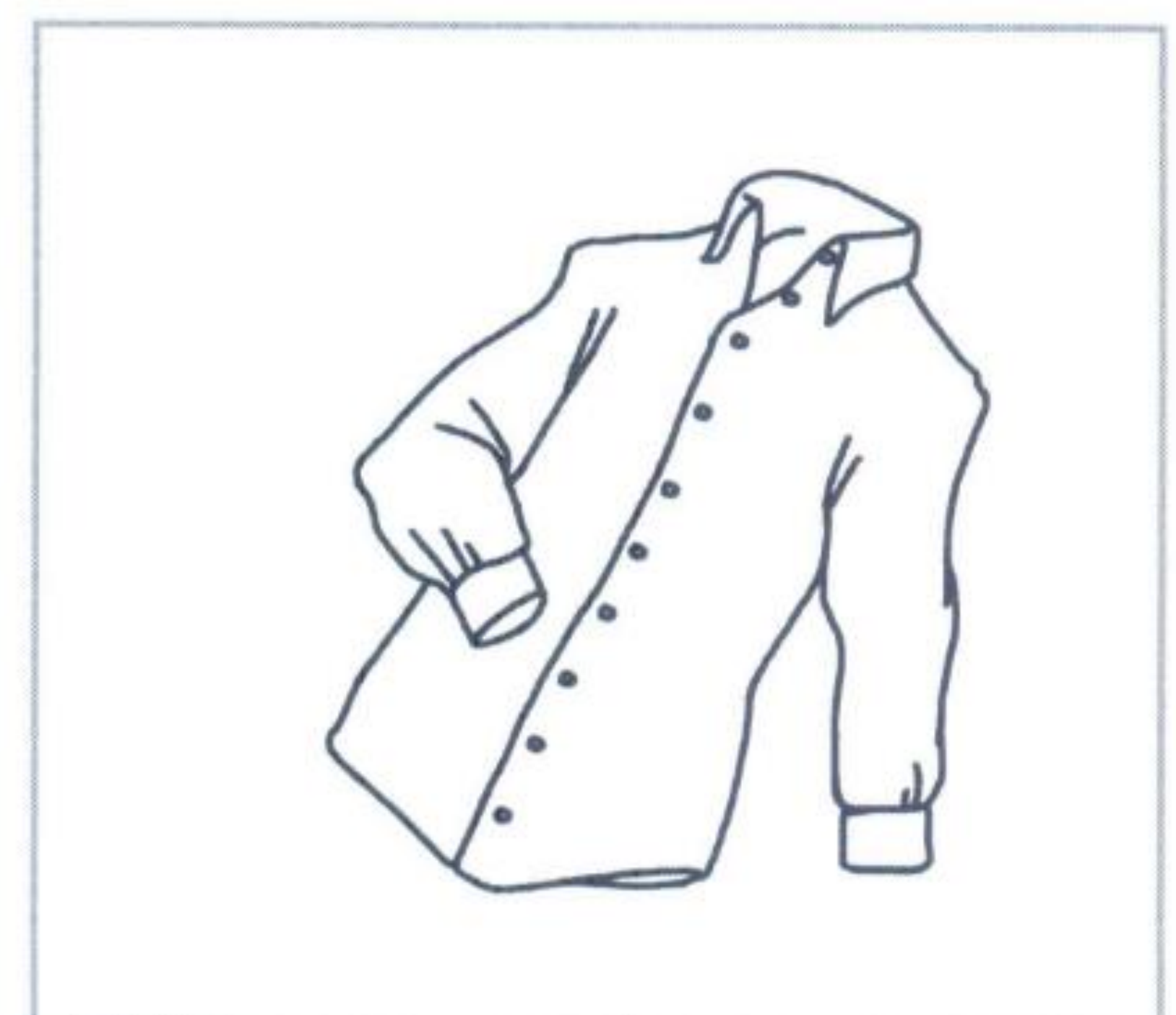

CIA CA MI

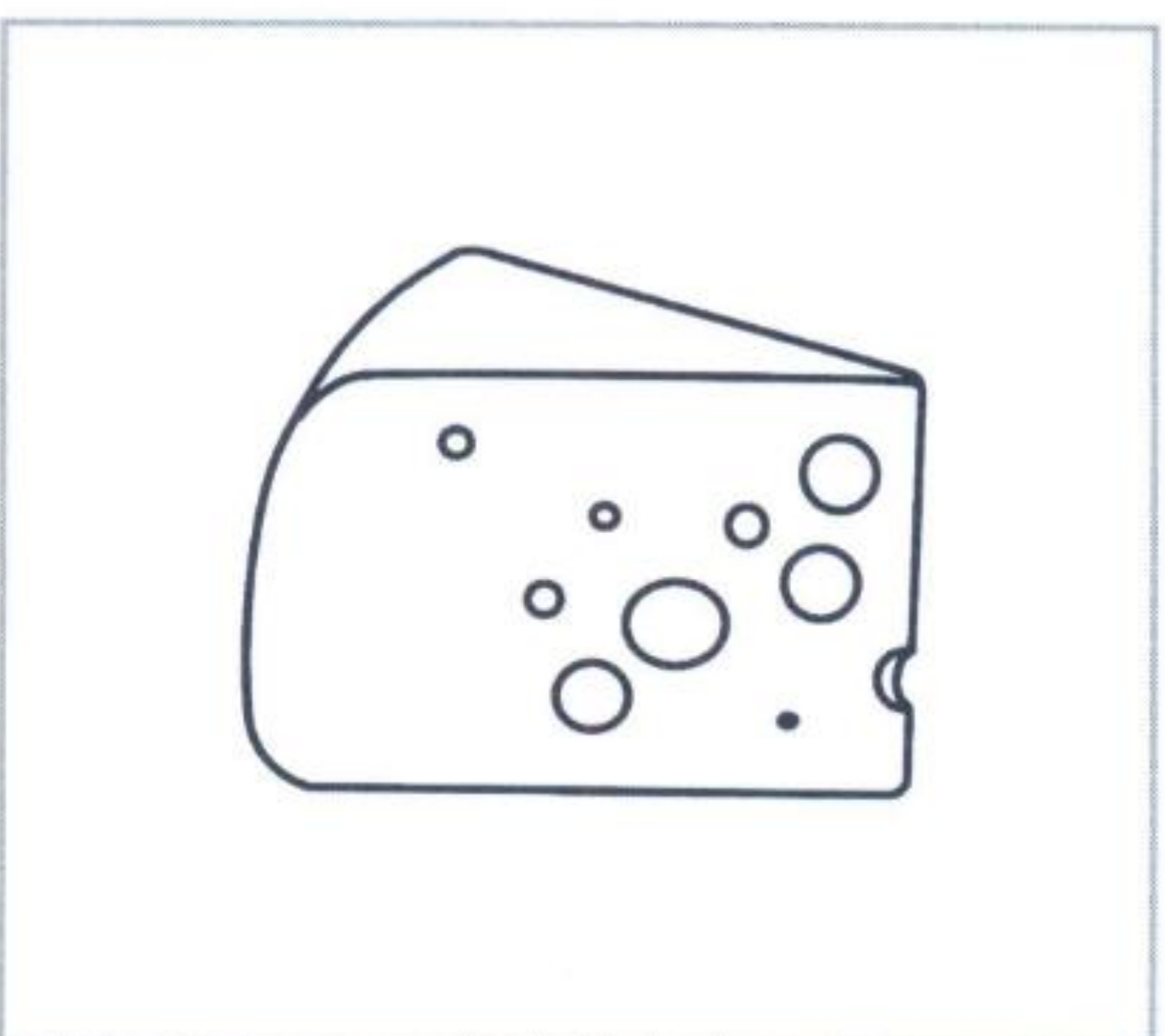

MAG FOR GIO



SCOT BI TI

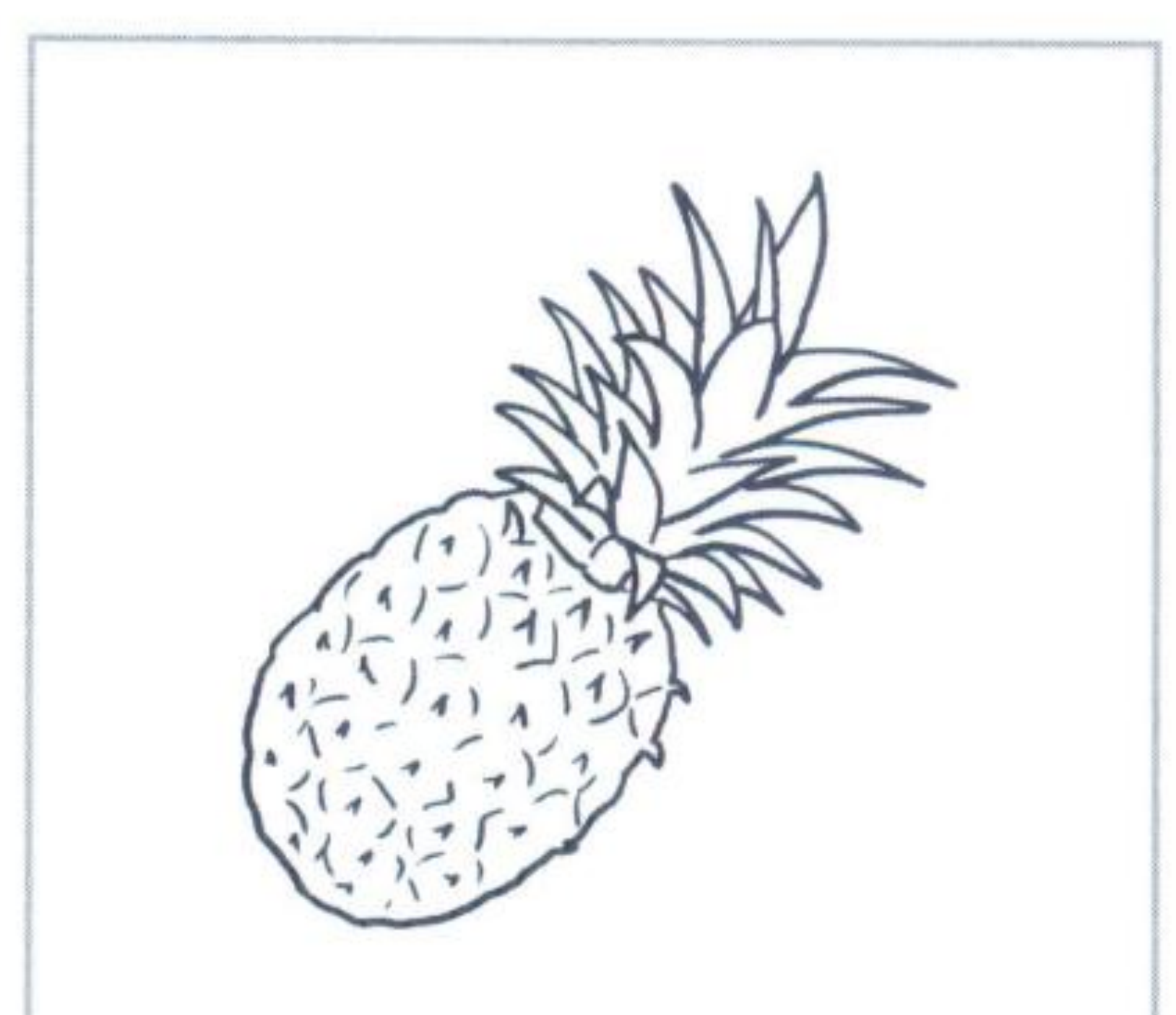

NA NAS A

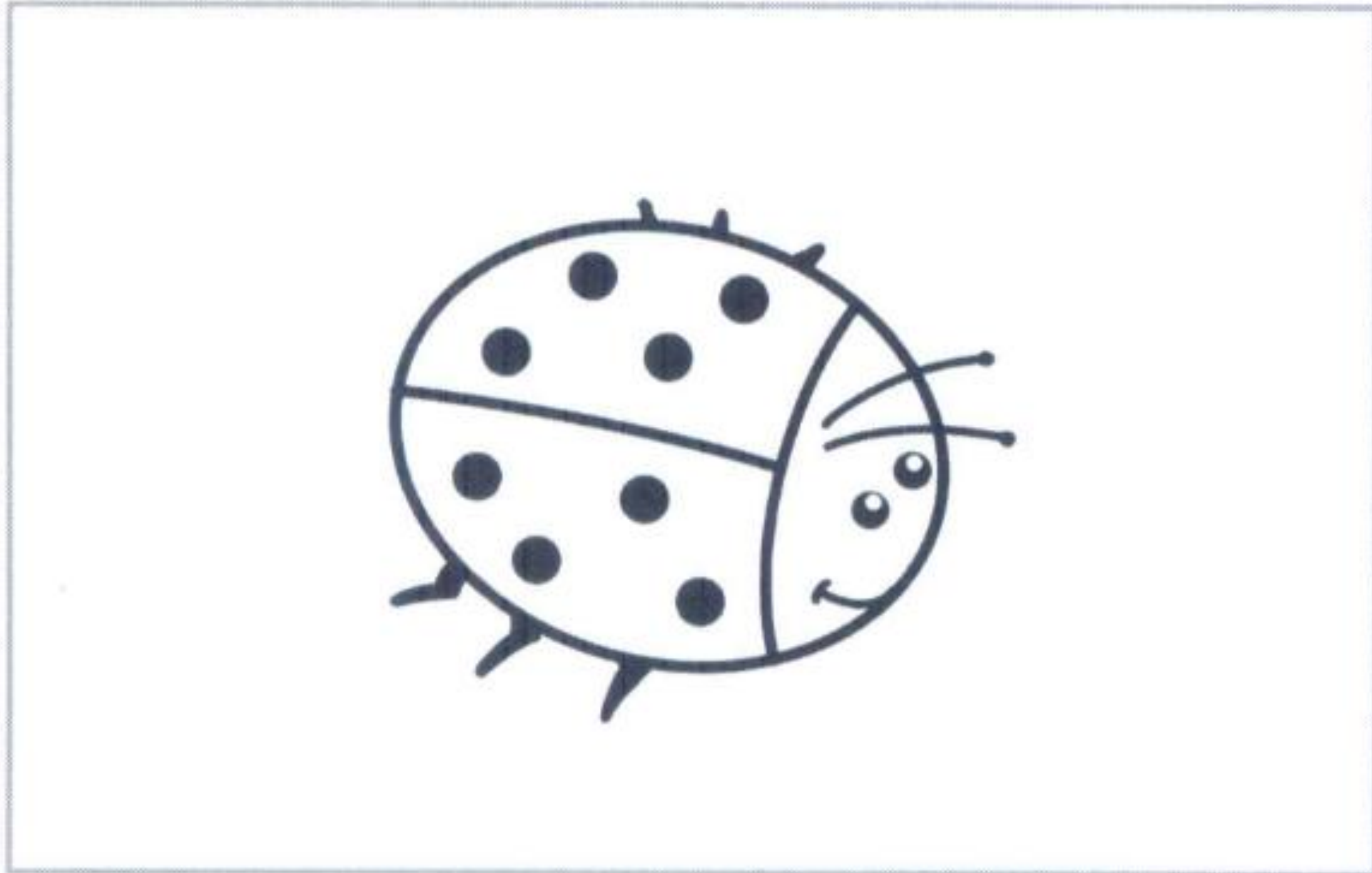

CI COC NEL LA

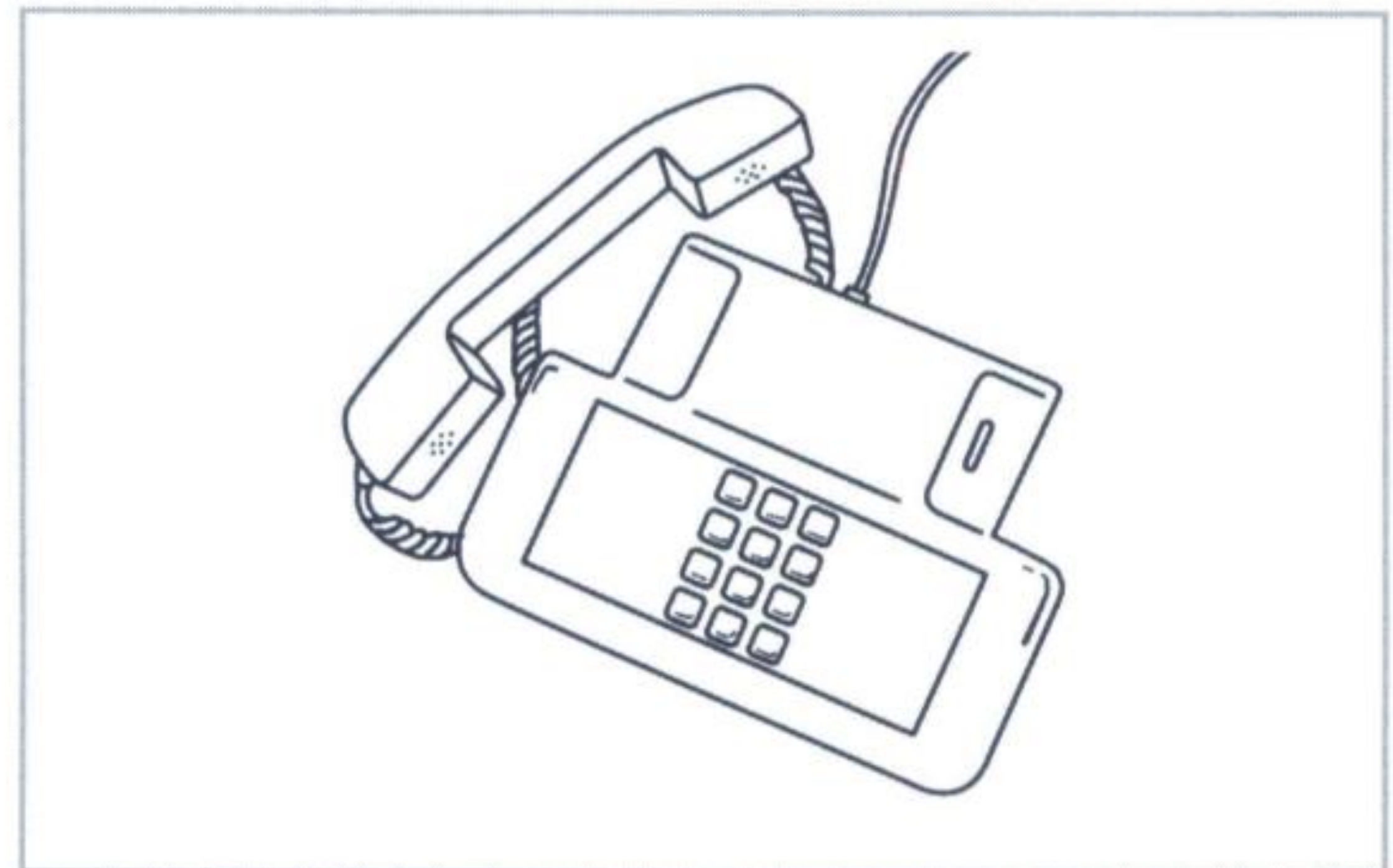

FO TE NO LE

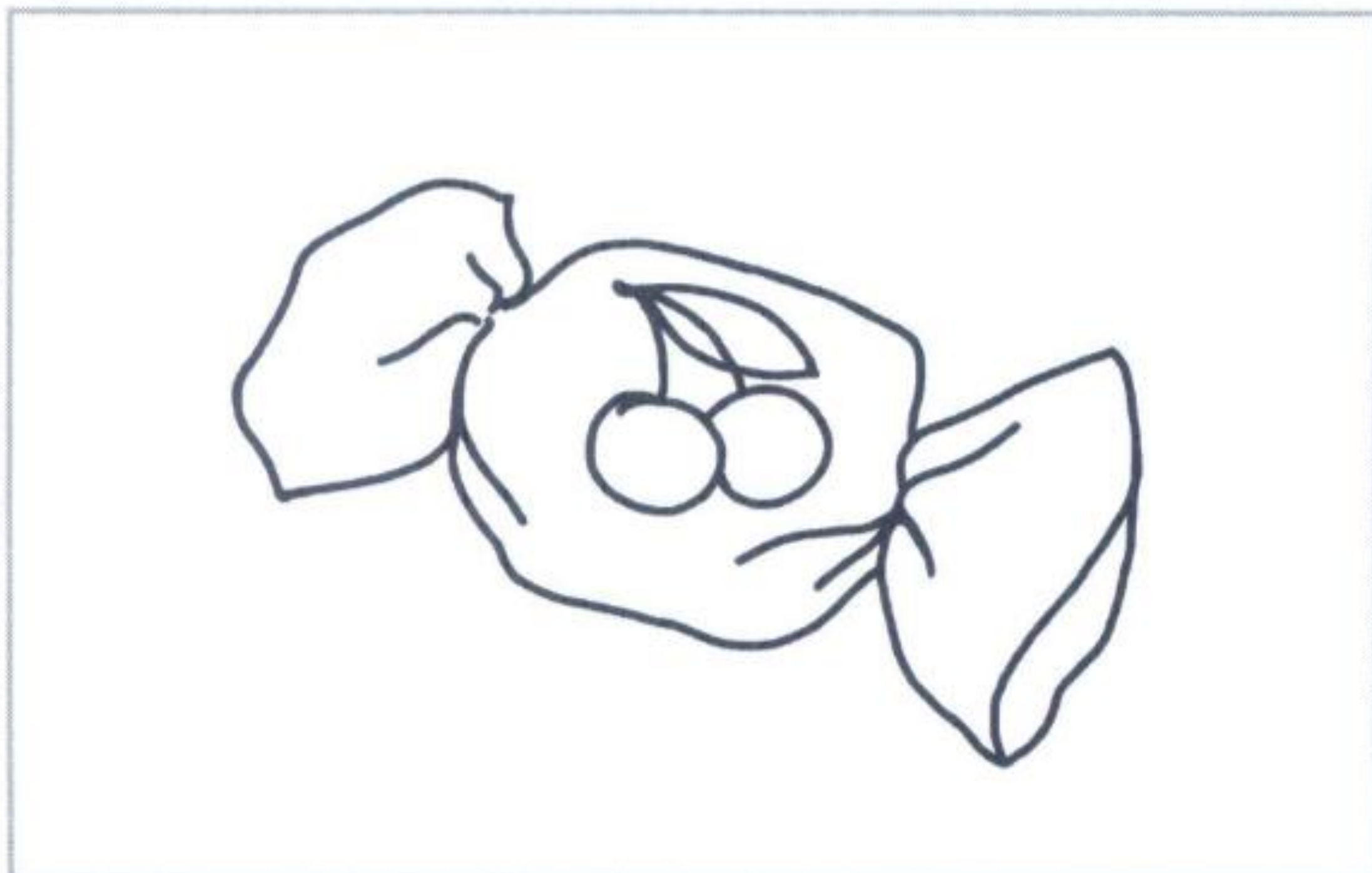

RA MEL CA LA

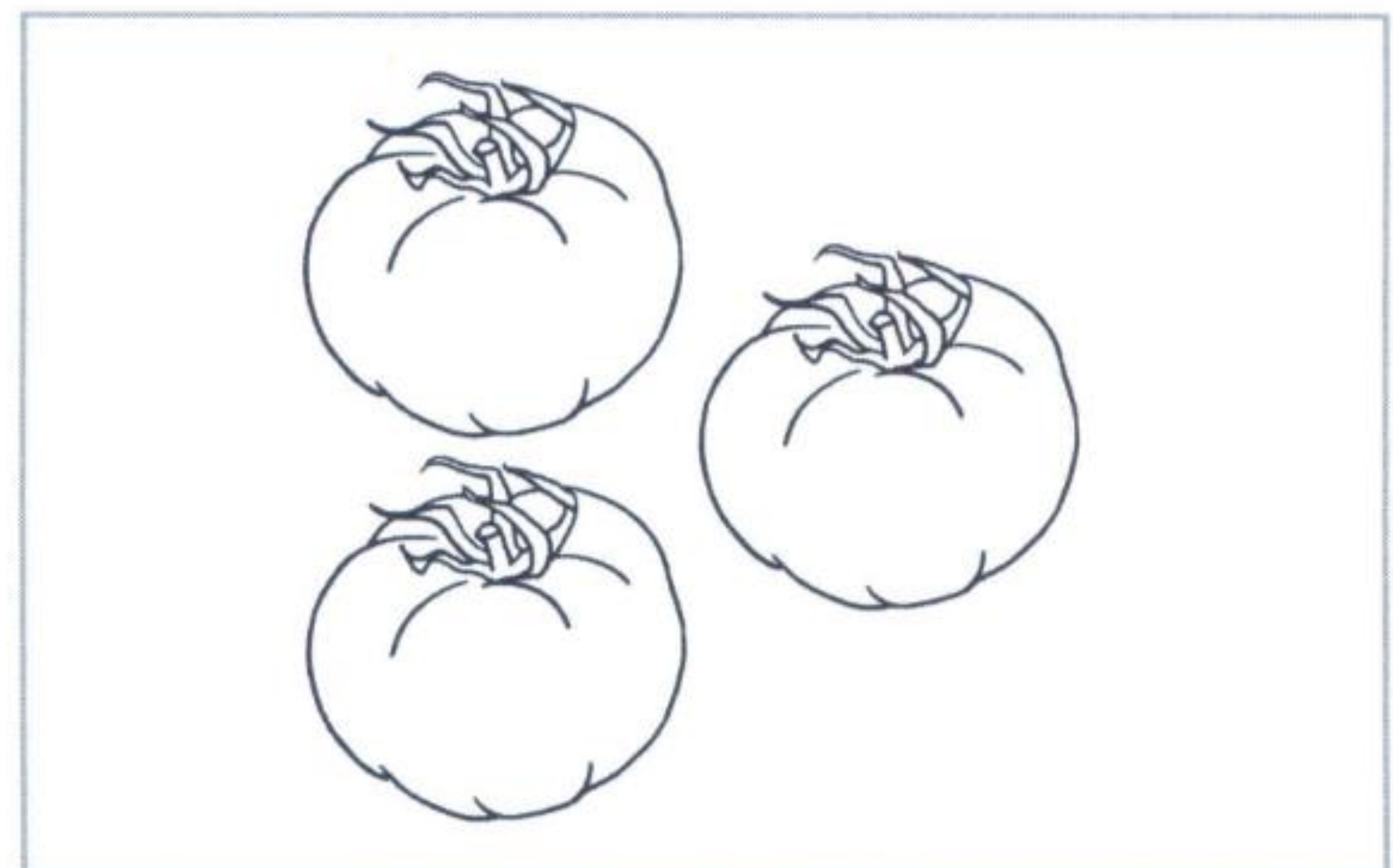

MO PO DO RI

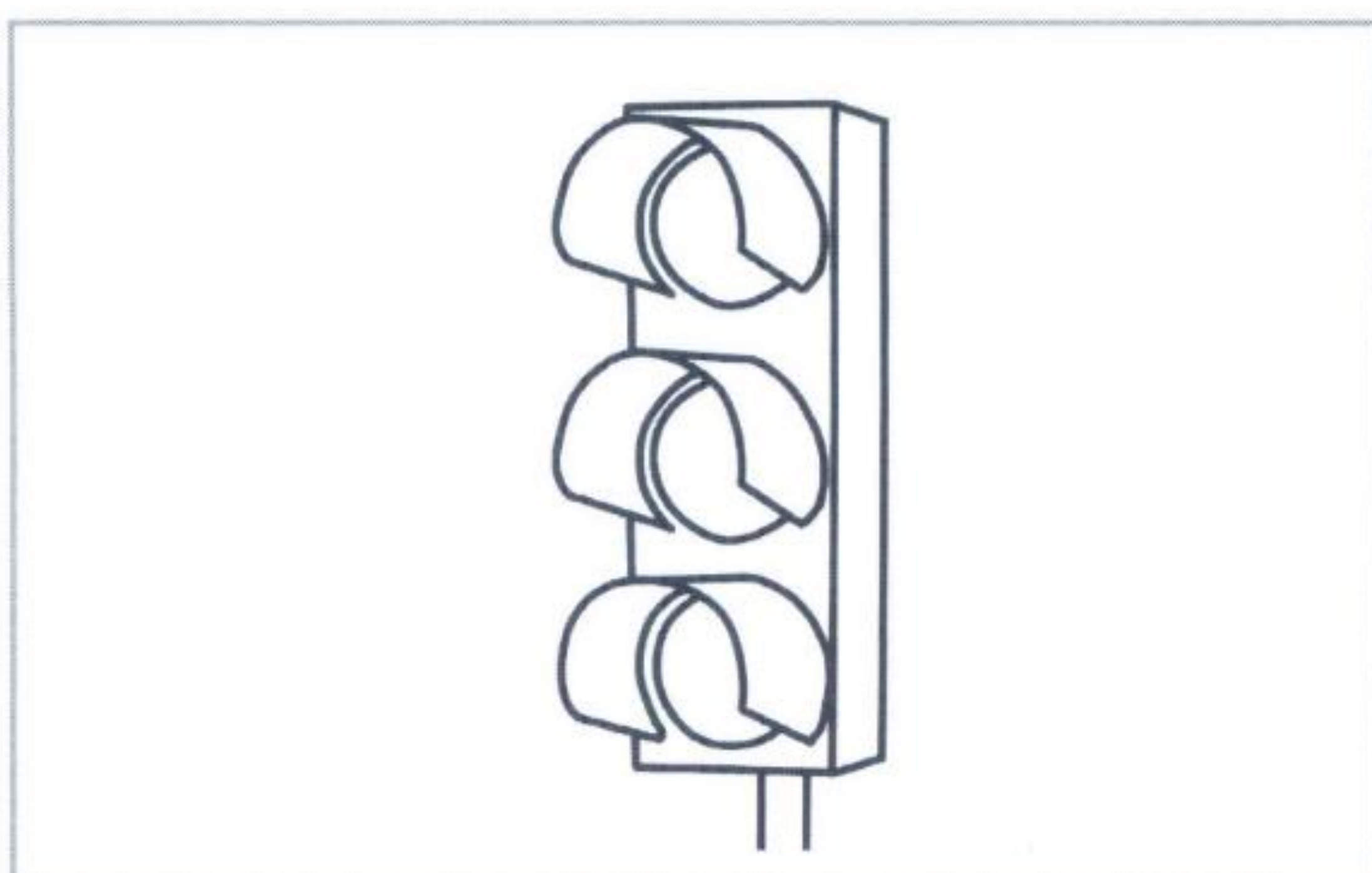

FO RO SE MA

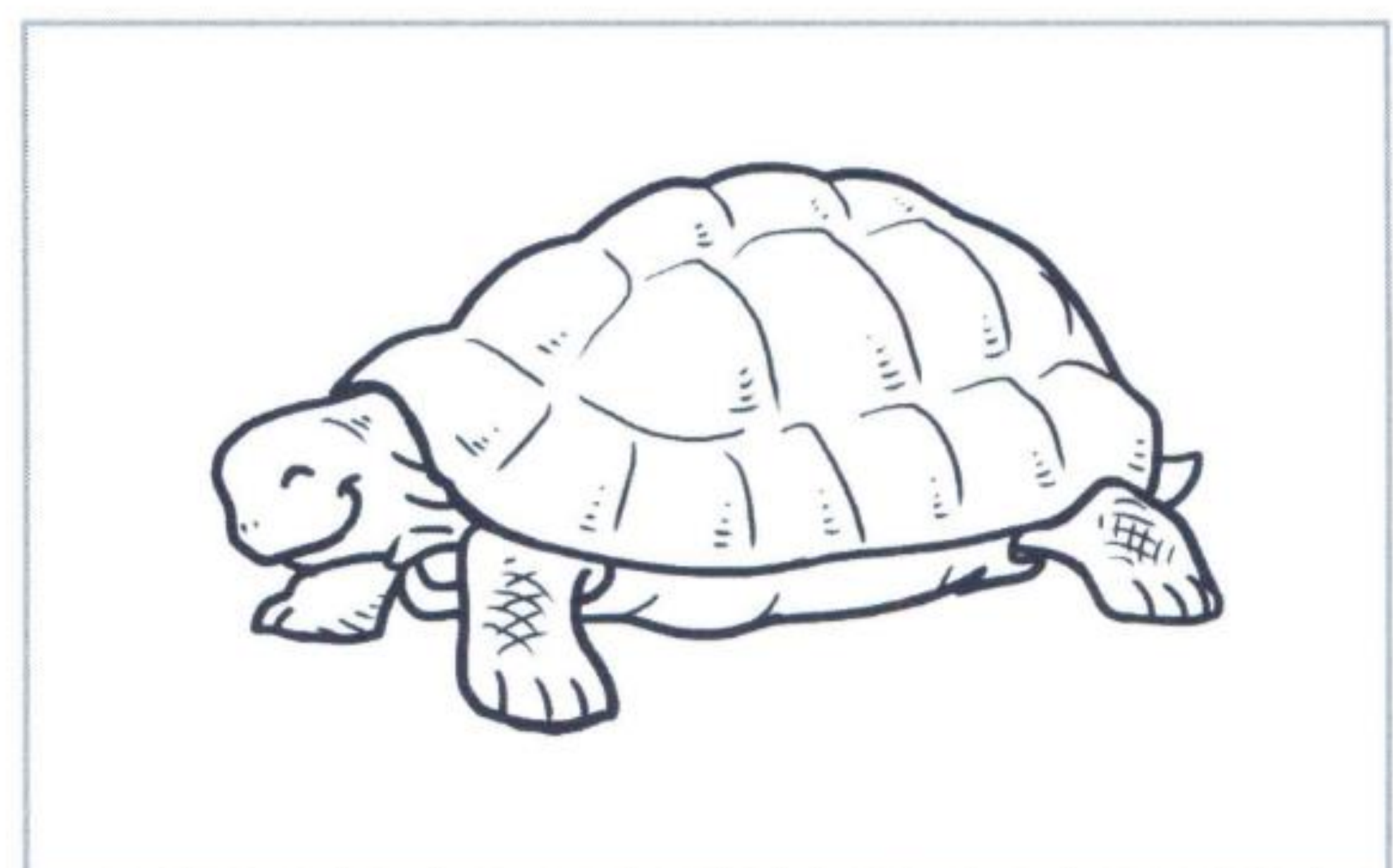

GA TAR TA RU



COLLEGA OGNI DISEGNO ALLE LETTERE INIZIALI
CORRISPONDENTI

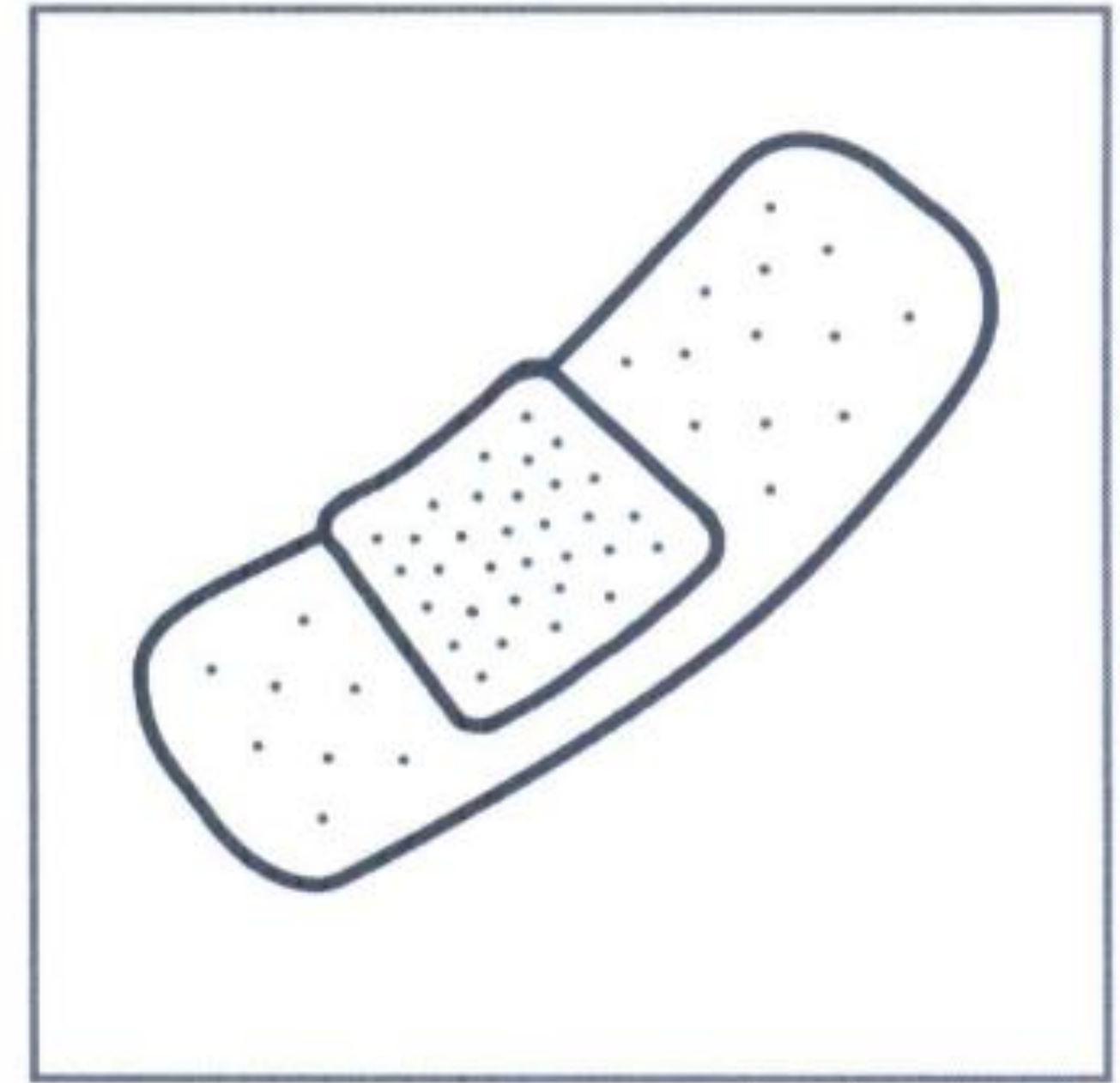
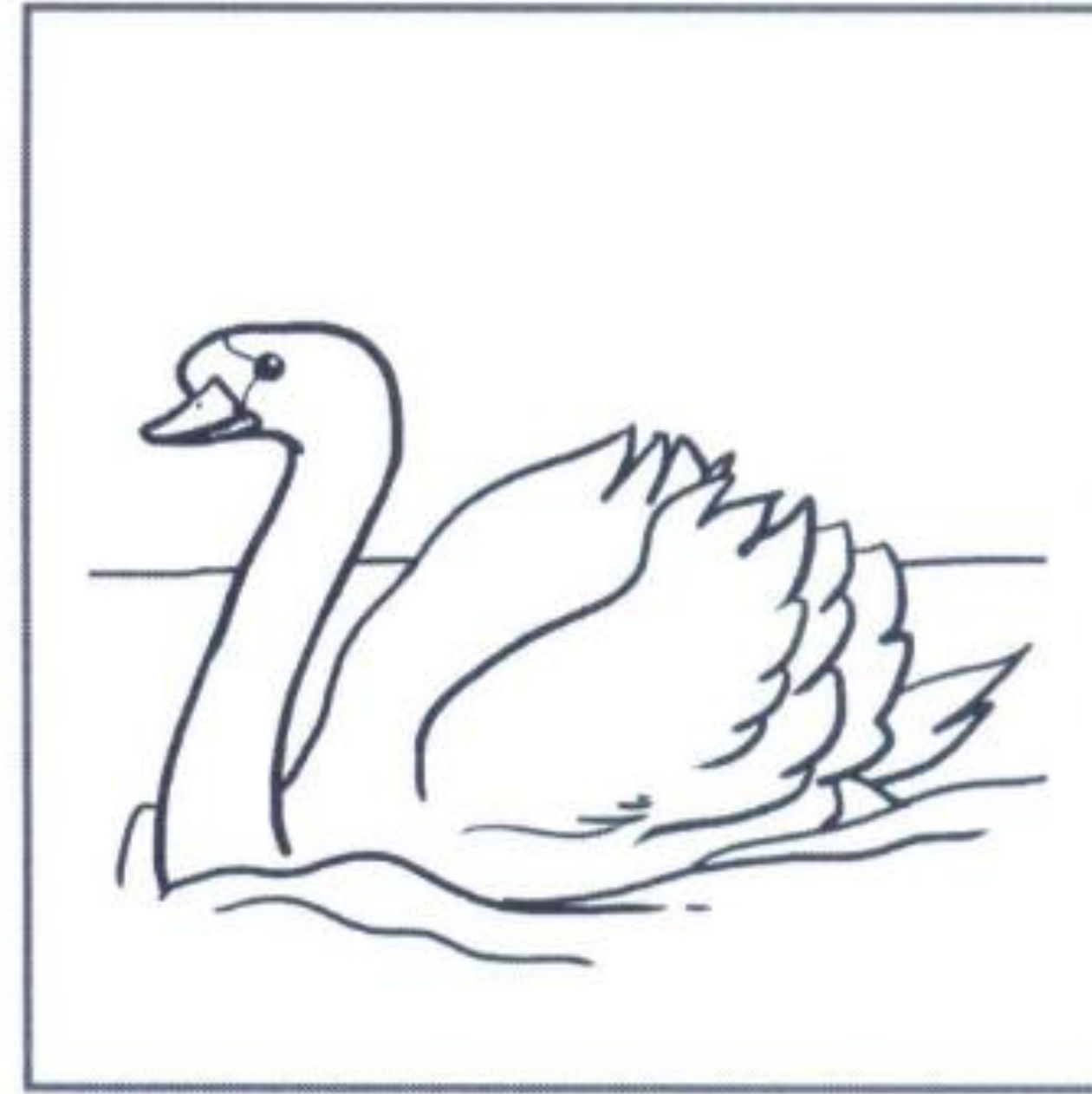
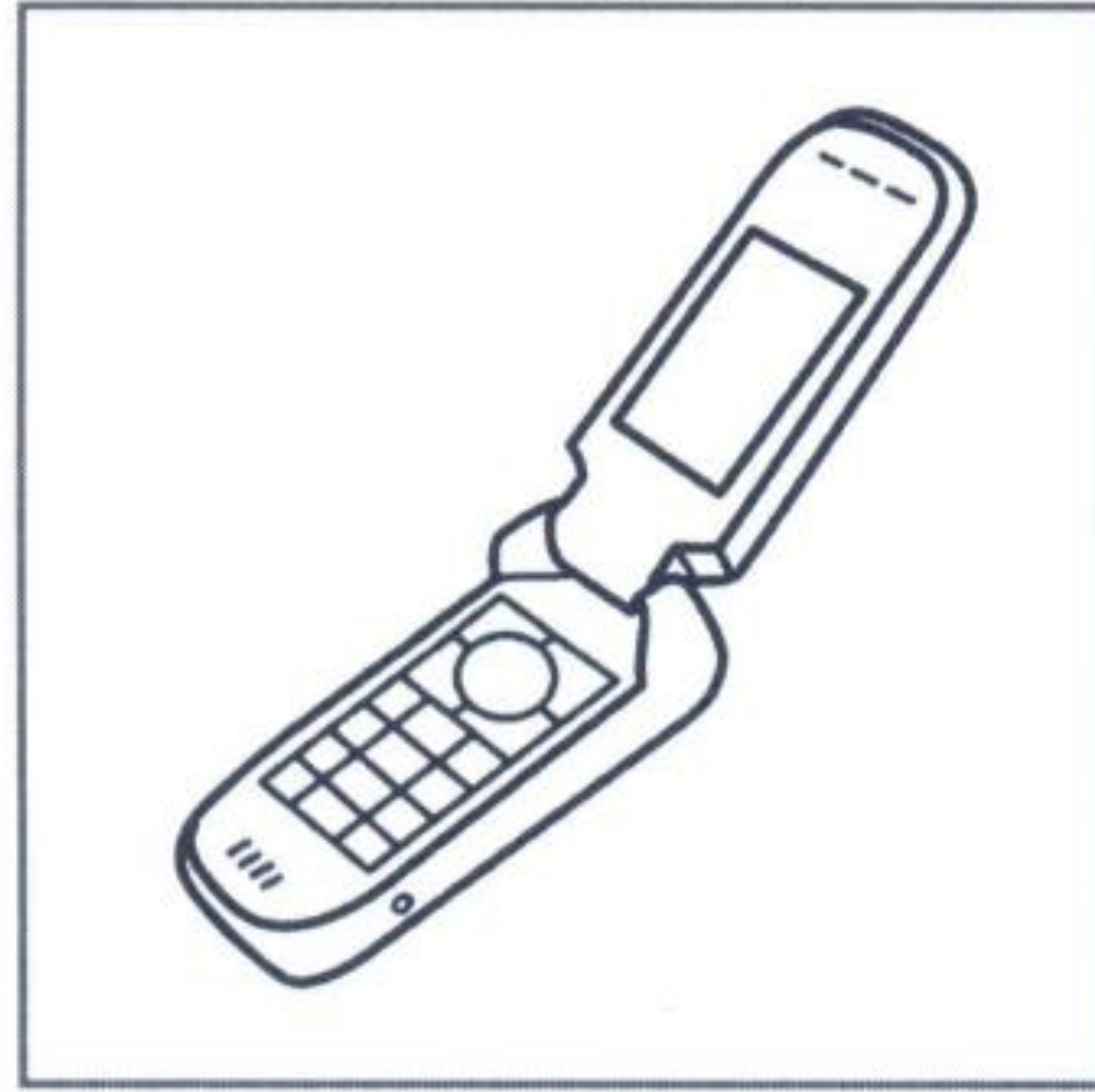
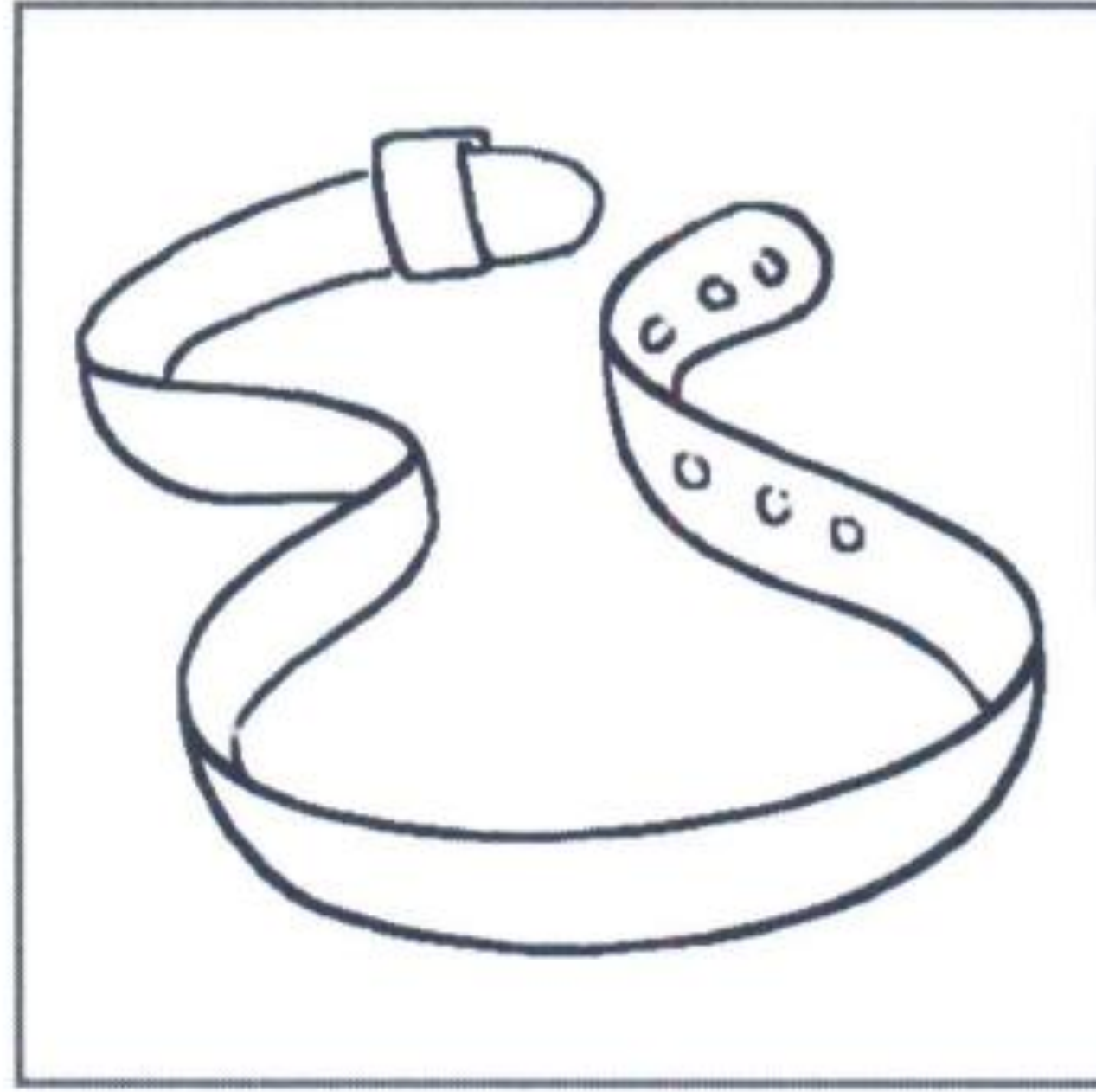

CI

CE

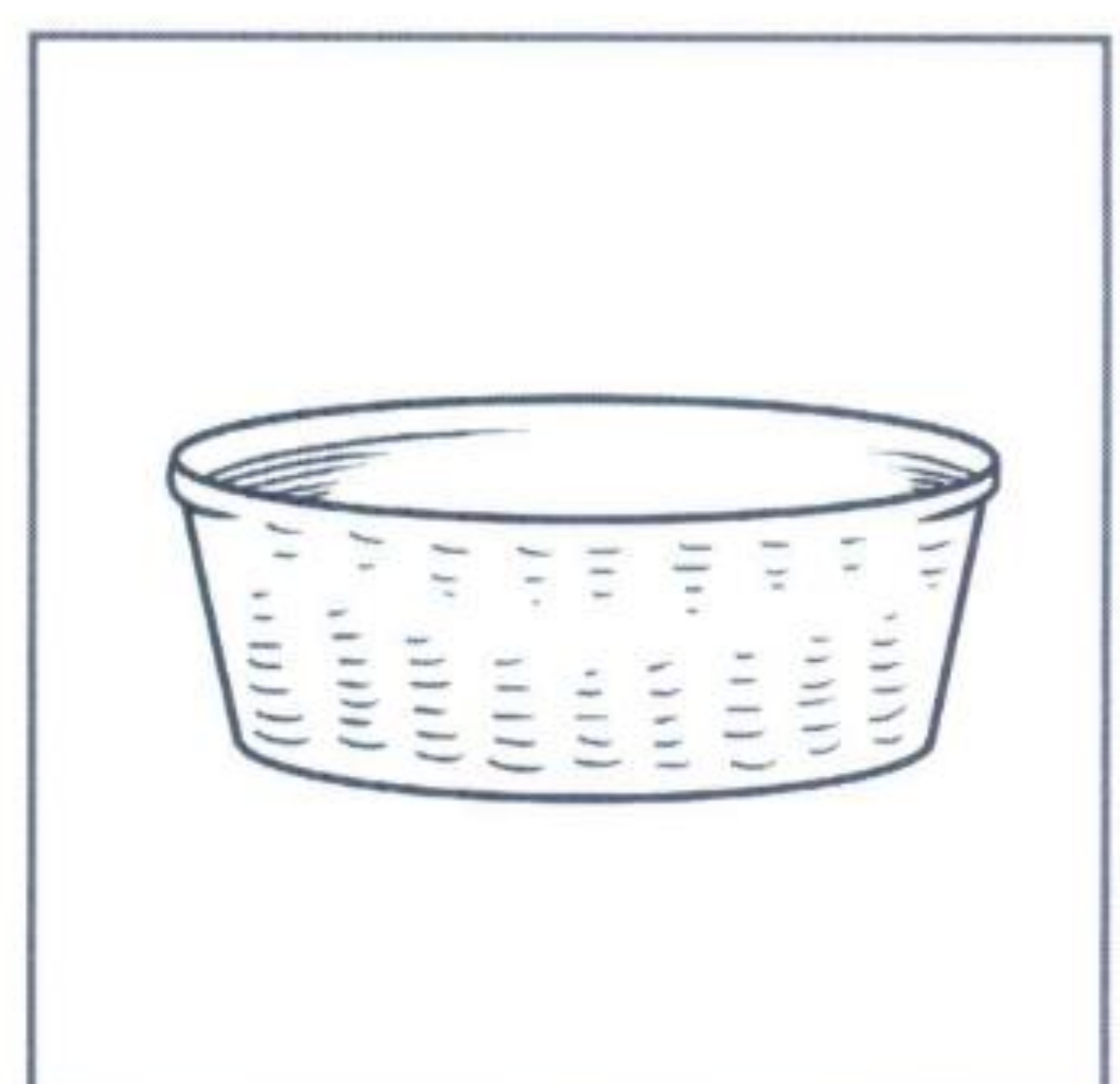
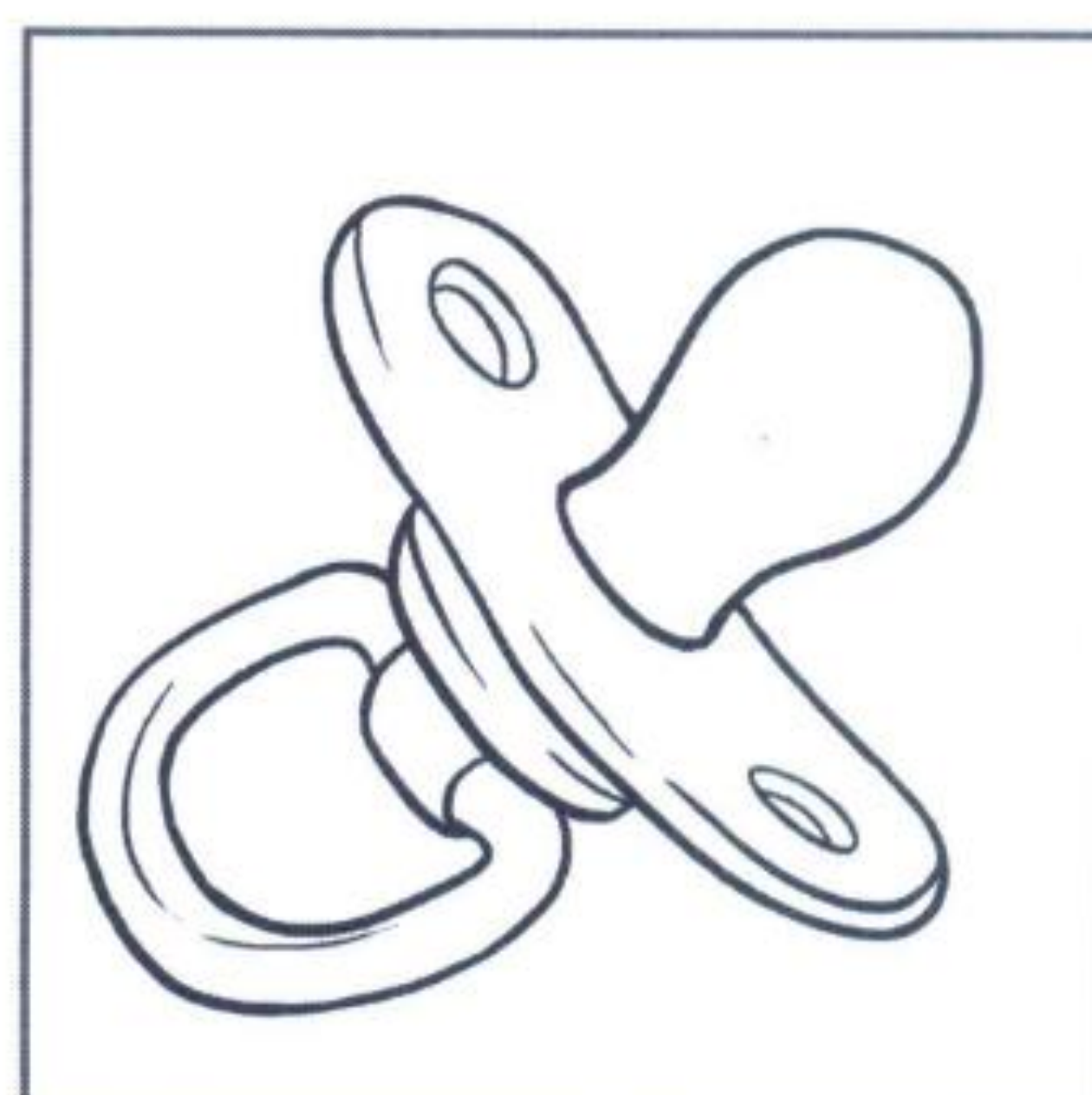
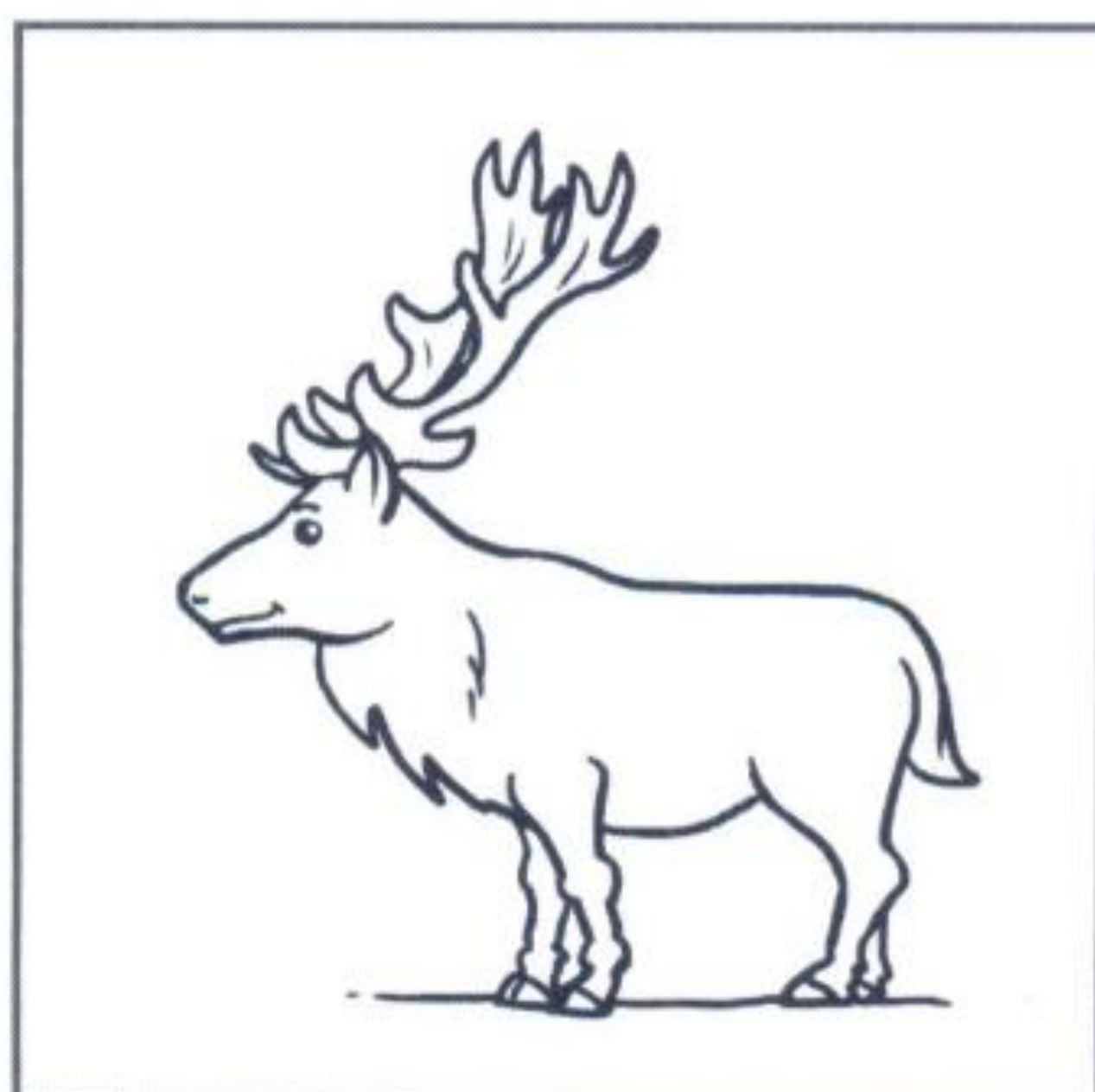

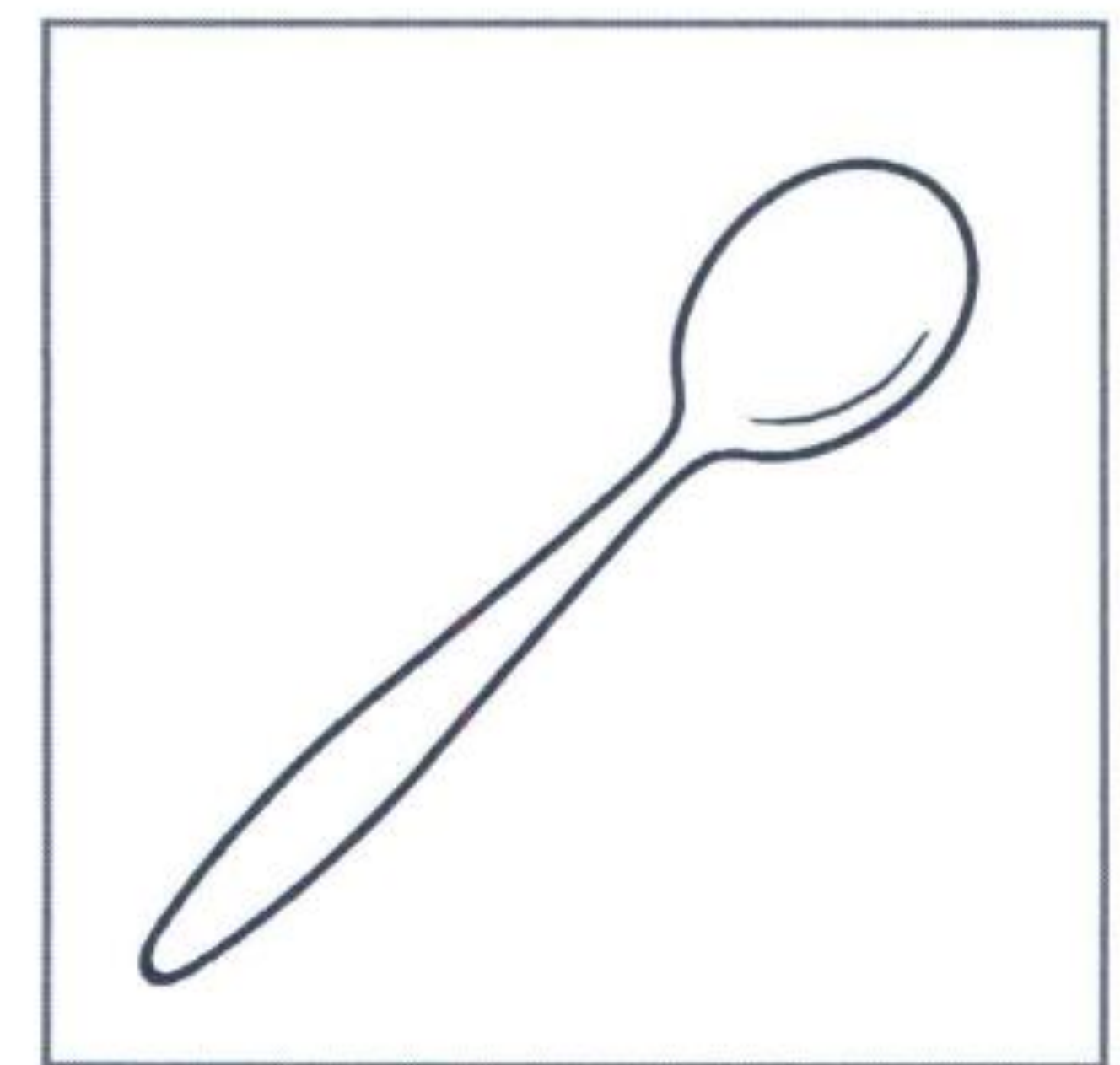
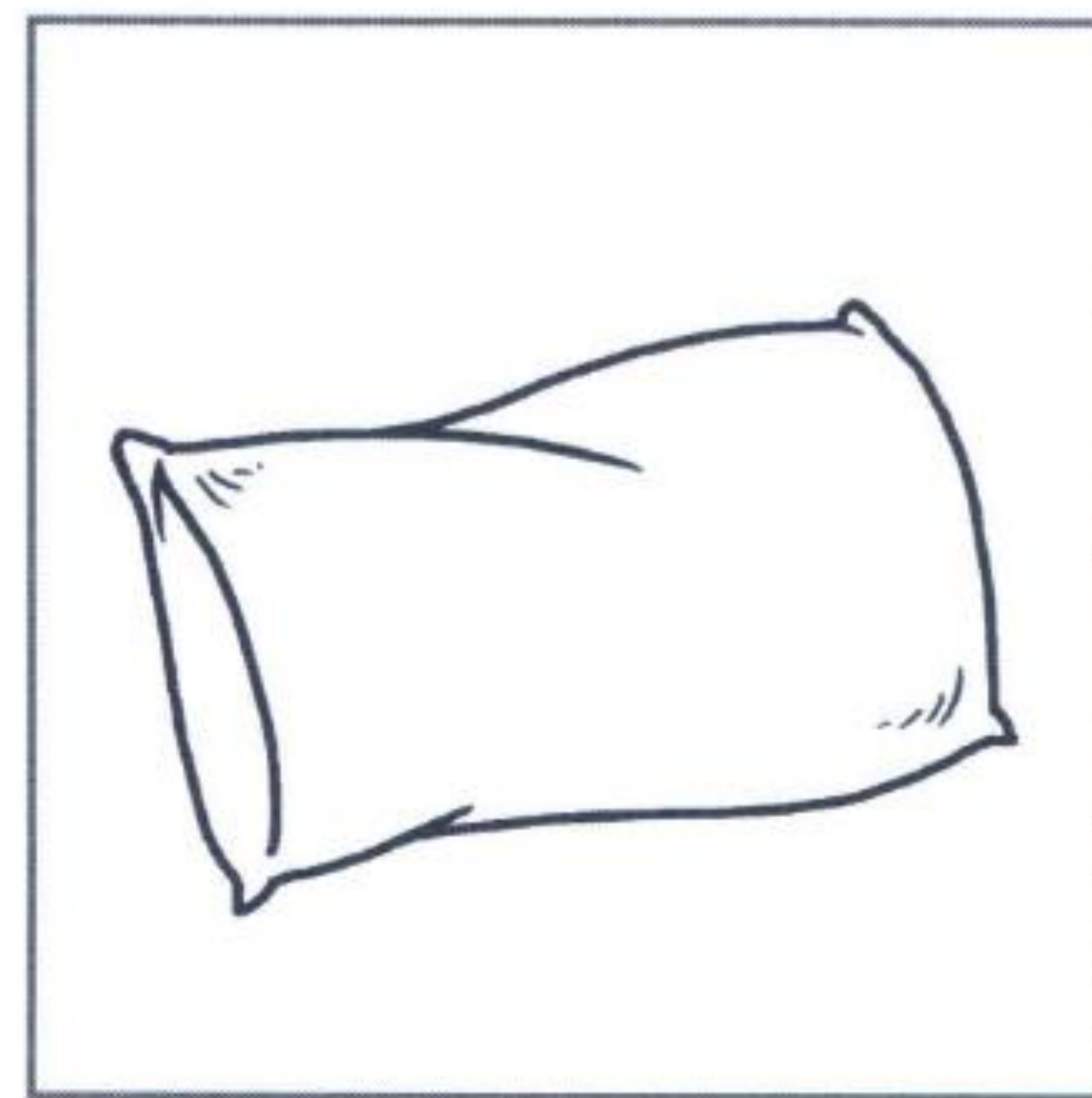
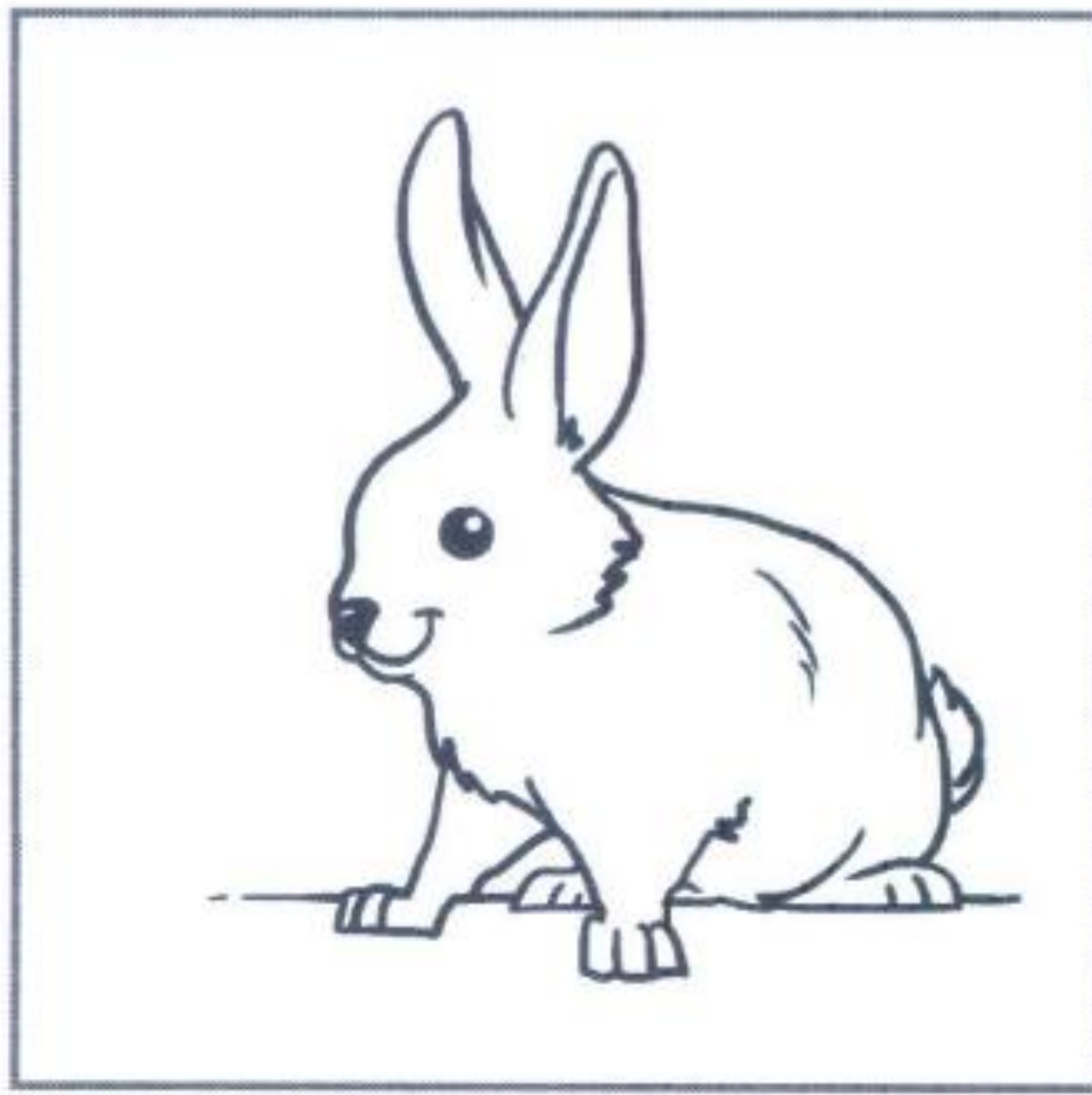

CA

CO

CU

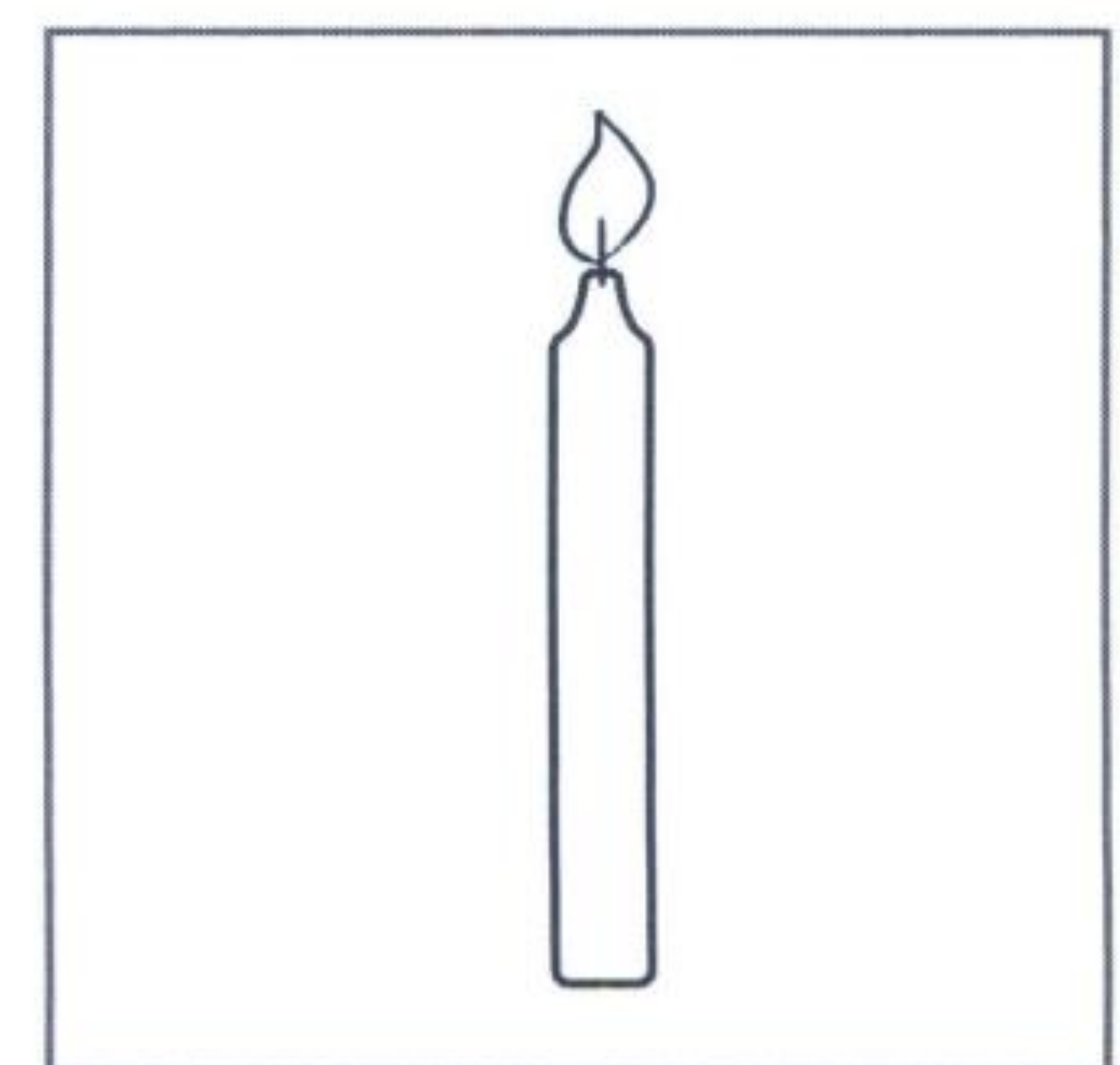
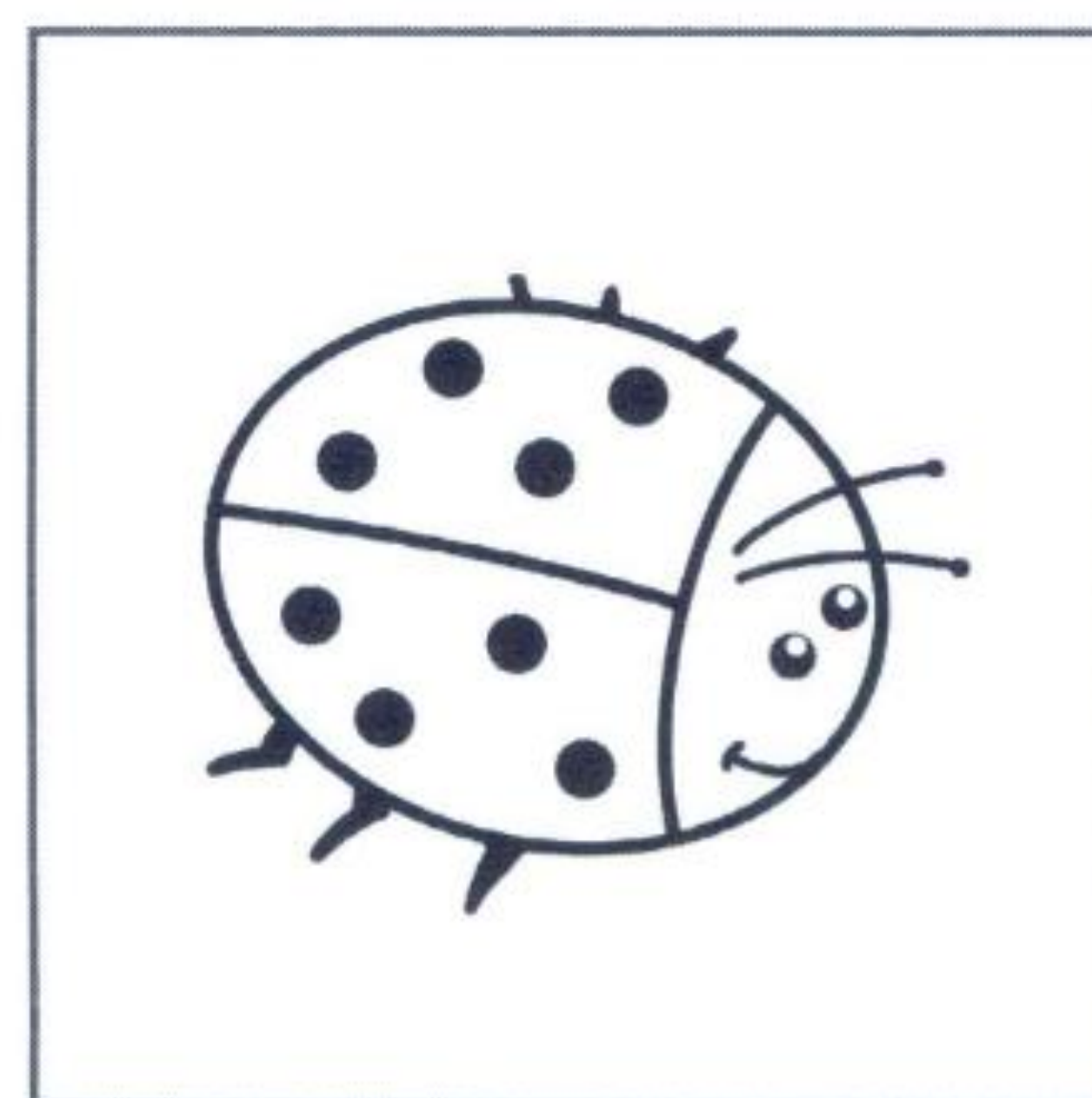
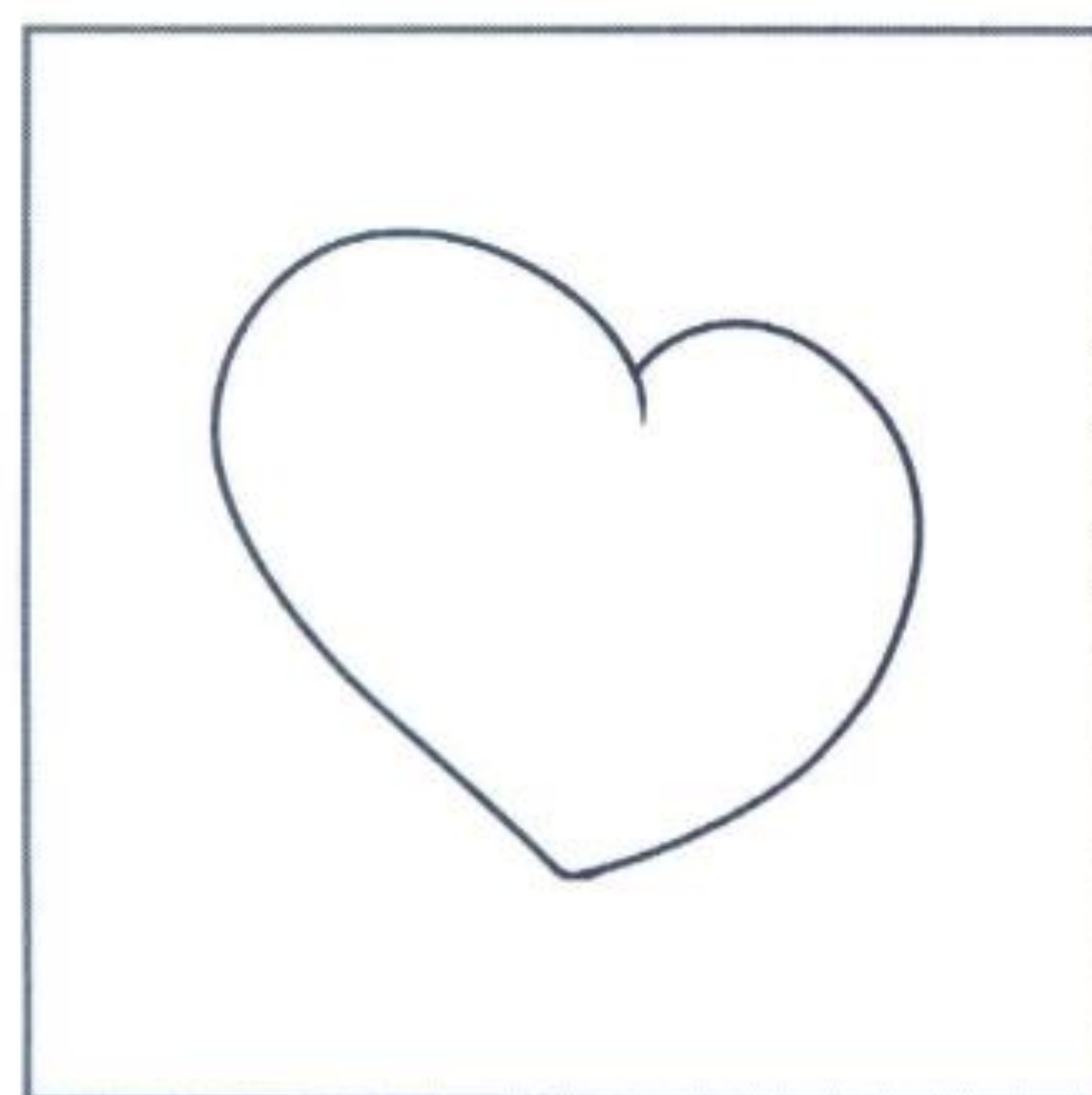
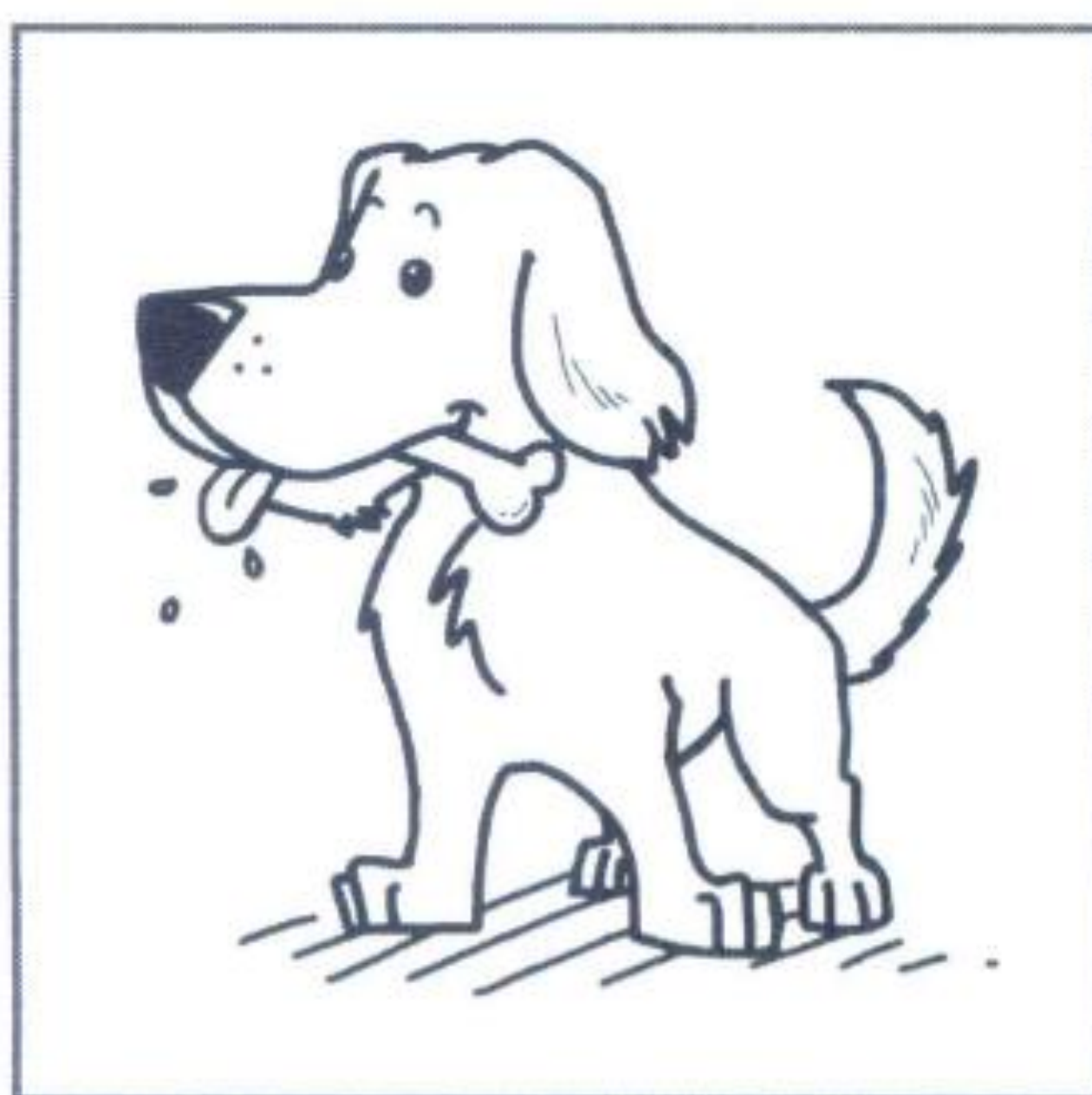



COLLEGA OGNI DISEGNO ALLE LETTERE INIZIALI
CORRISPONDENTI



SCHEDA

67

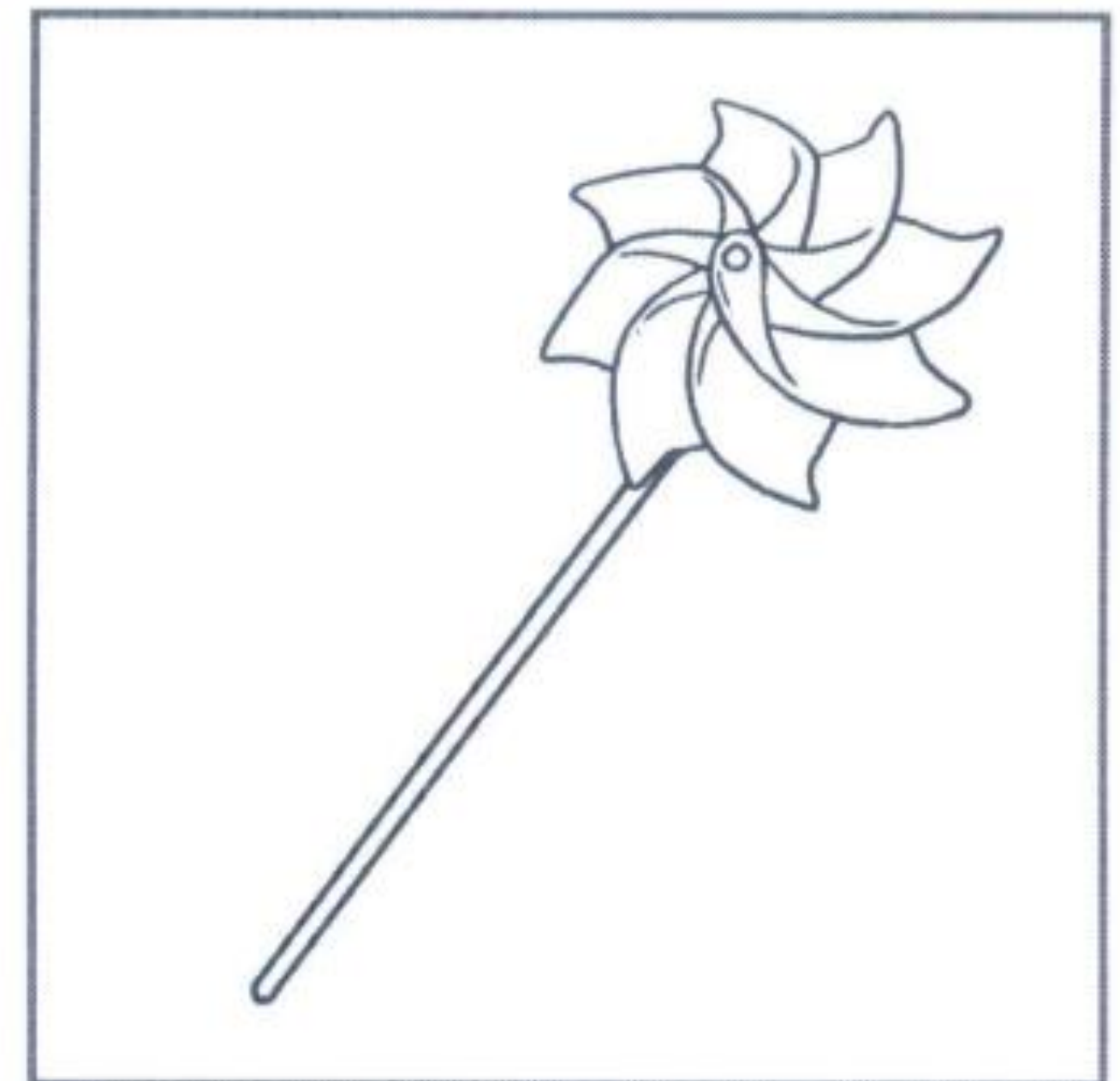
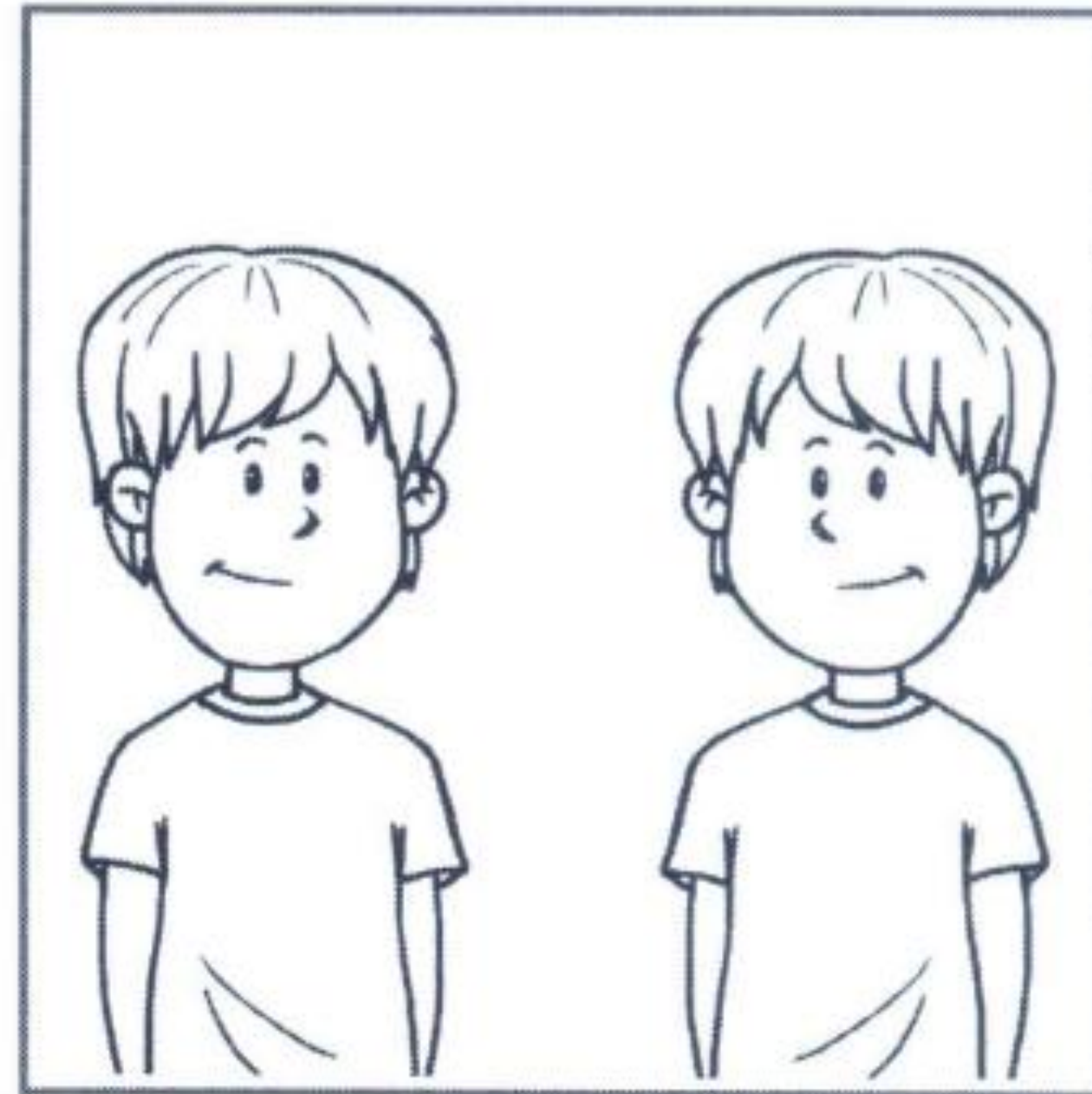
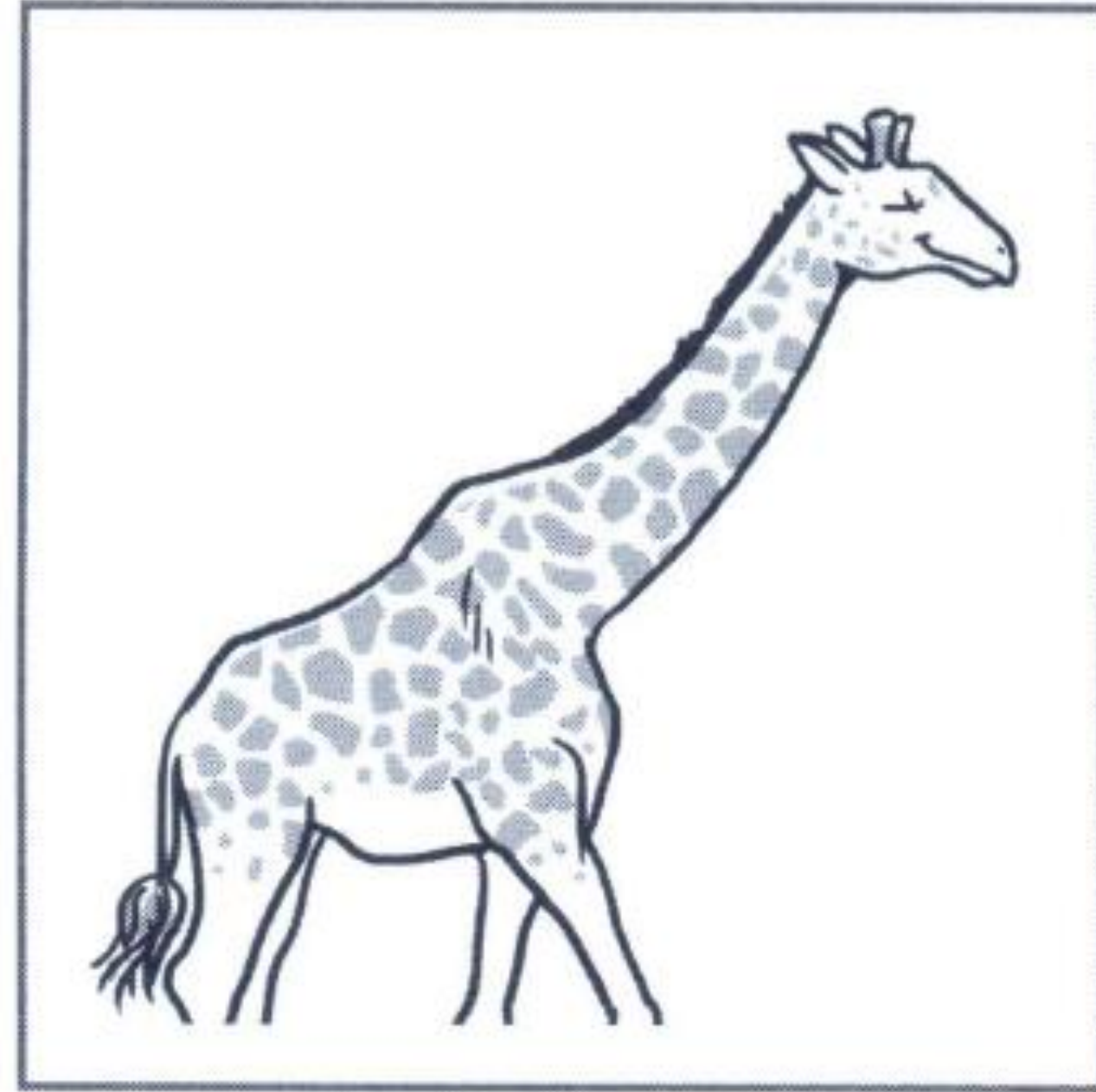
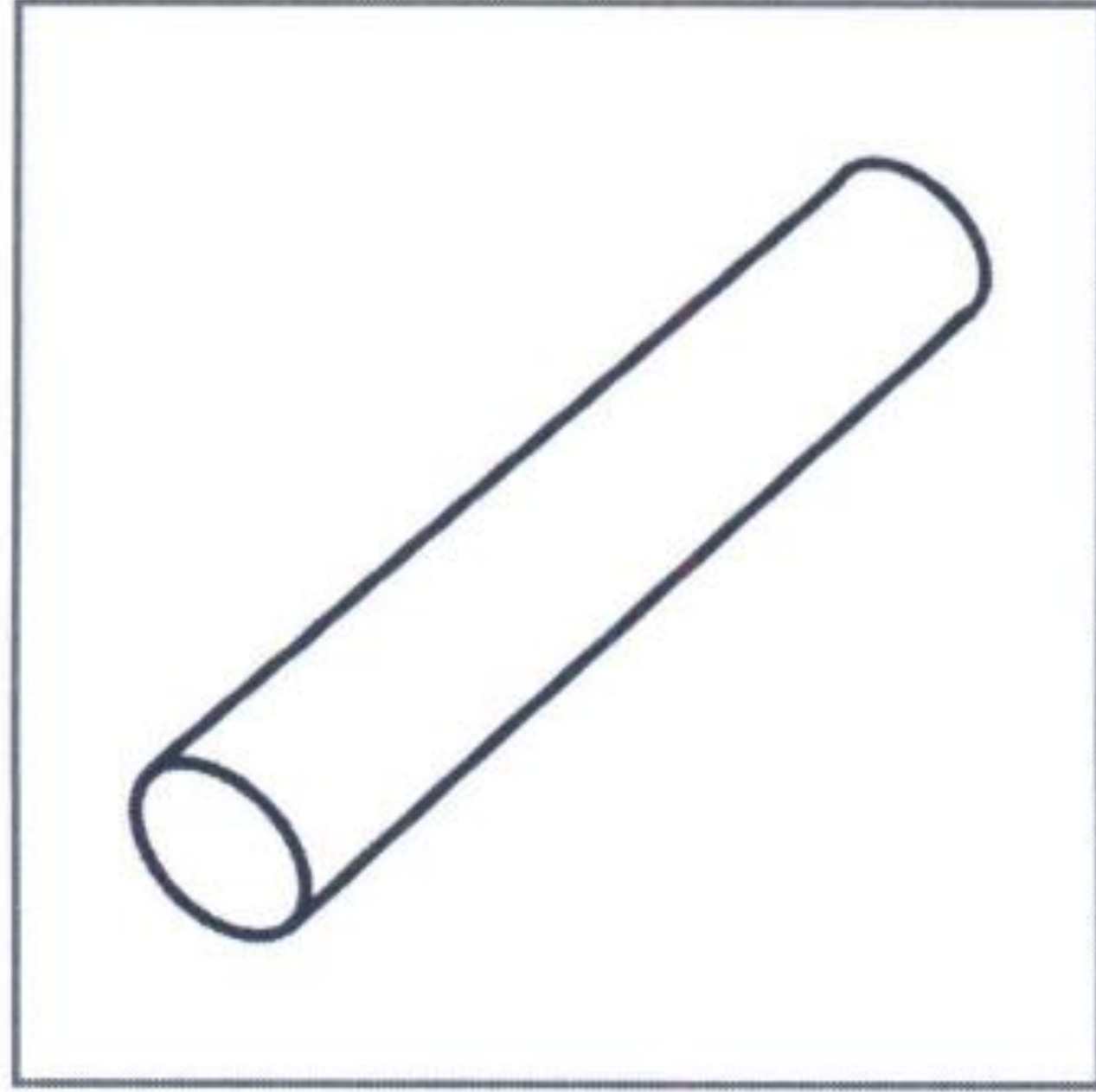

GI

GE

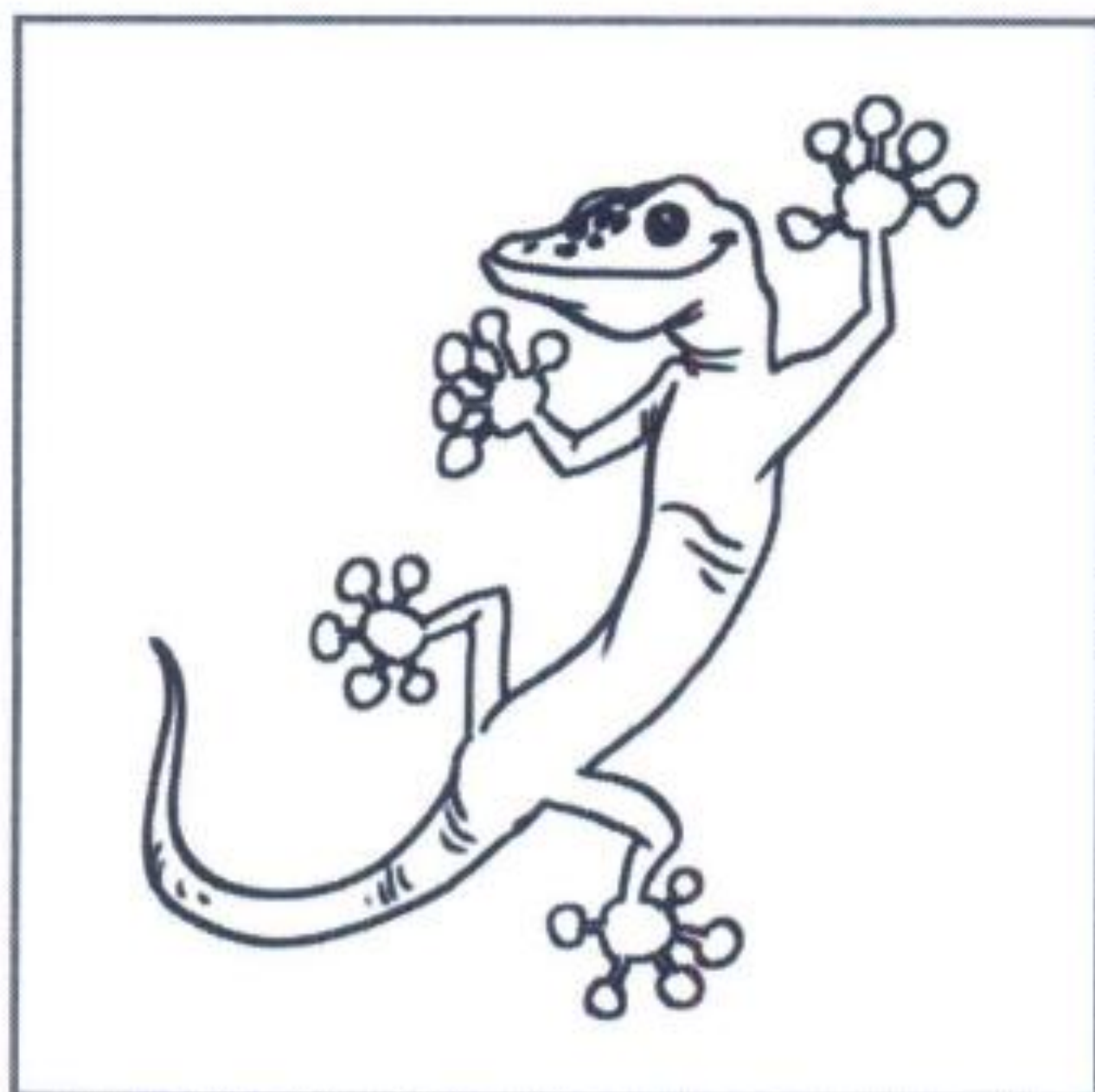

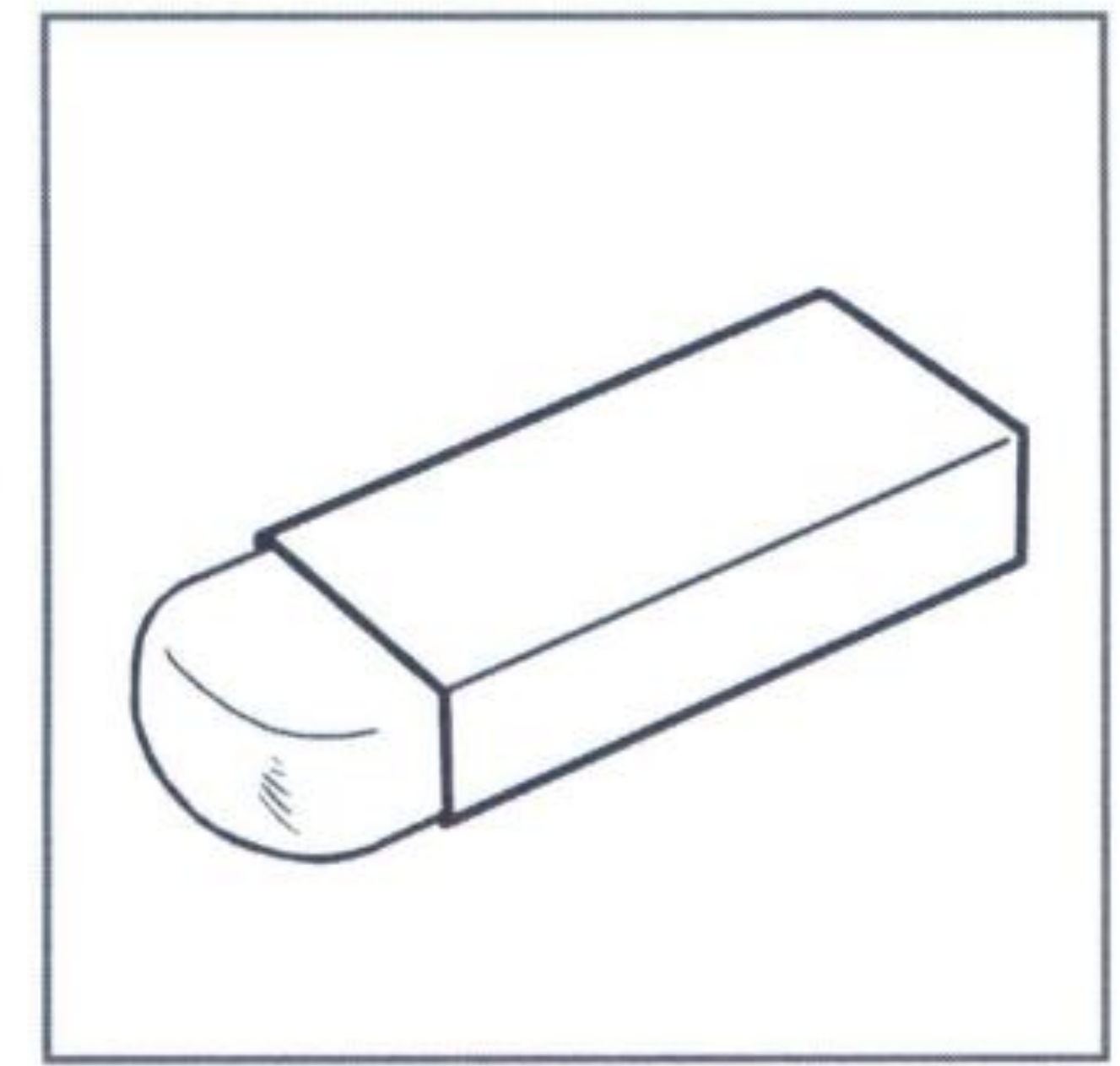
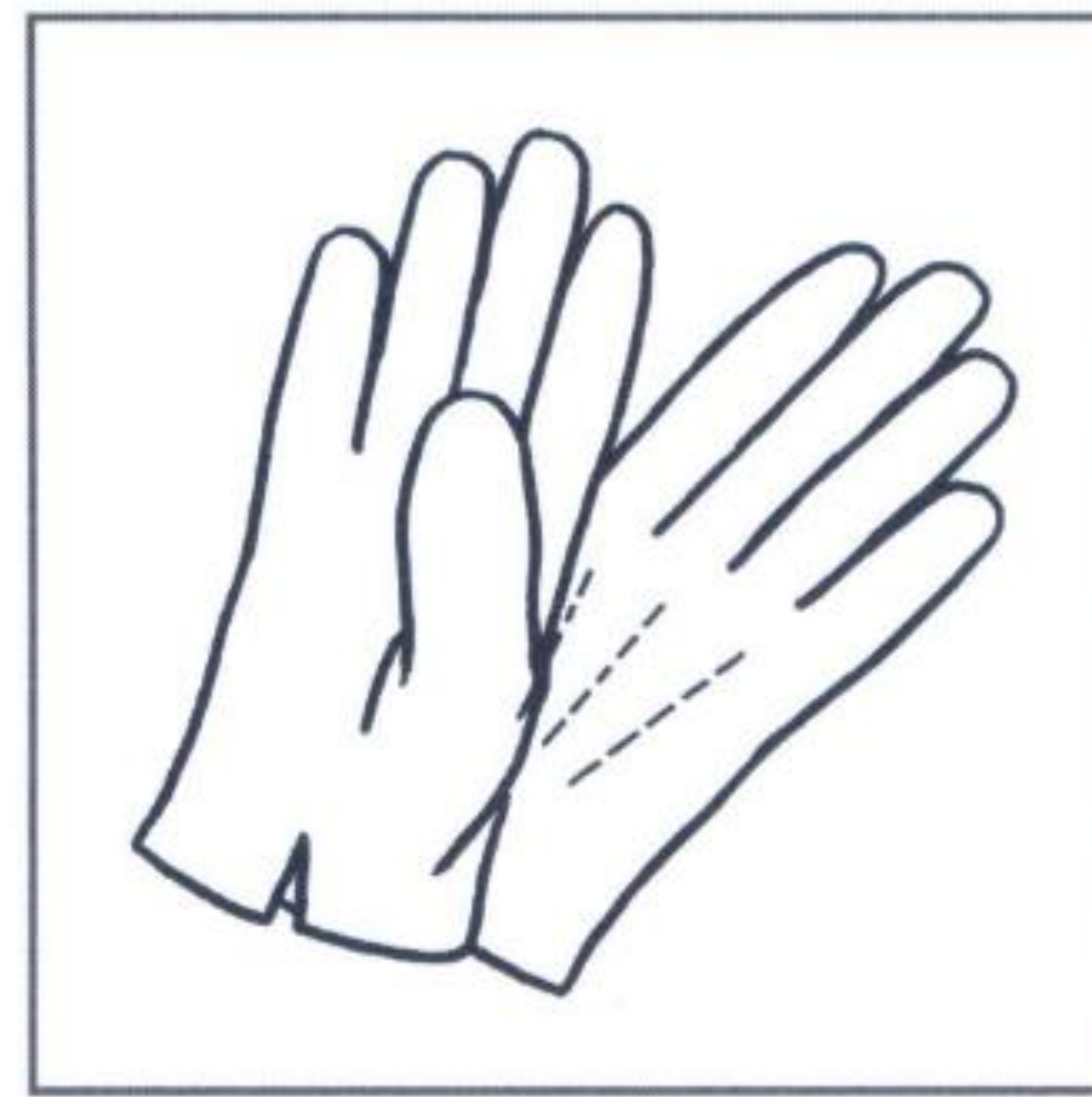
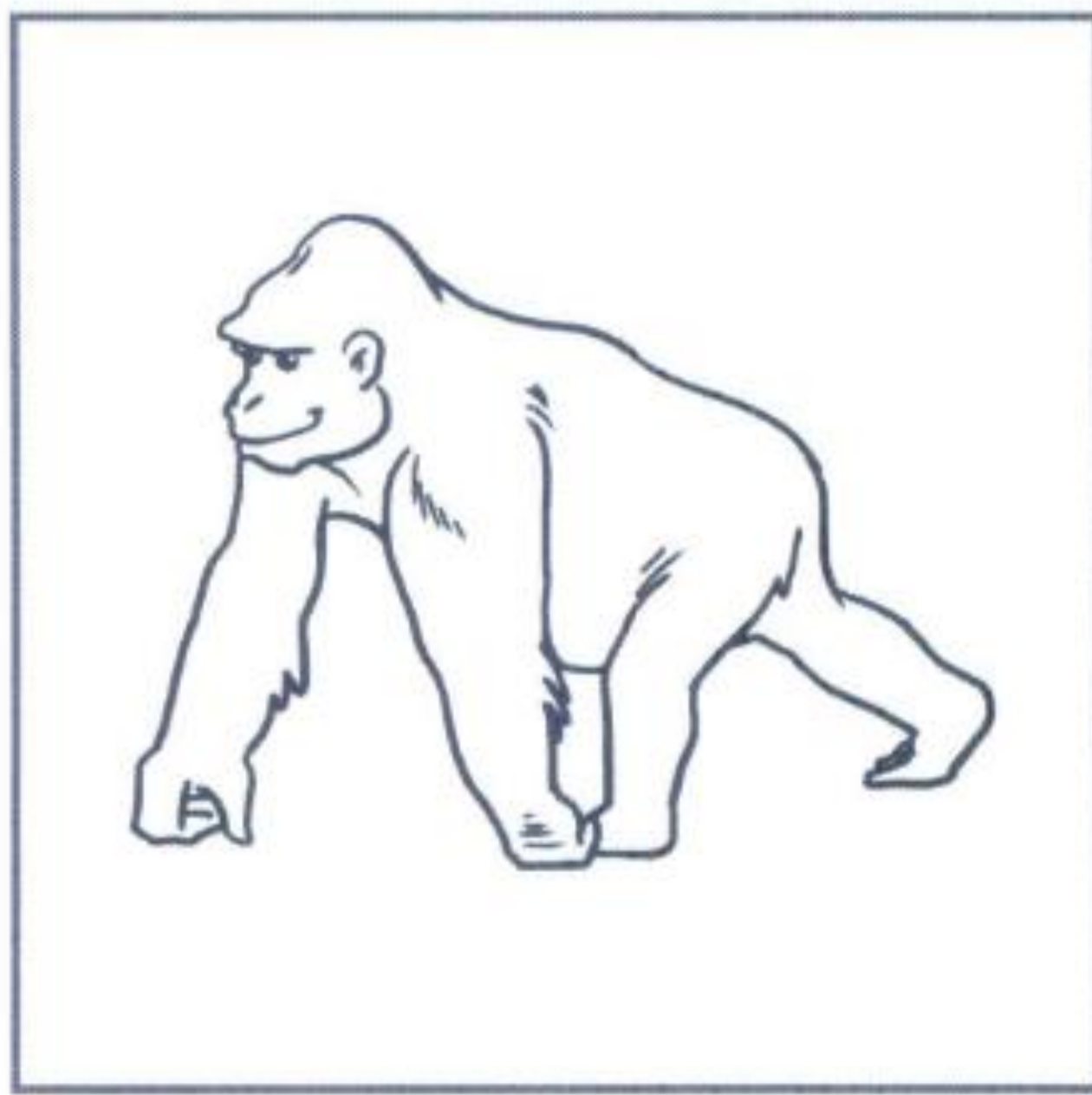

GA

GO

GU

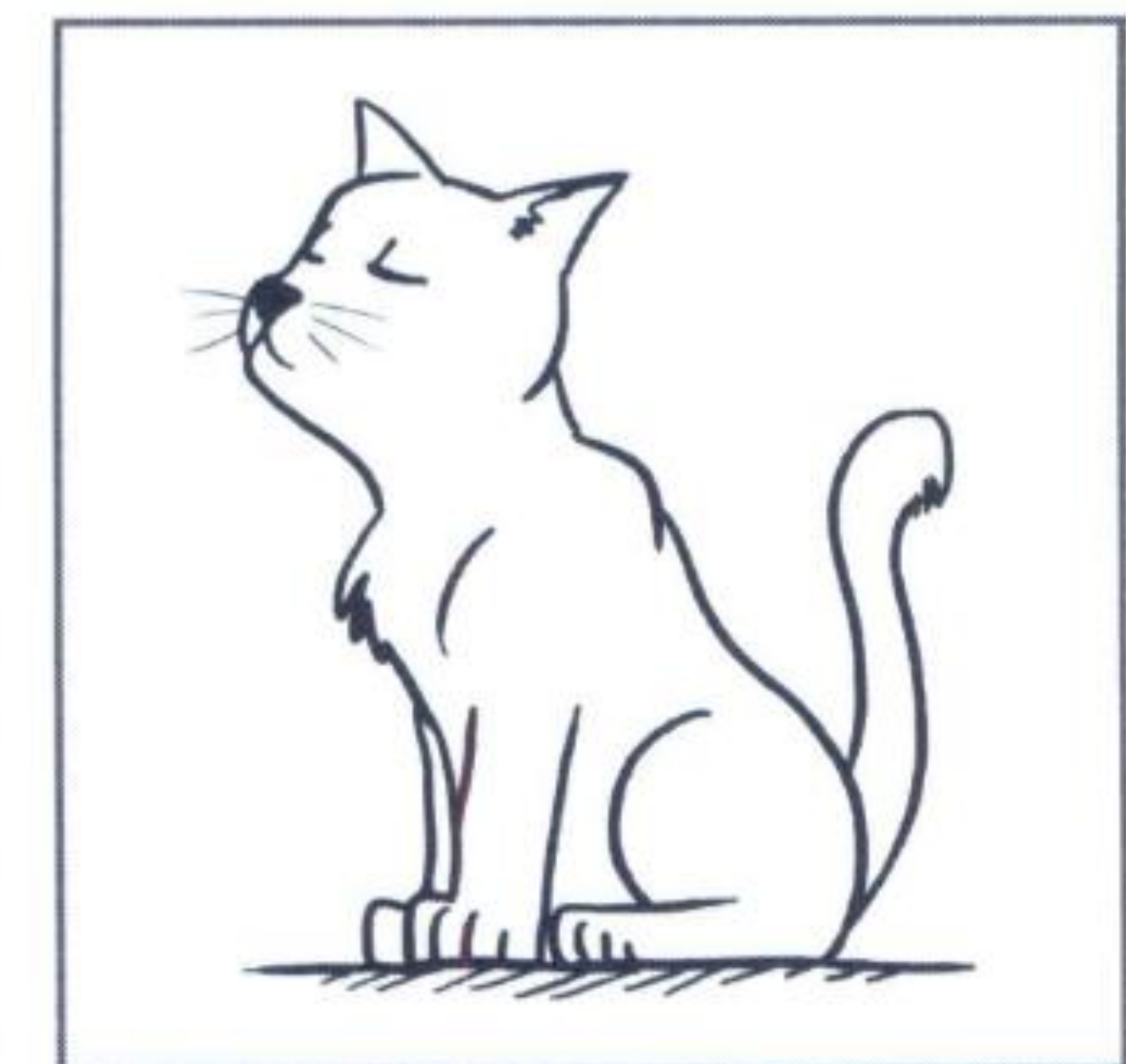
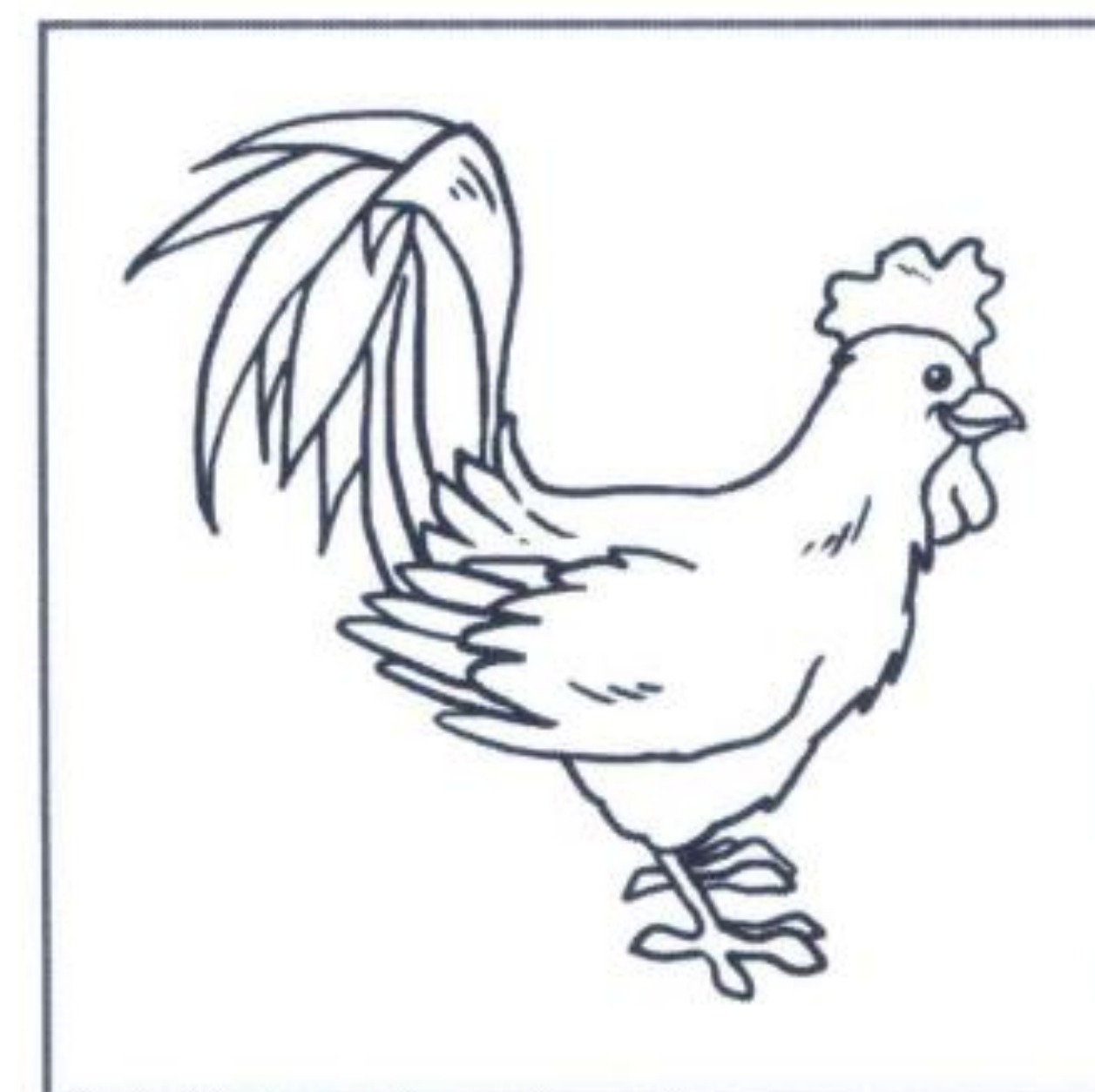
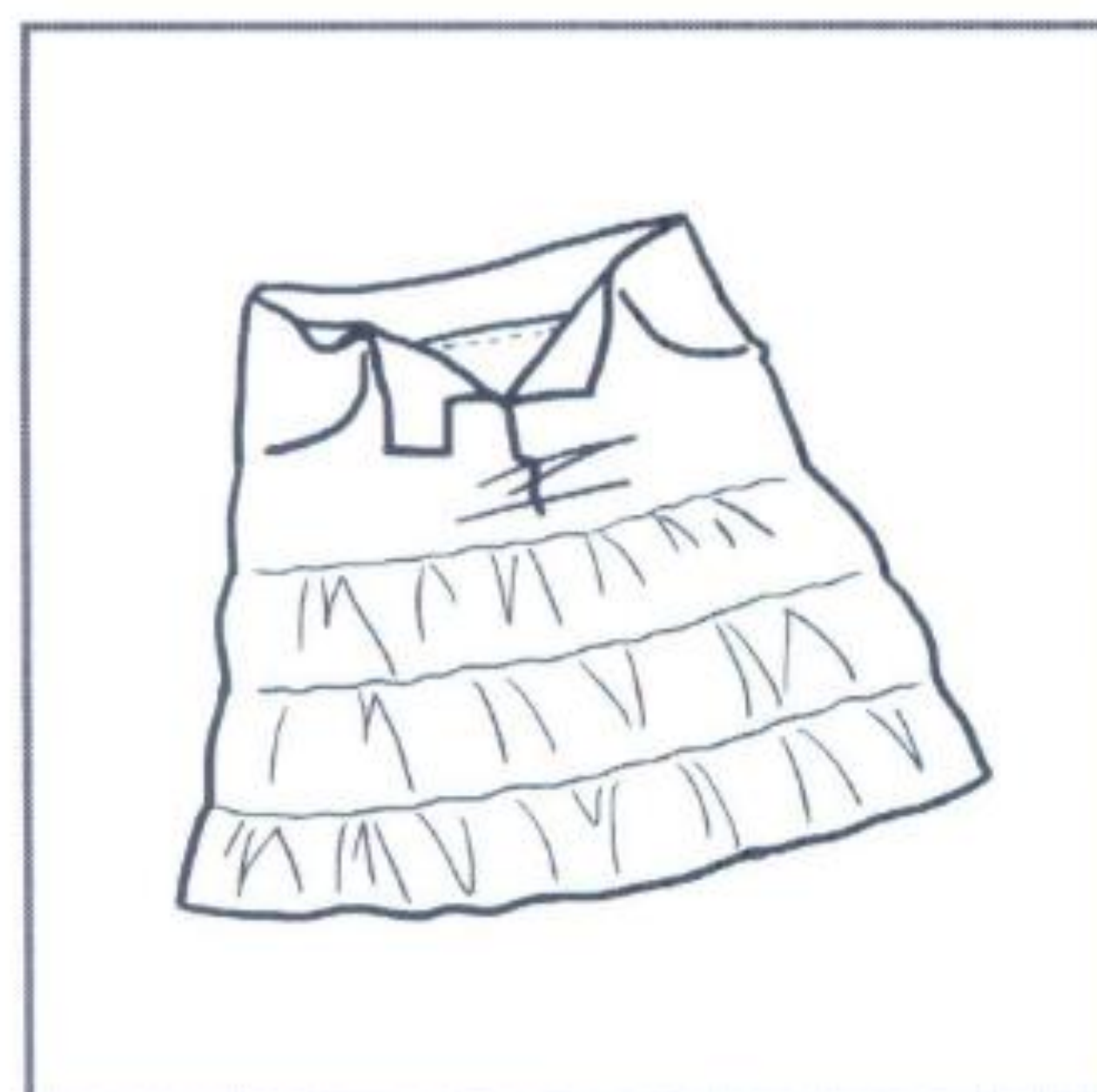



COMPLETA LE PAROLE INSERENDO «GI», «GE»,
«GHI» O «GHE»

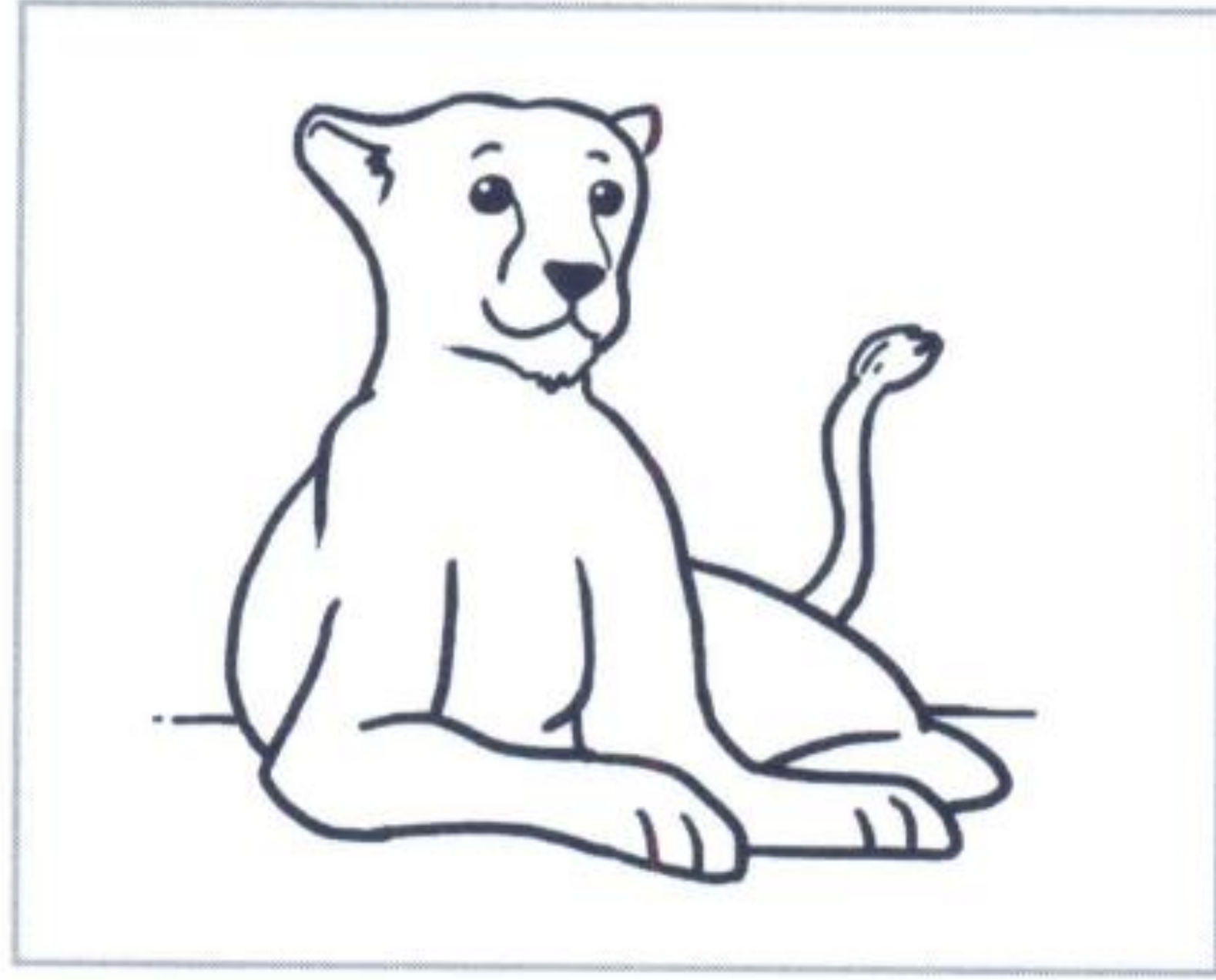

___ PARDO



RE ___ NA

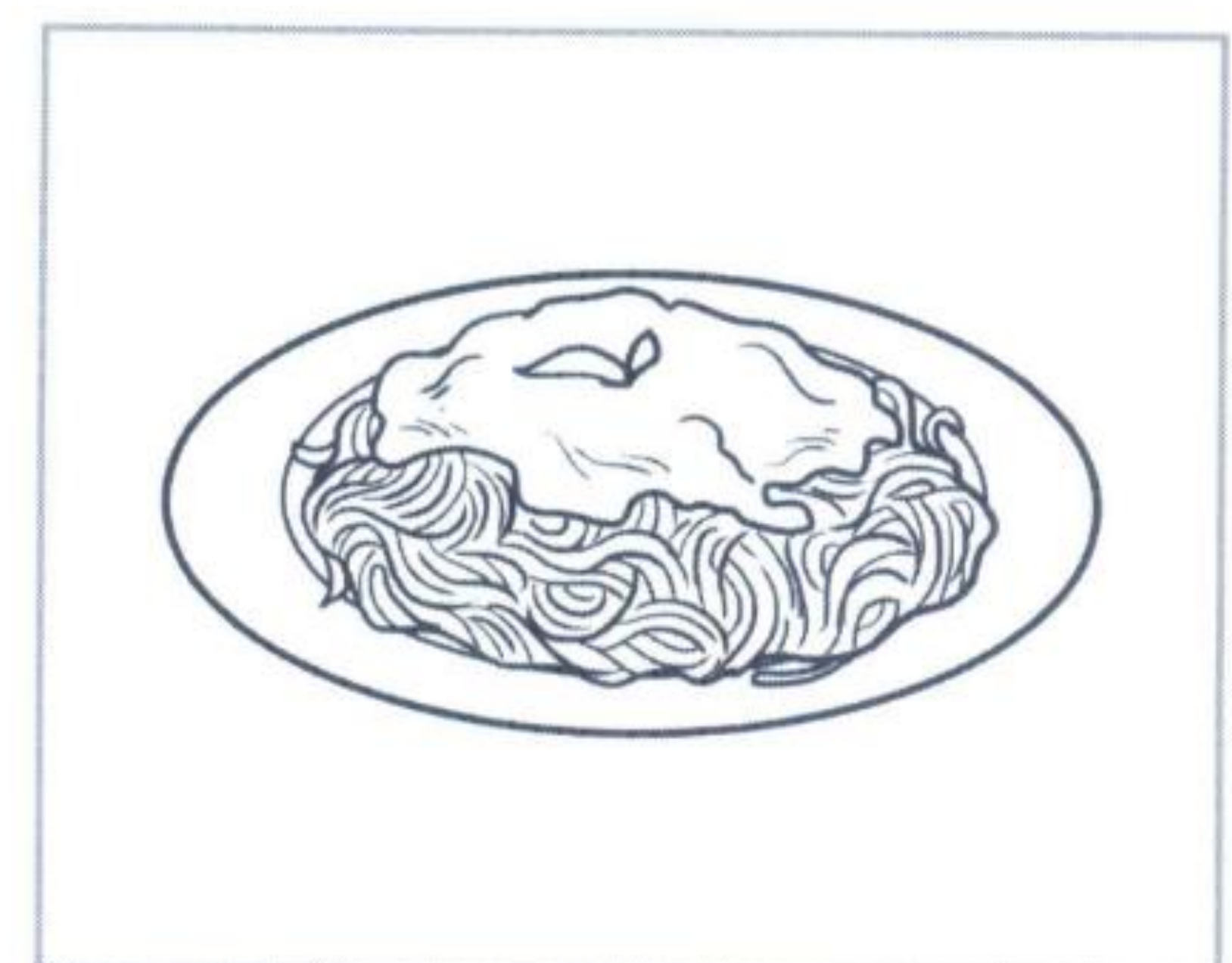

SPA ___ TTI



___ ACCA

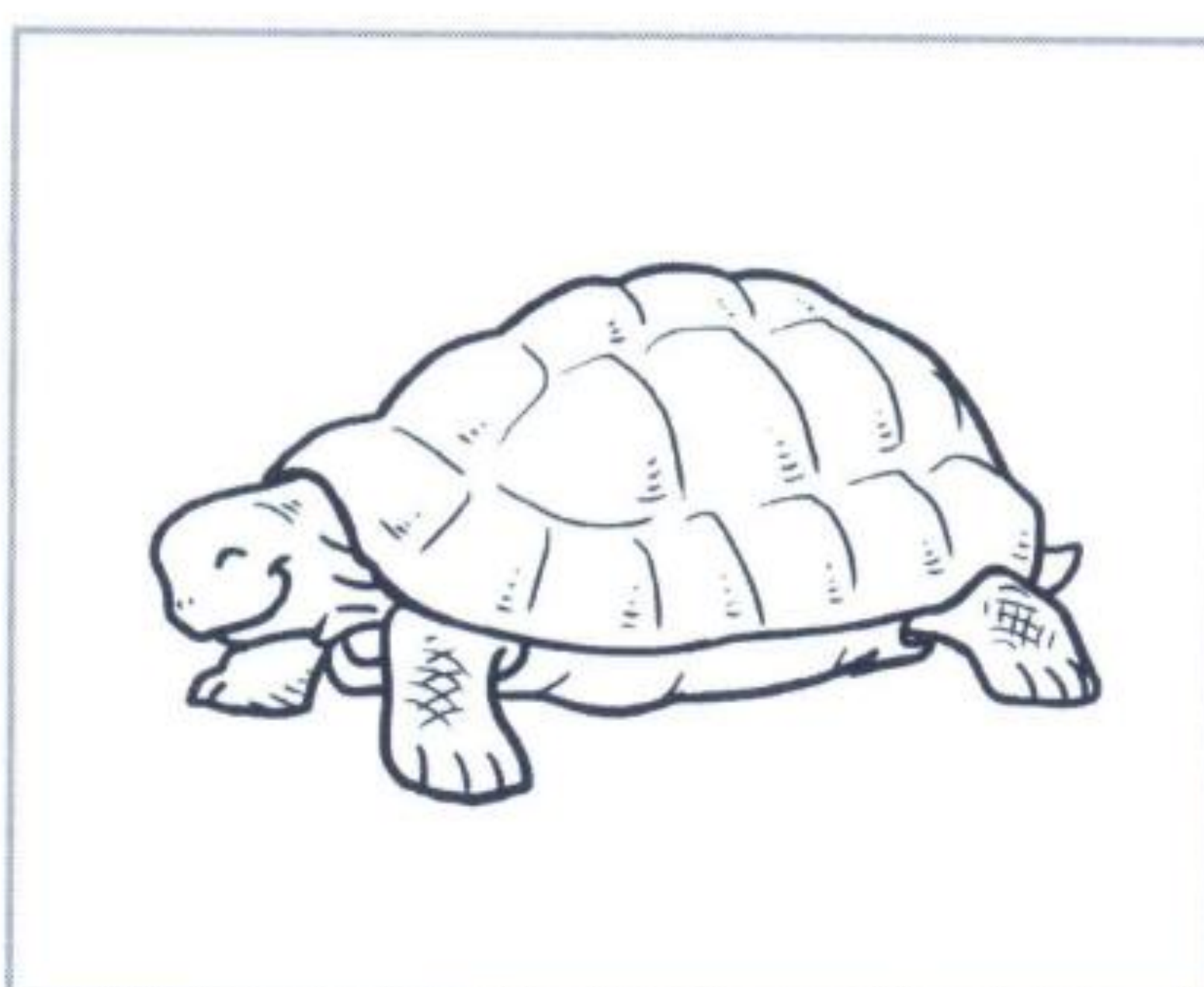

TARTARU ___



OROLO ___ O



AN ___ LO

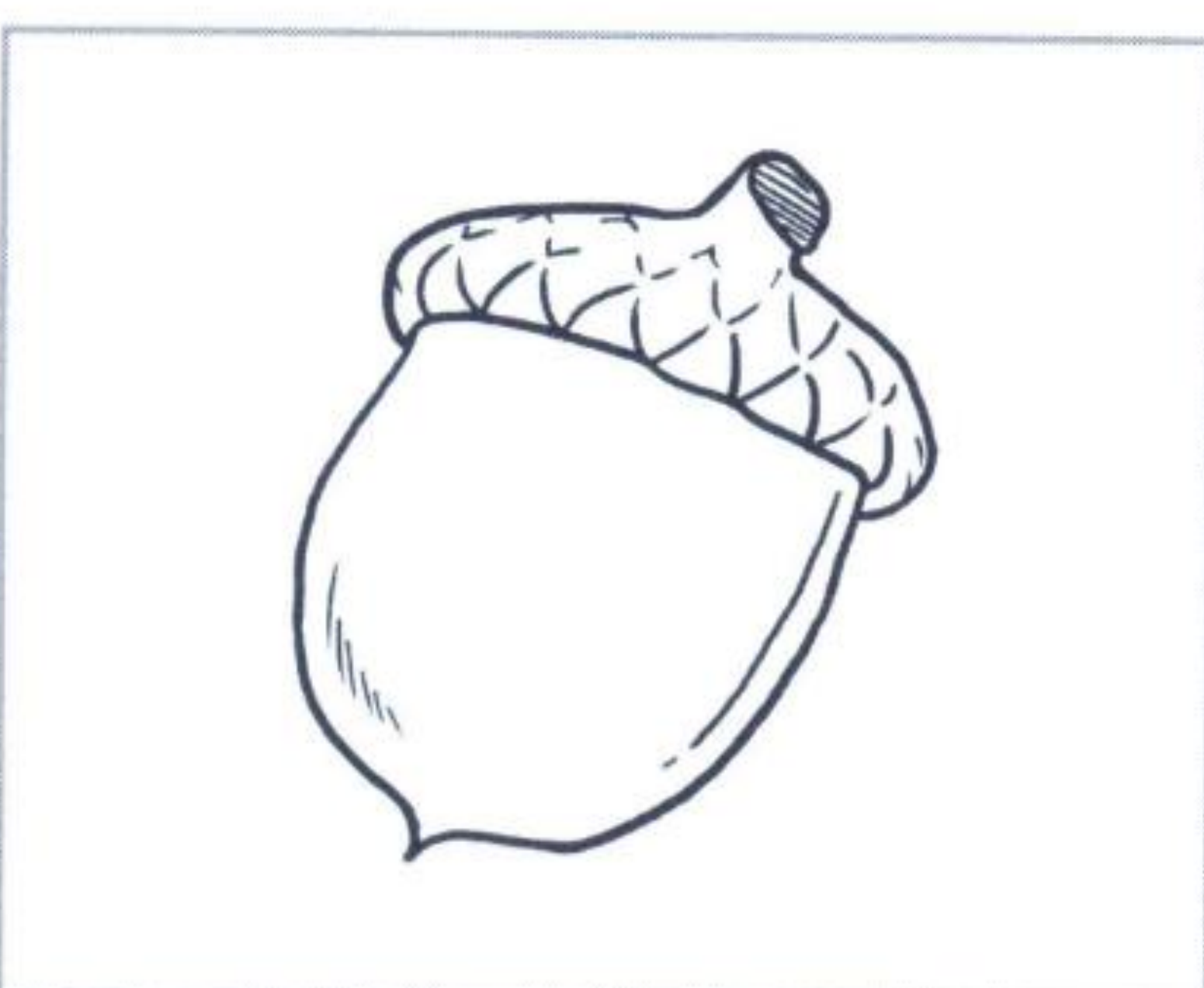

___ ANDA

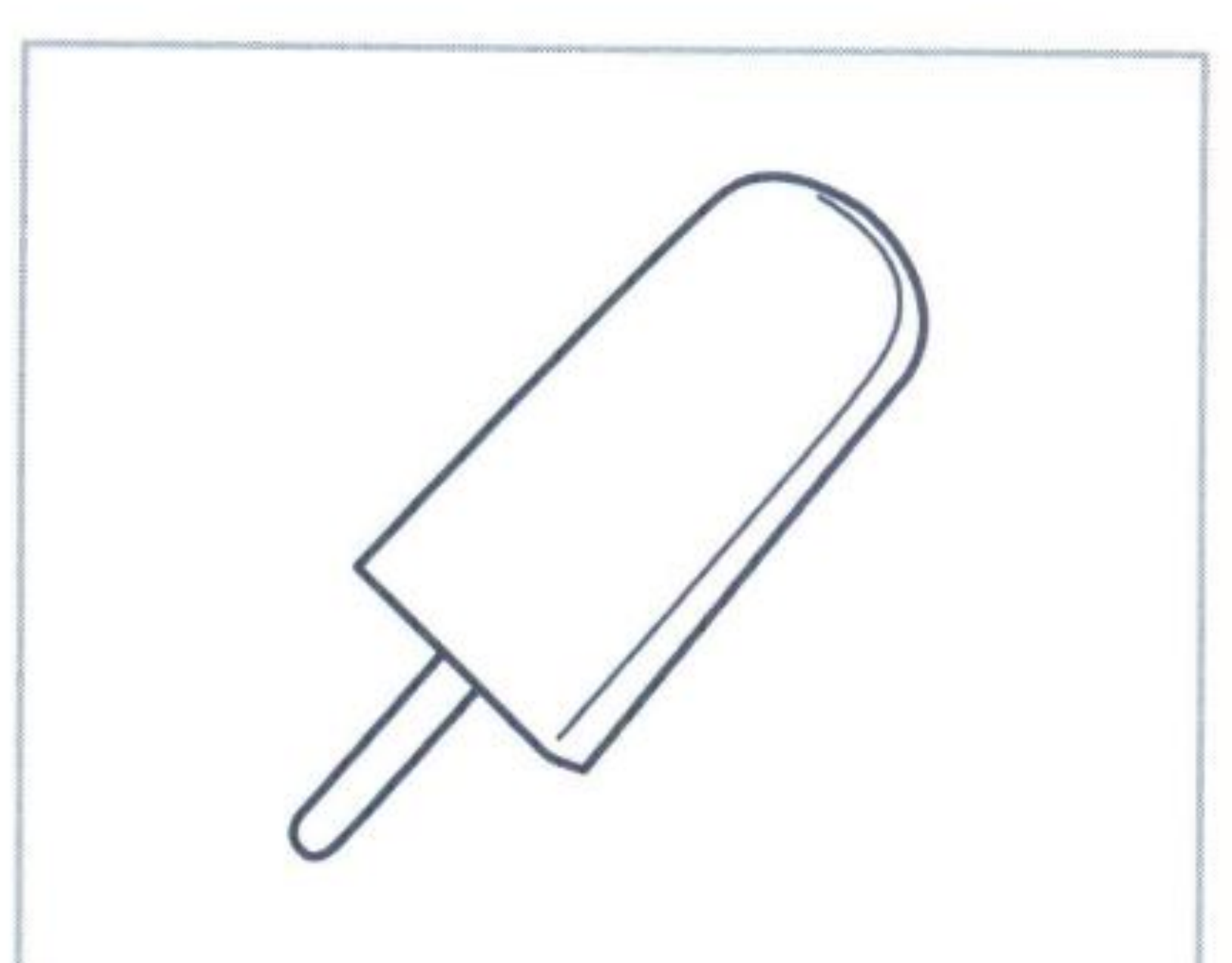

___ ACCIOLO

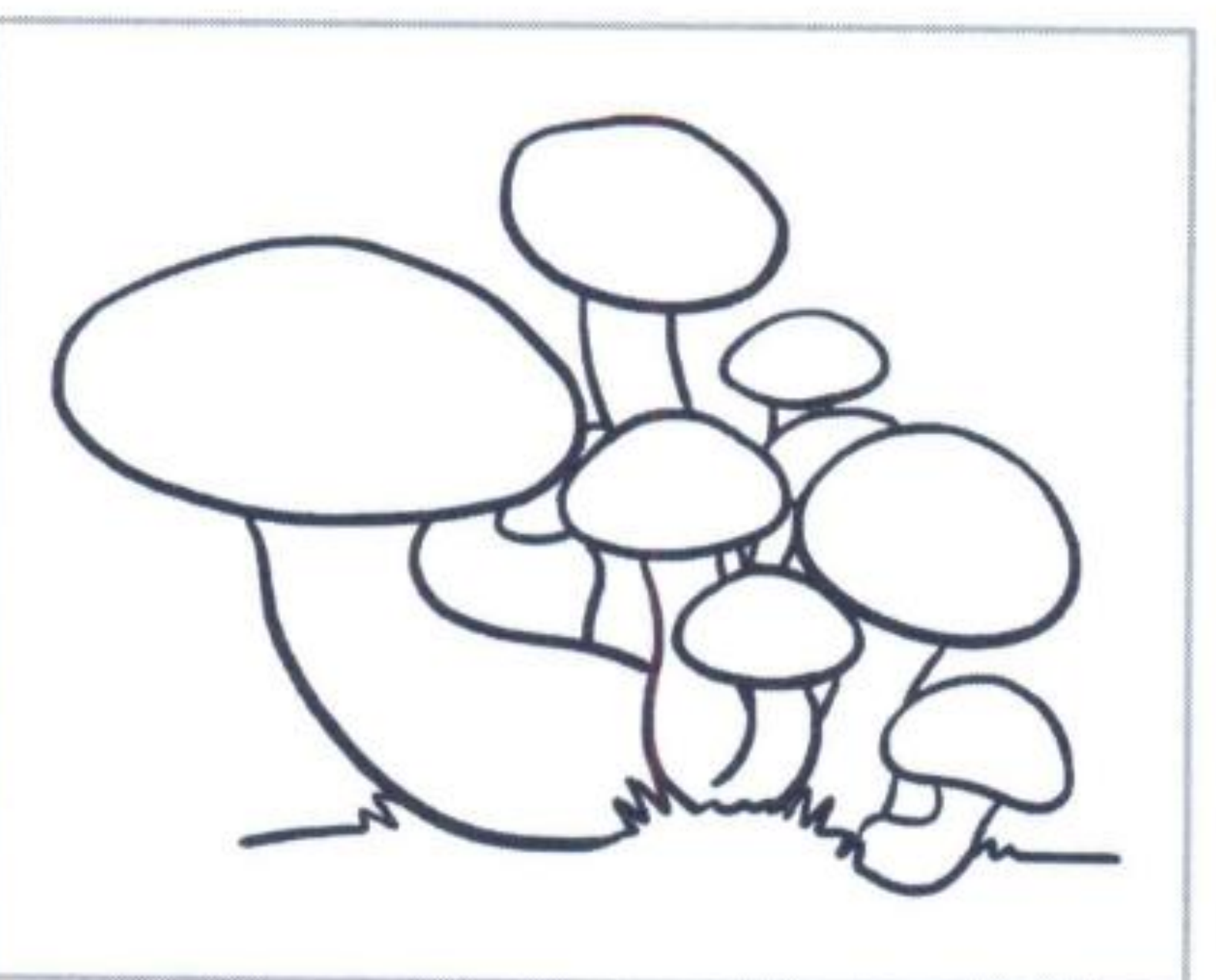

FUN ___



___ LATO

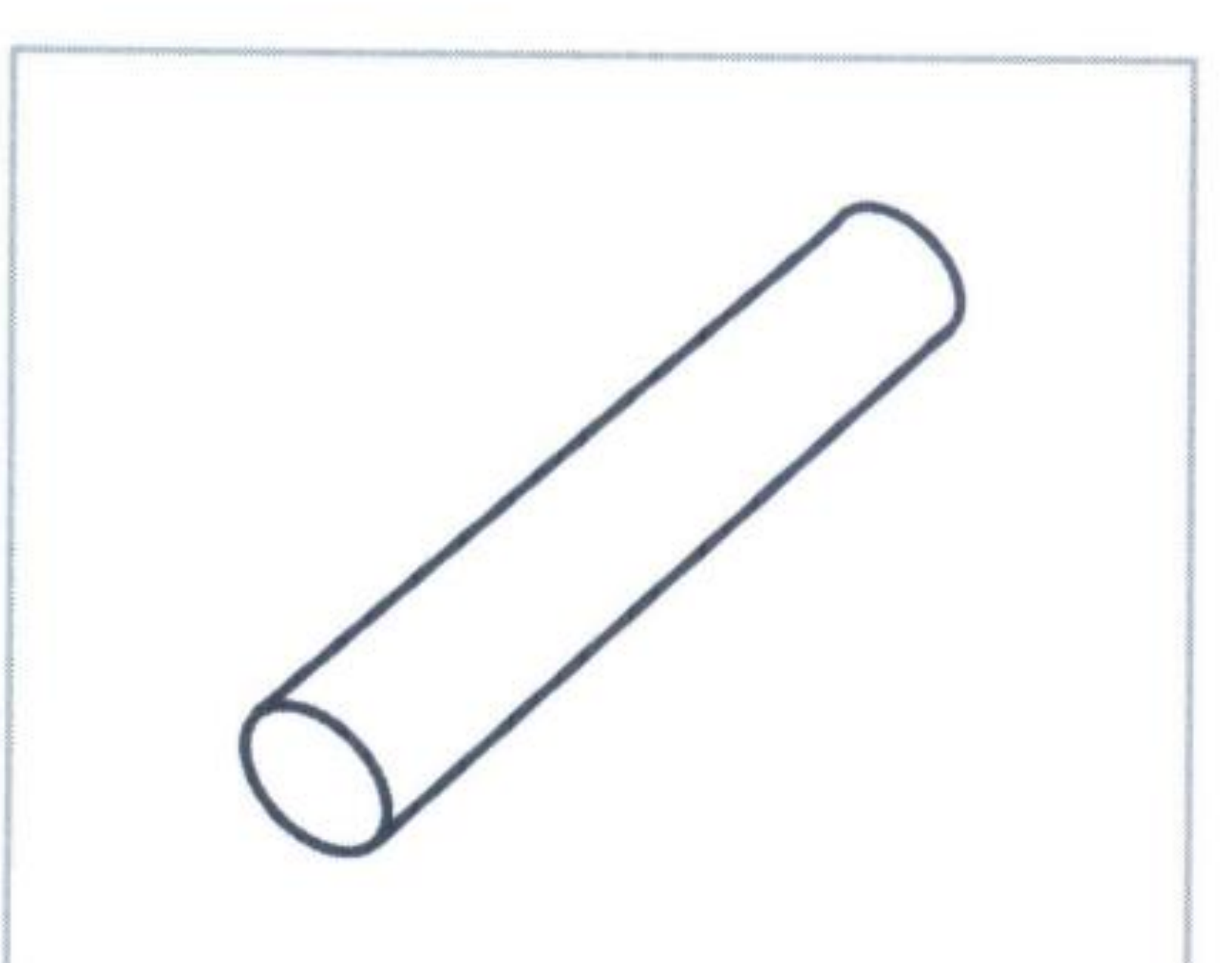

___ SSO

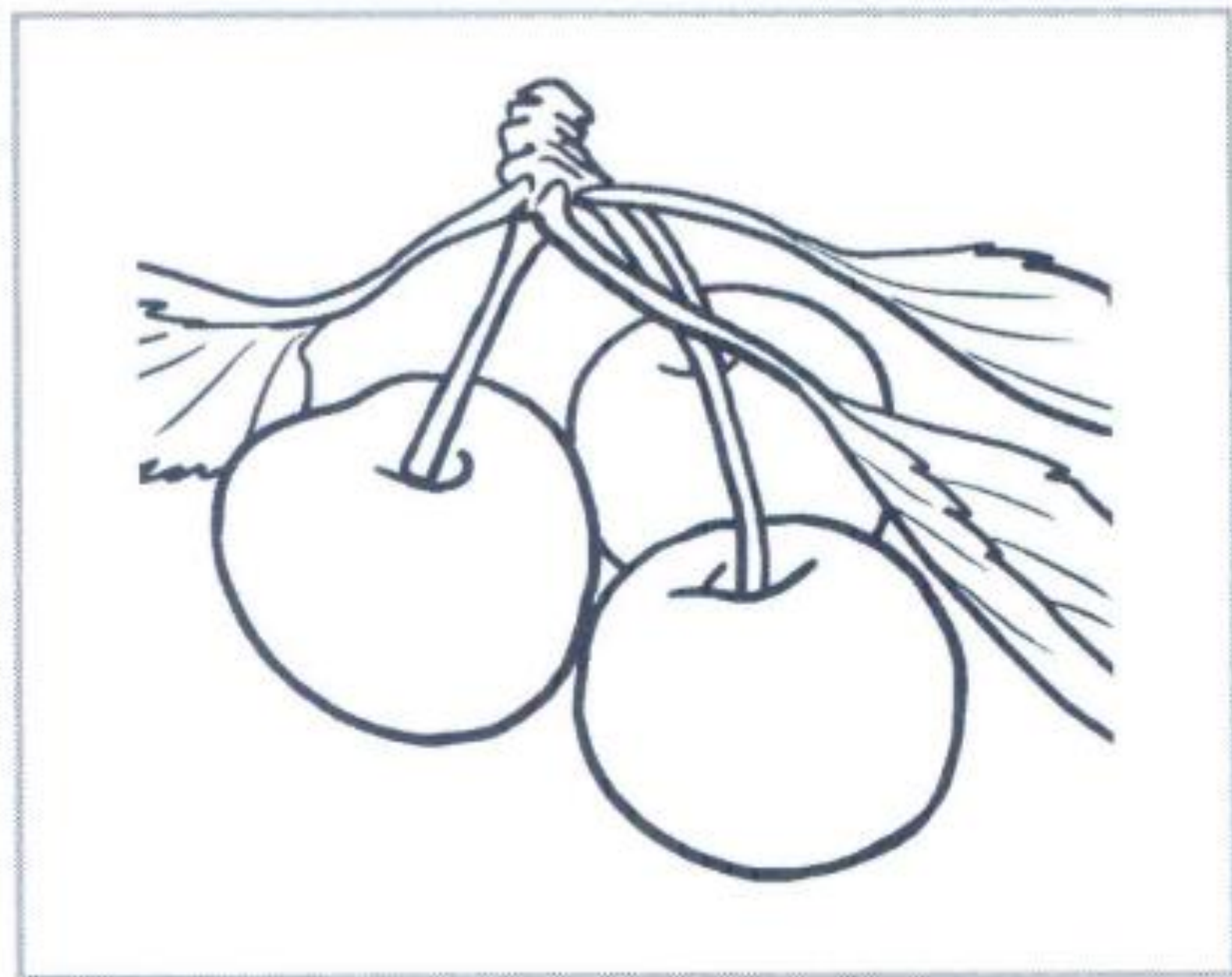

___ LIEGIE

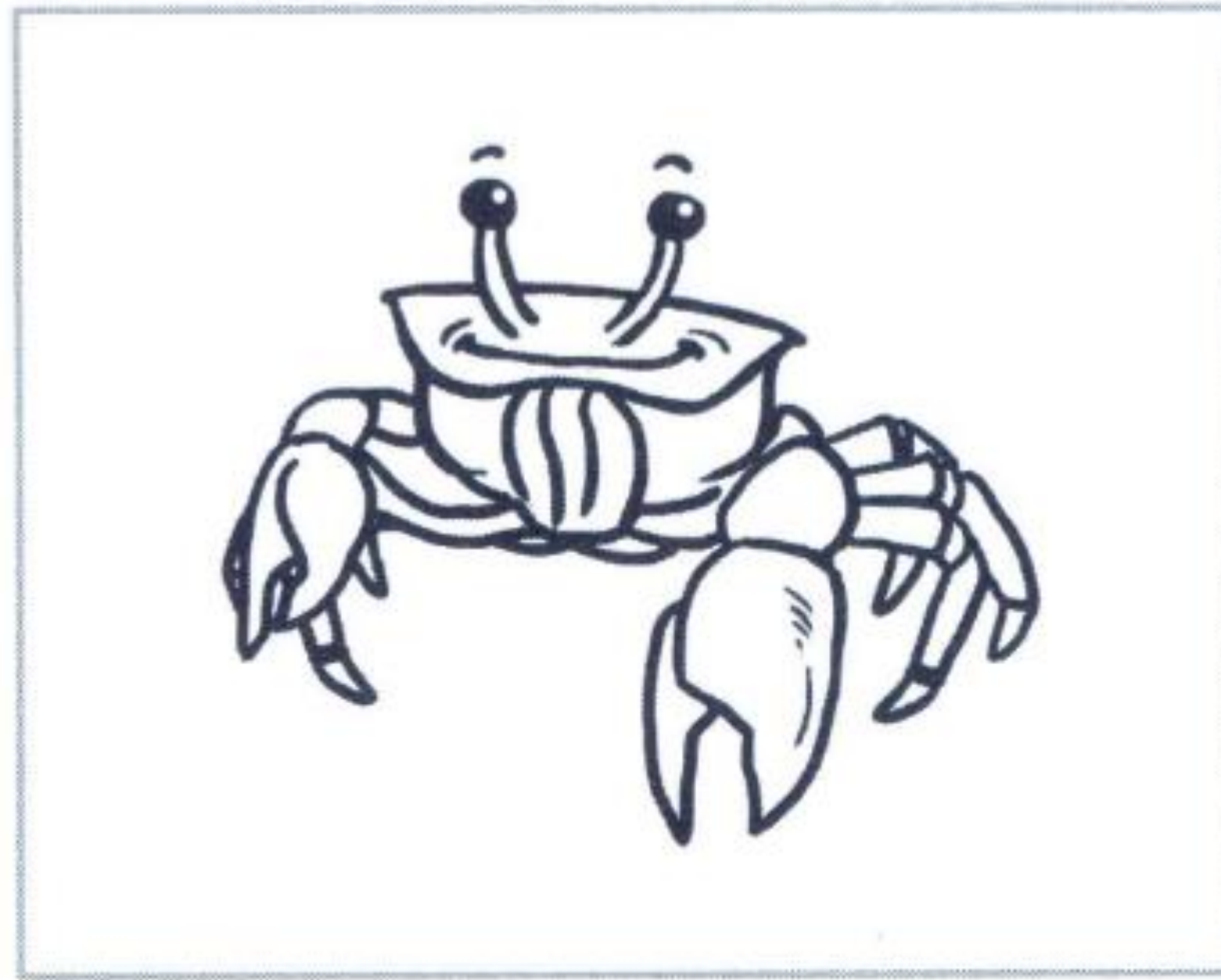

GRAN ___ O

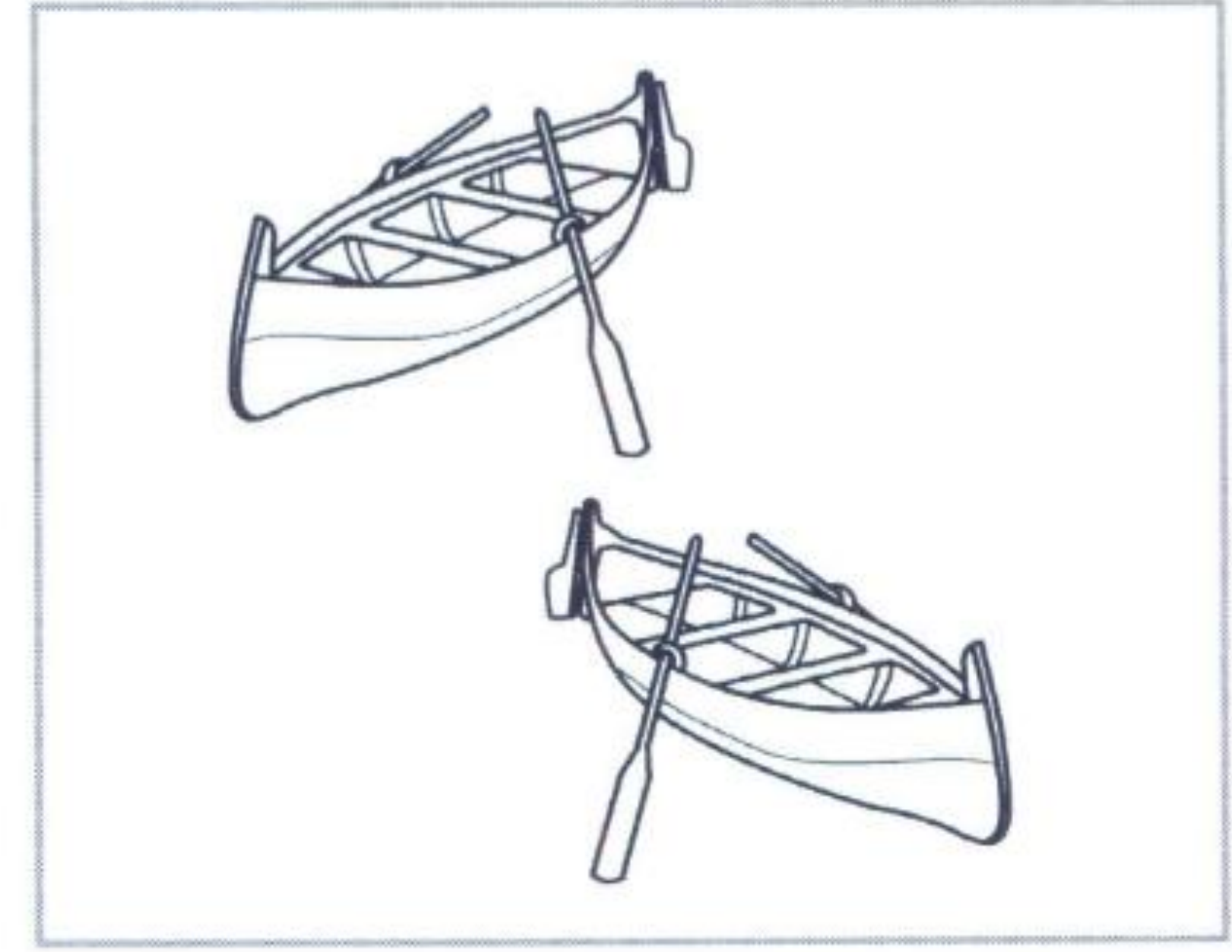

BAR ___

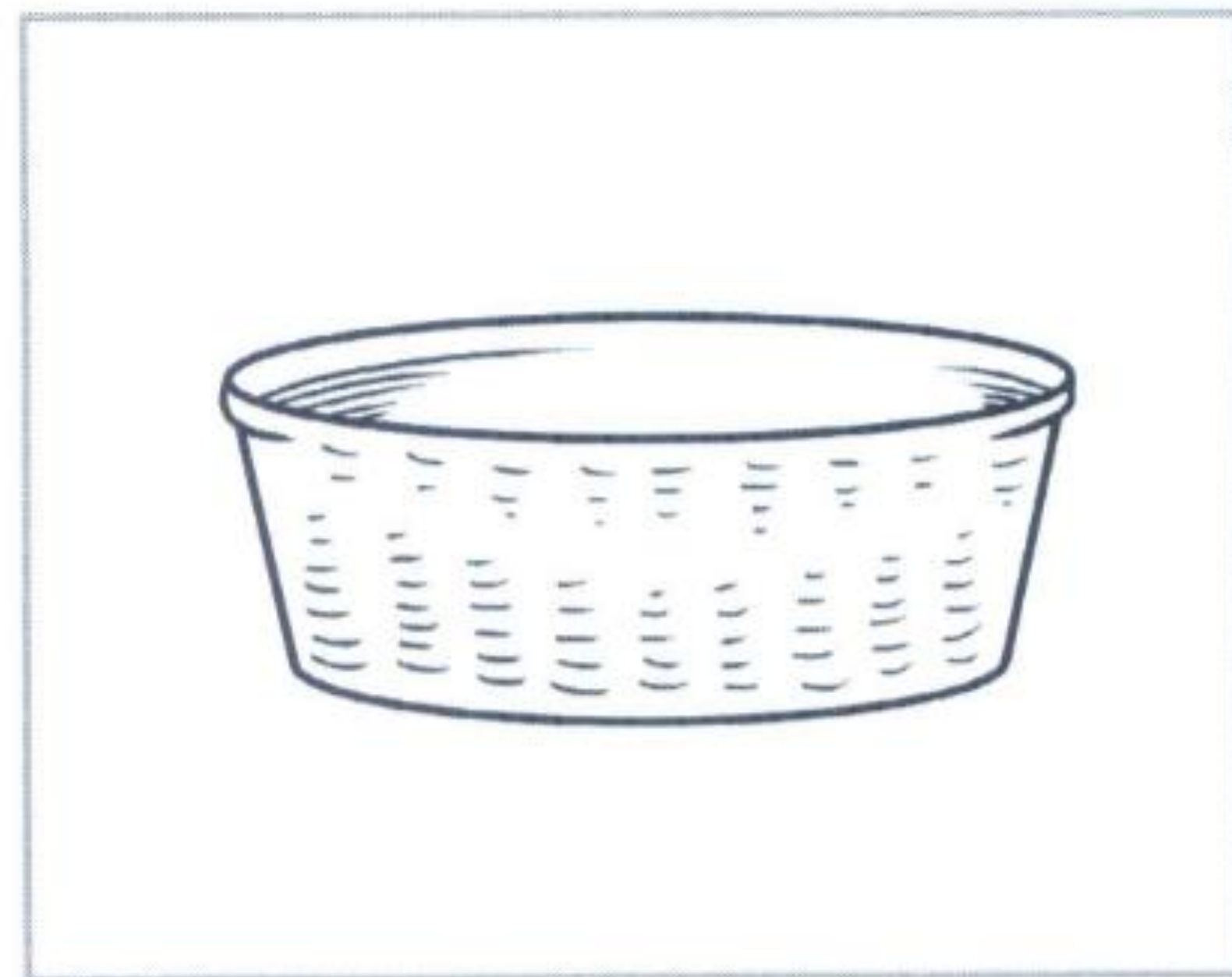

___ STO

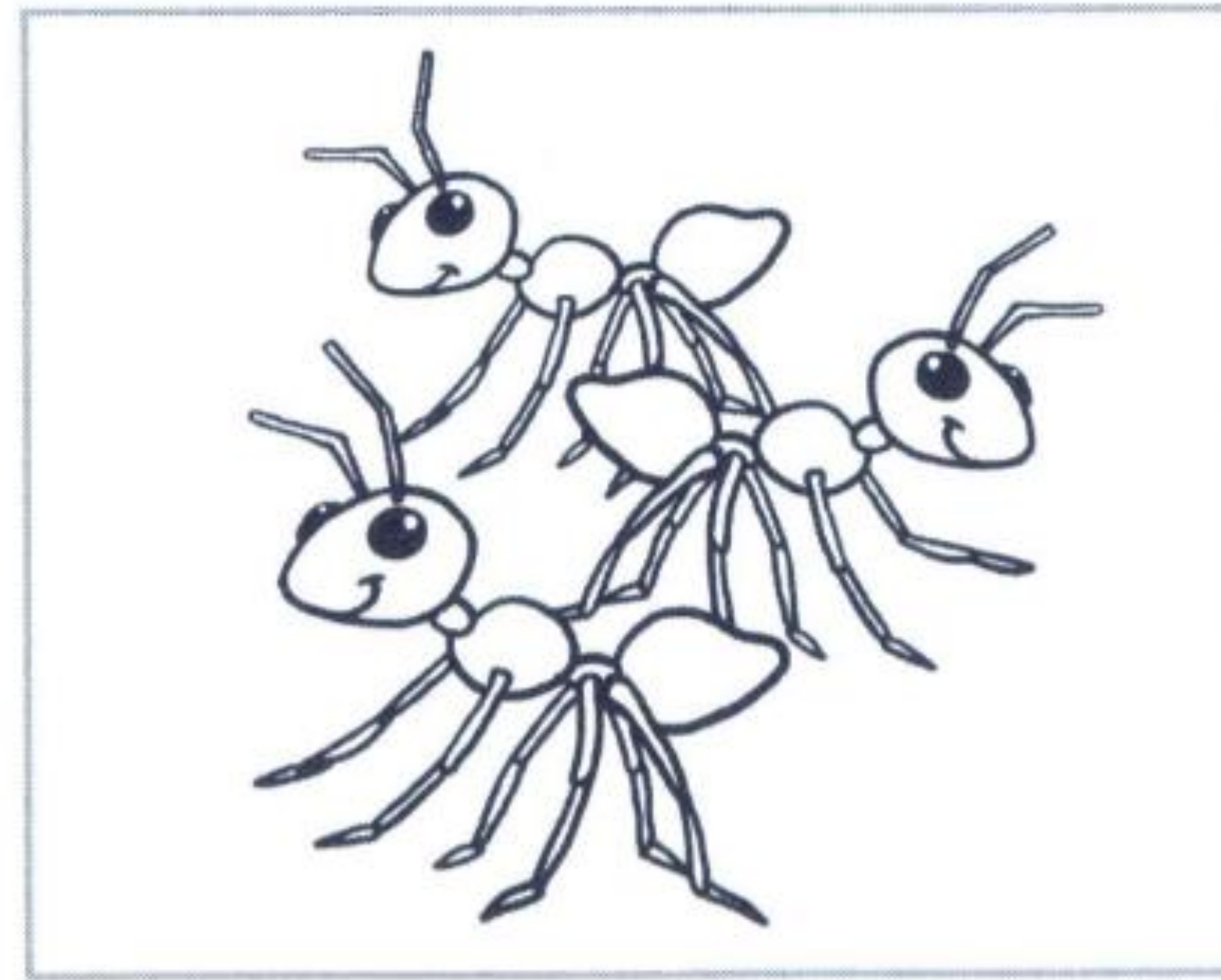

FORMI ___

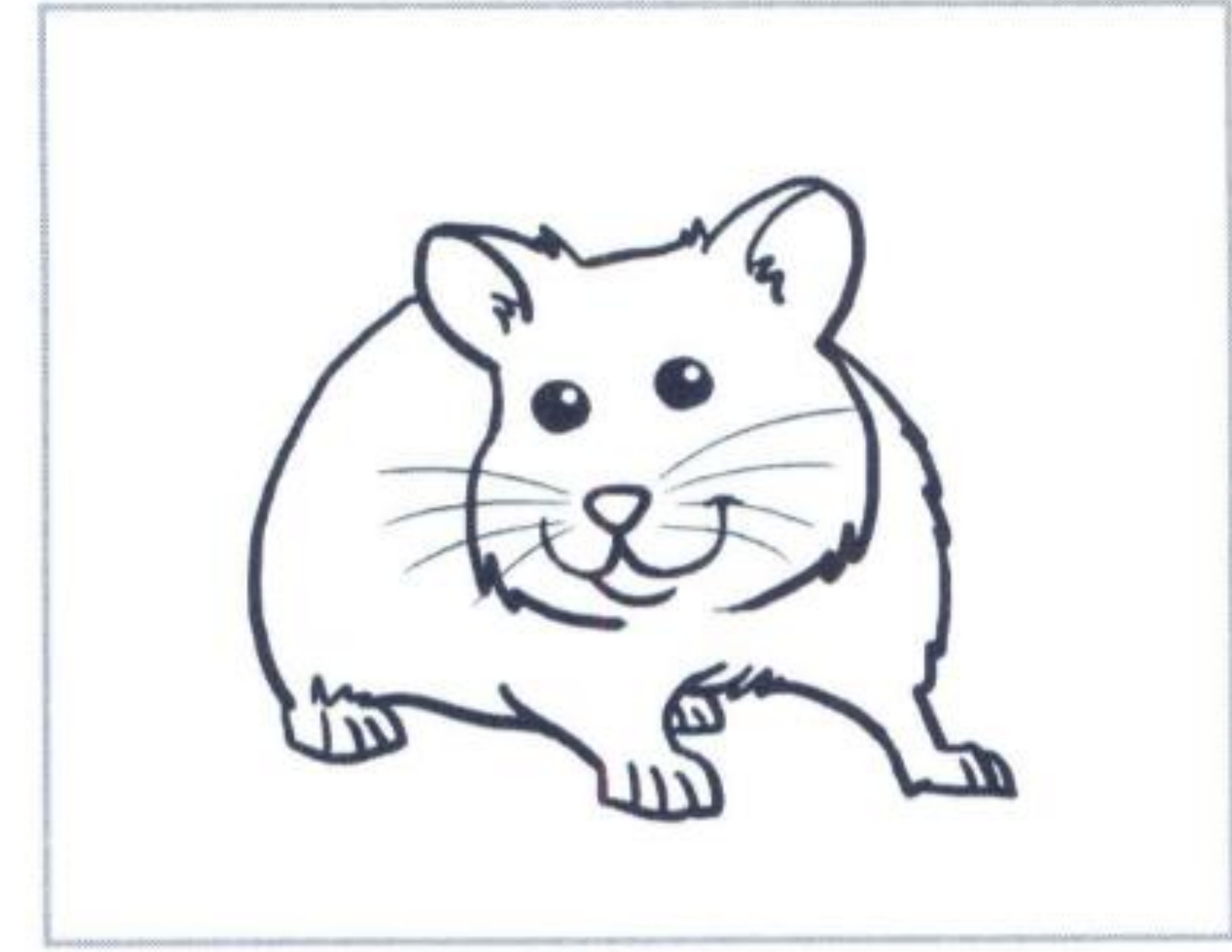

CRI ___ TO

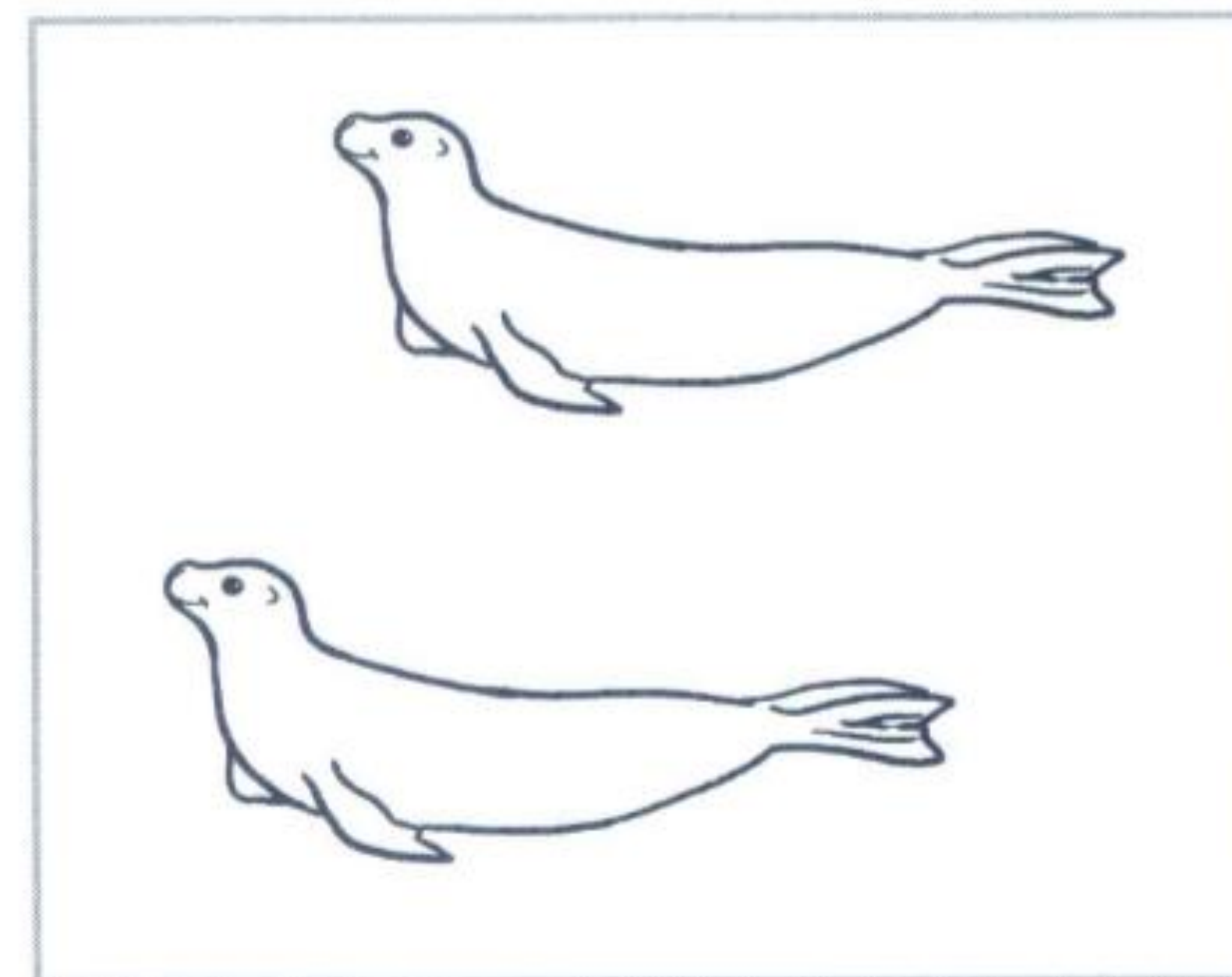

FO ___

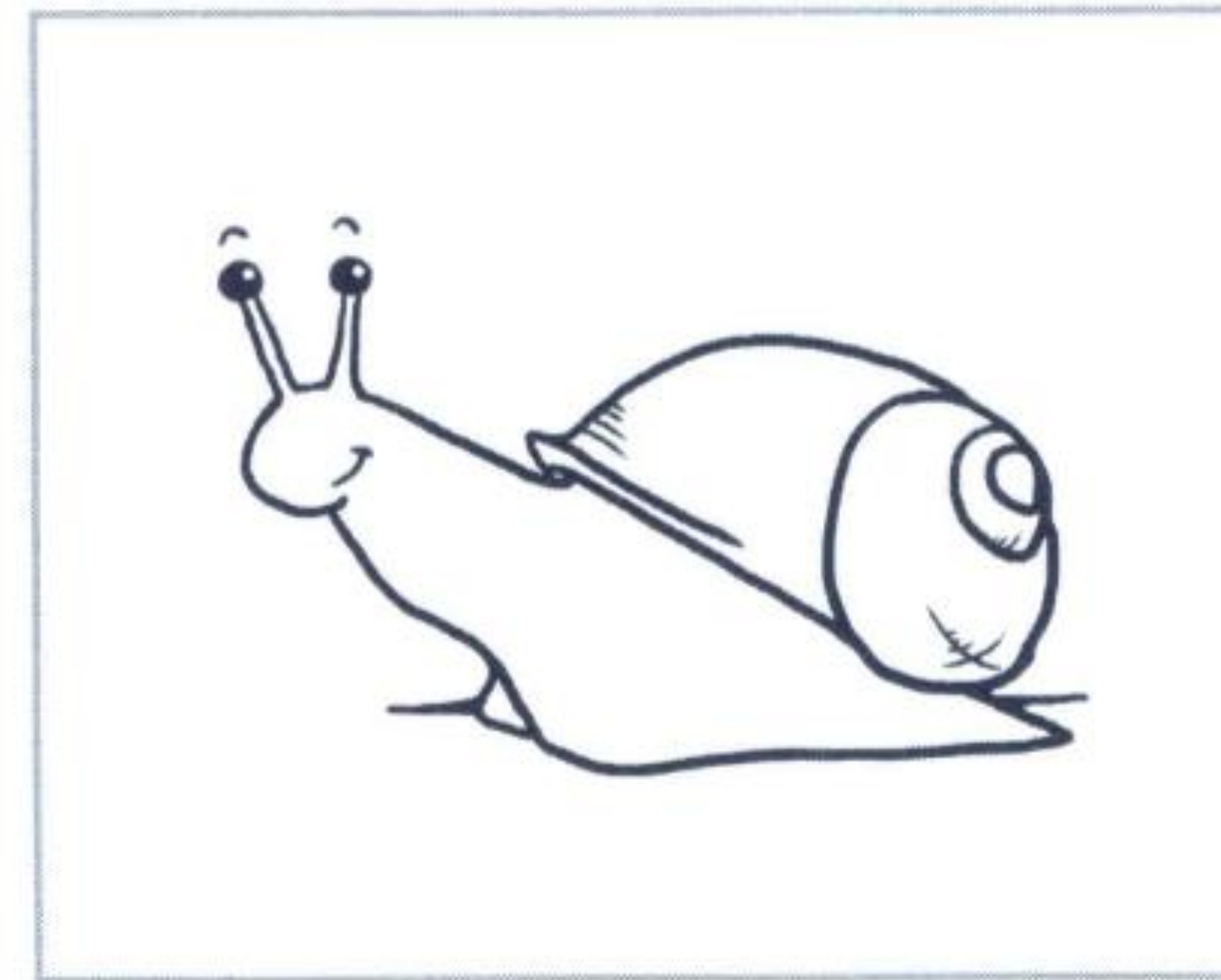

___ OCCIOLA

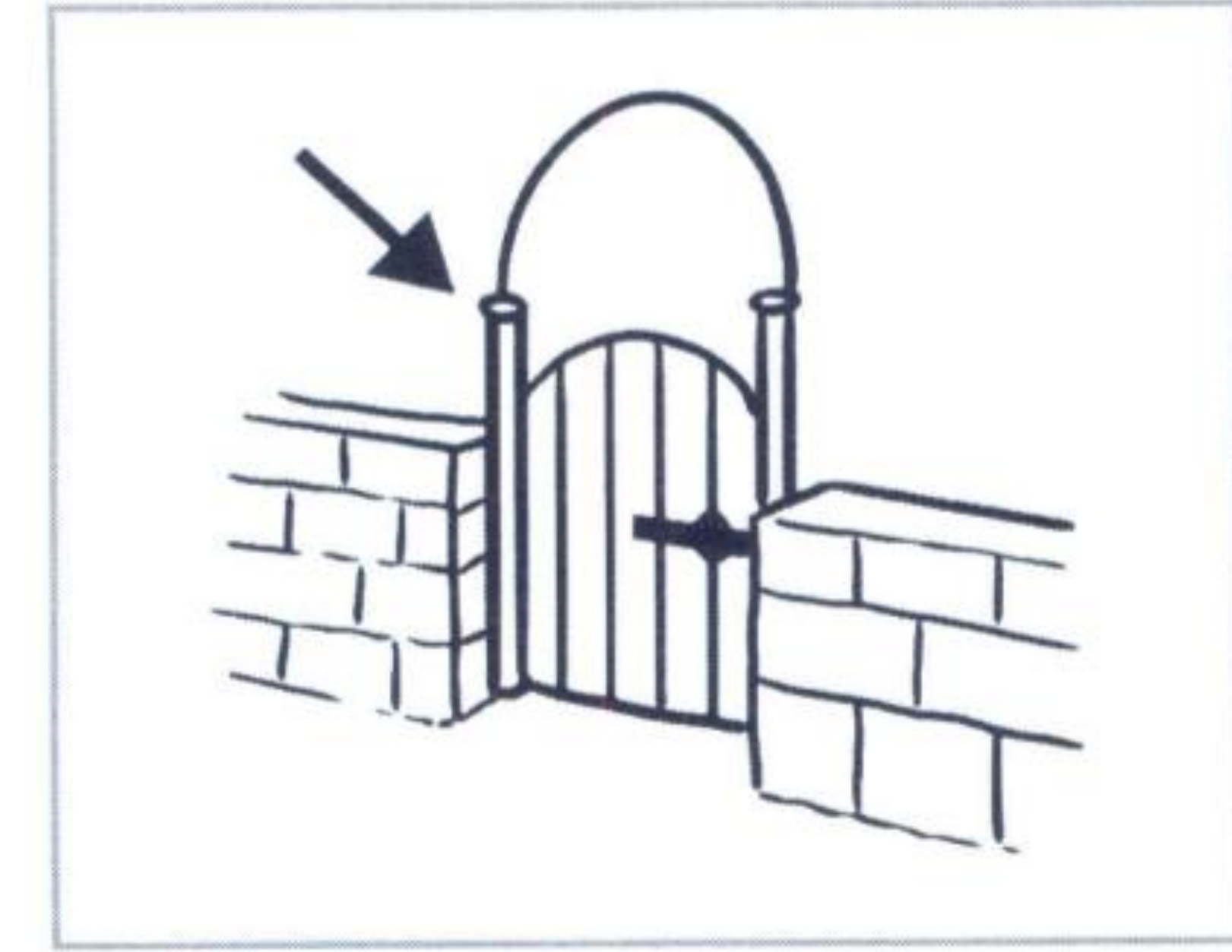

CAN ___ LLO

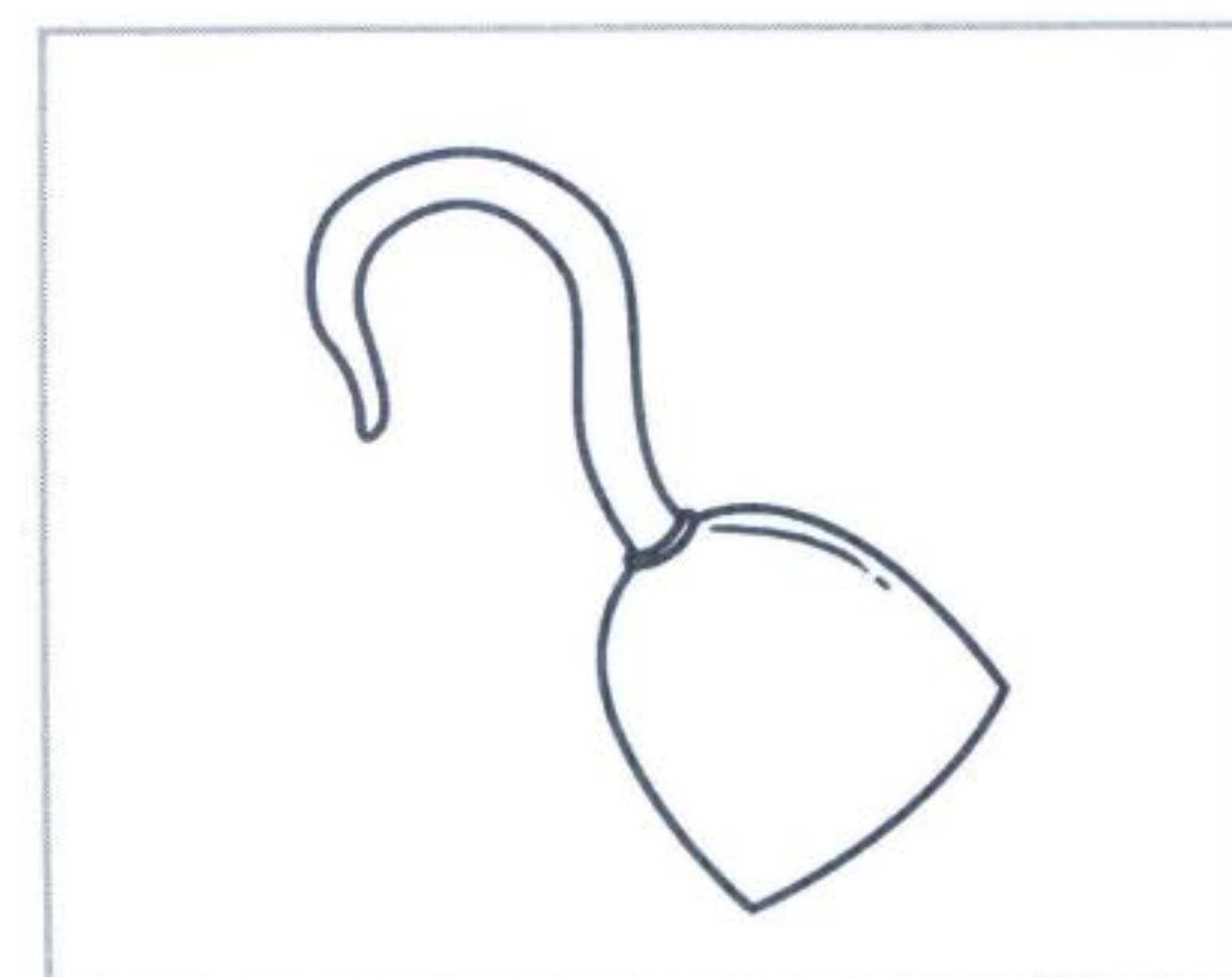

UN ___ NO

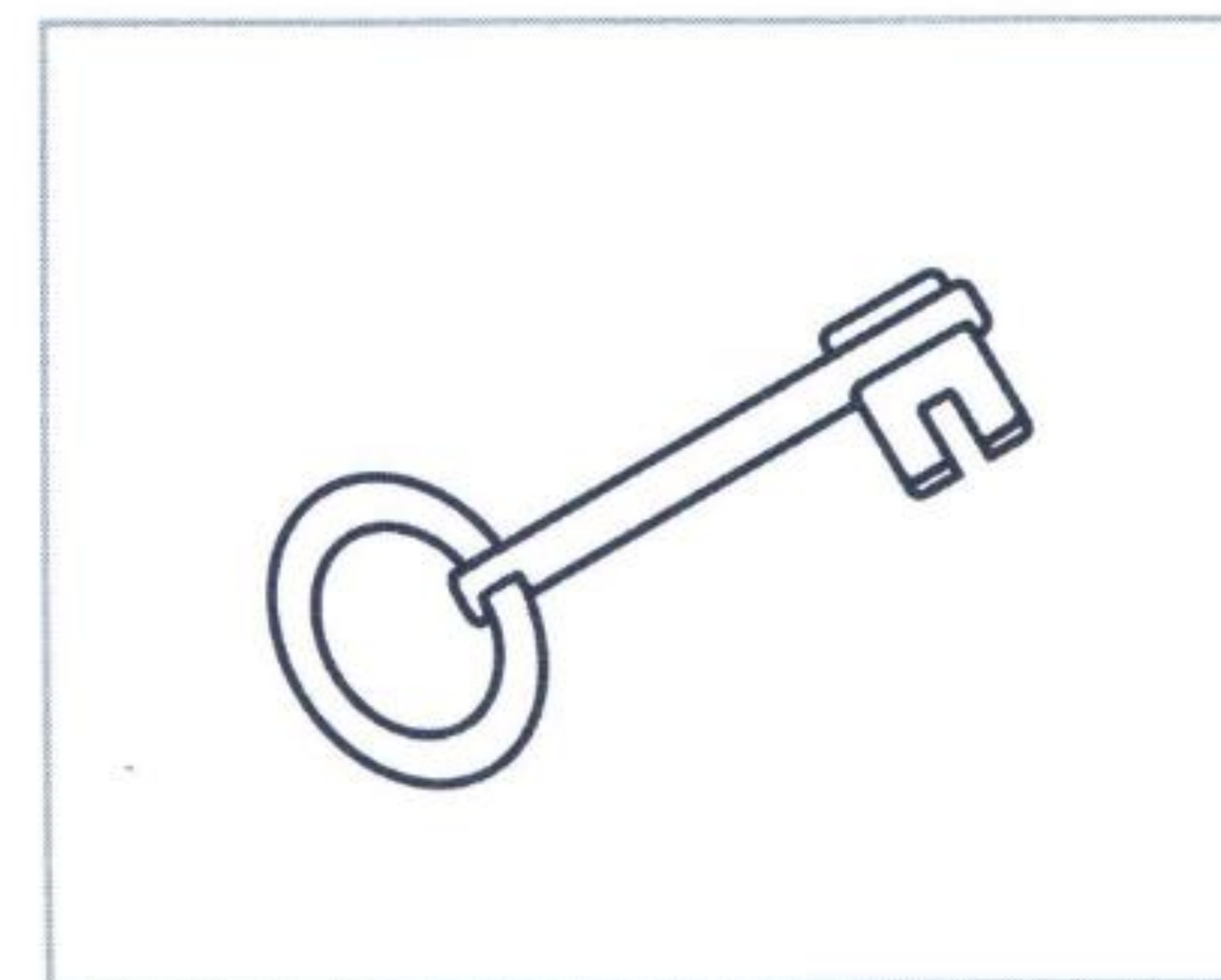

___ AVE

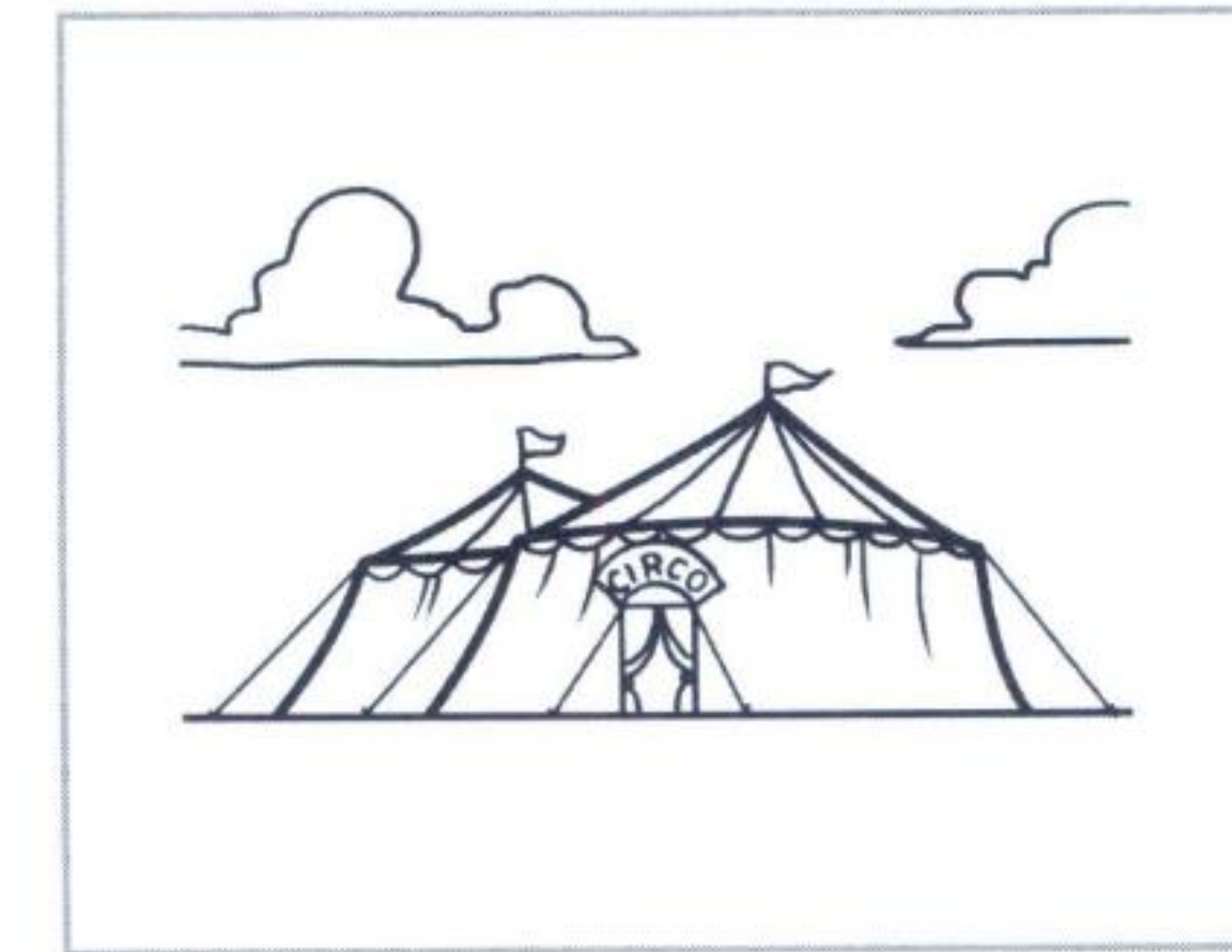

___ RCO



COMPLETA LE PAROLE INSERENDO «GNA», «GNE»,
«GNI» O «GNO»

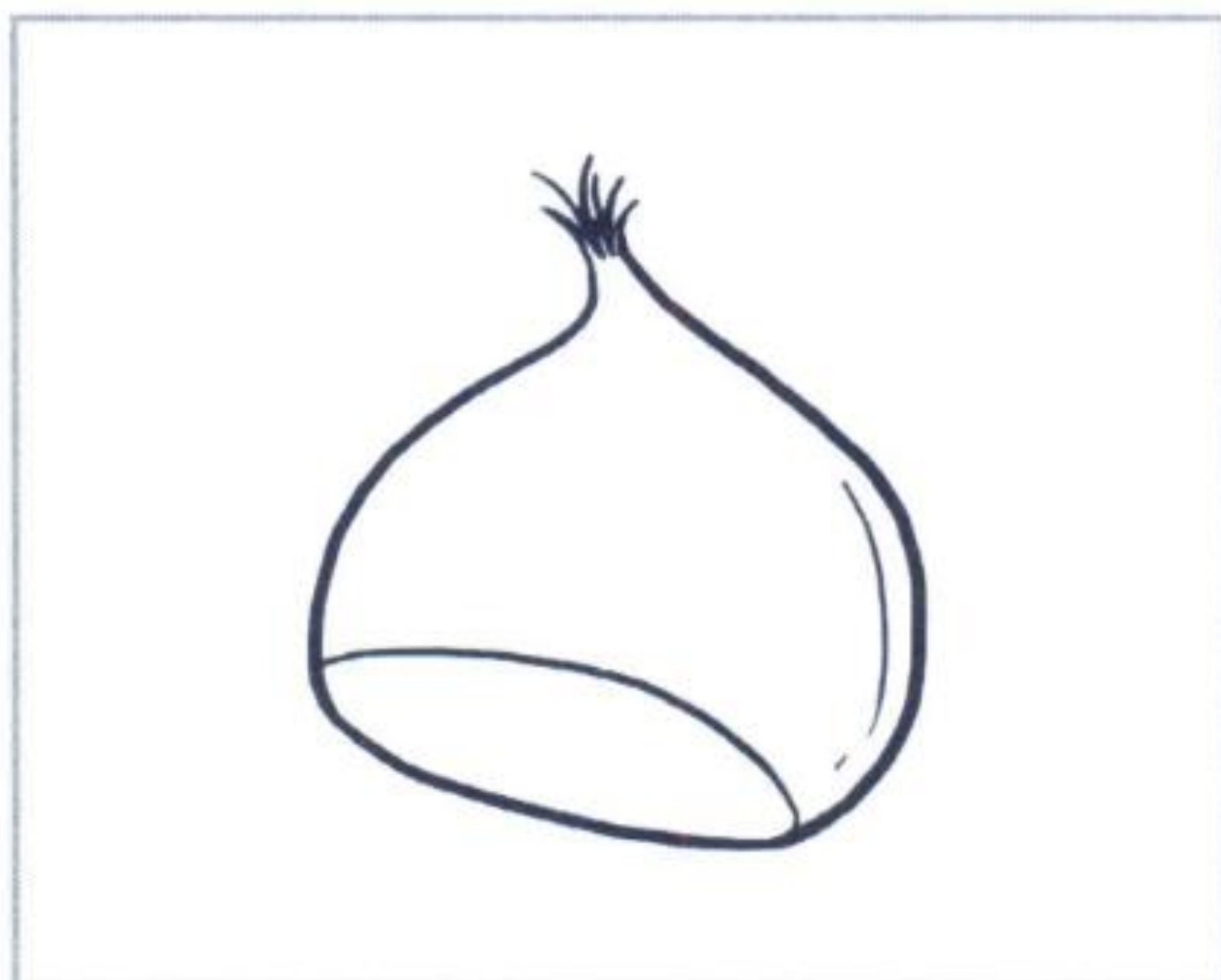

CASTA ____

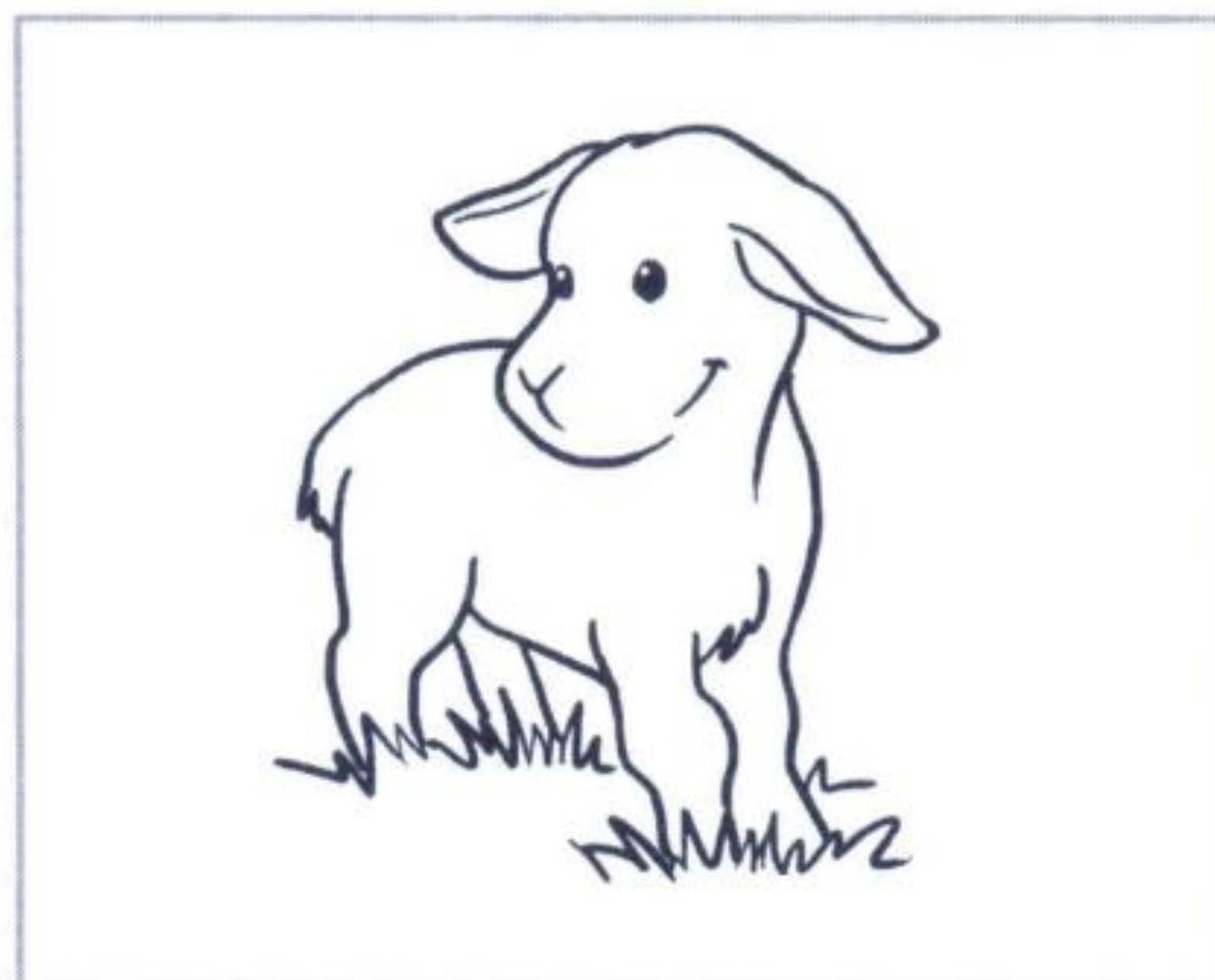

A ____ LLO



CA ____ LINO

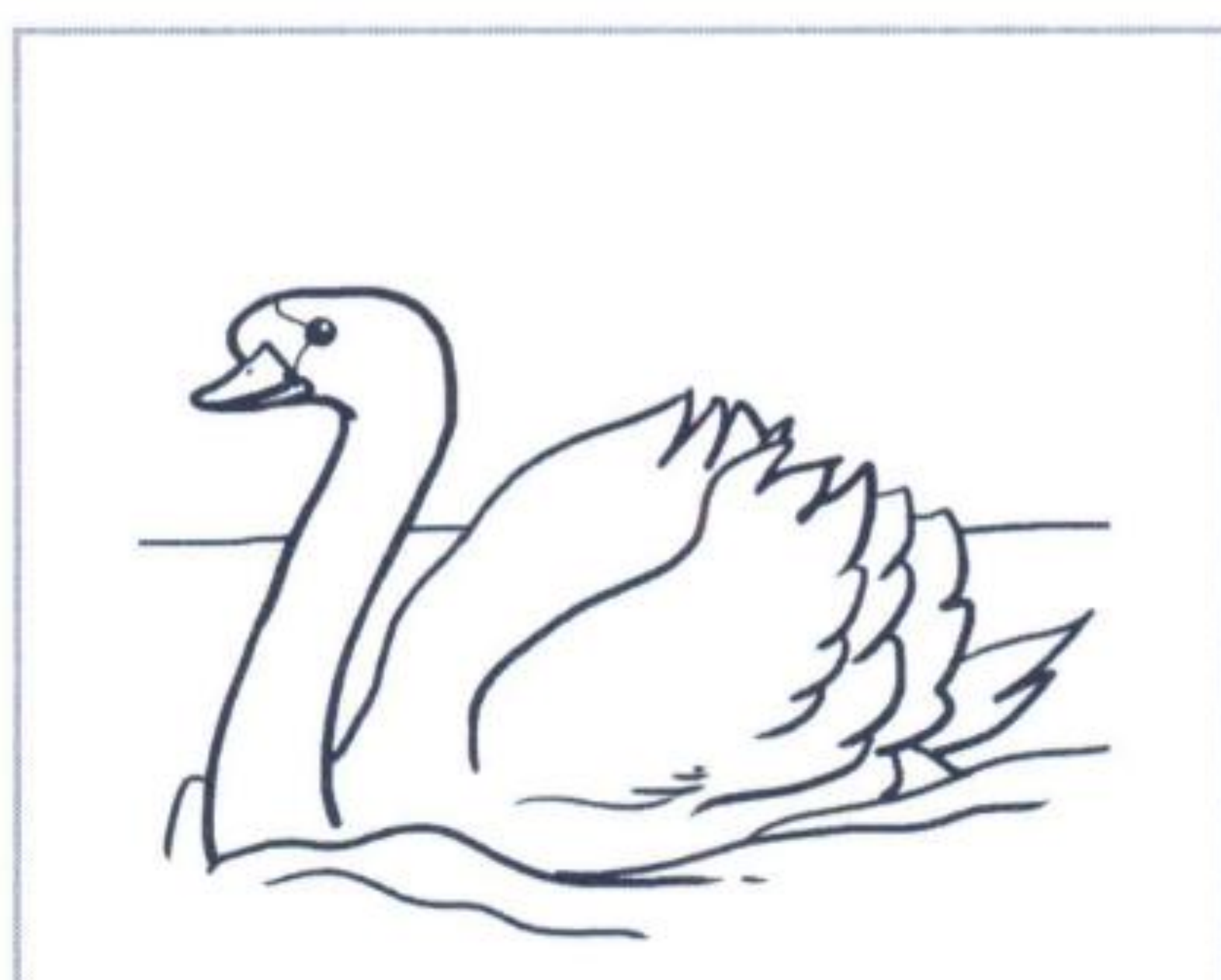

CI ____

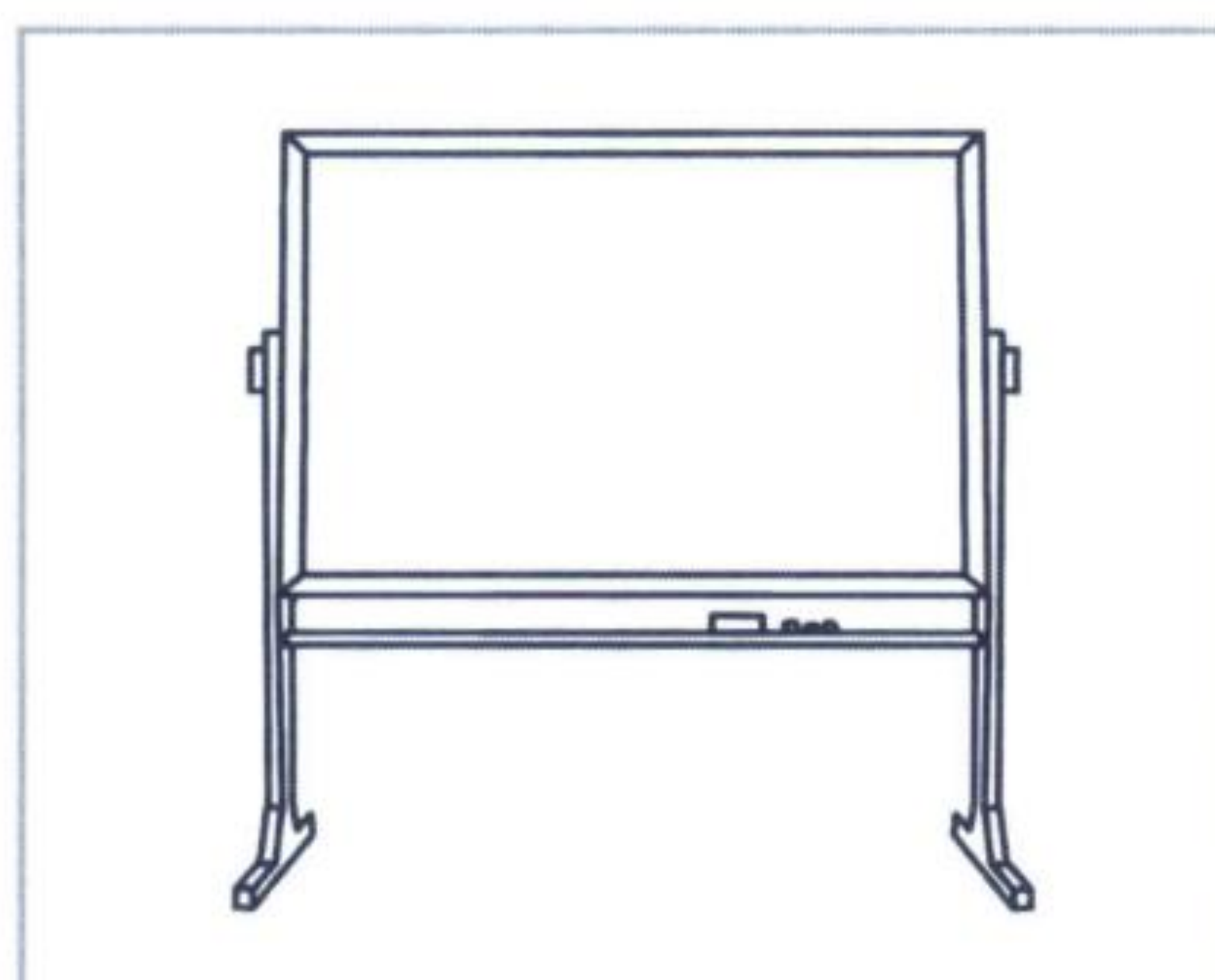

LAVA ____



MONTA ____

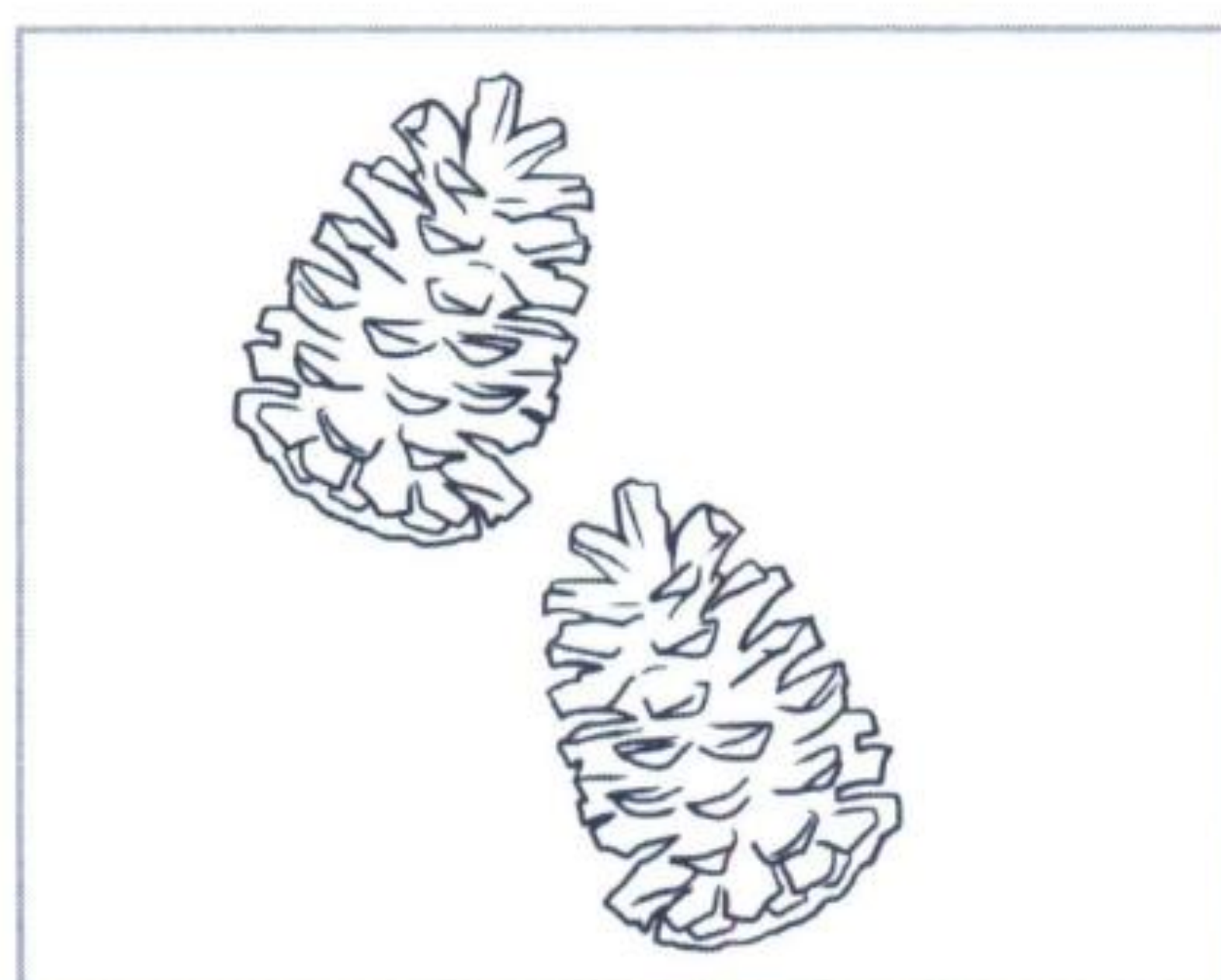

PI ____

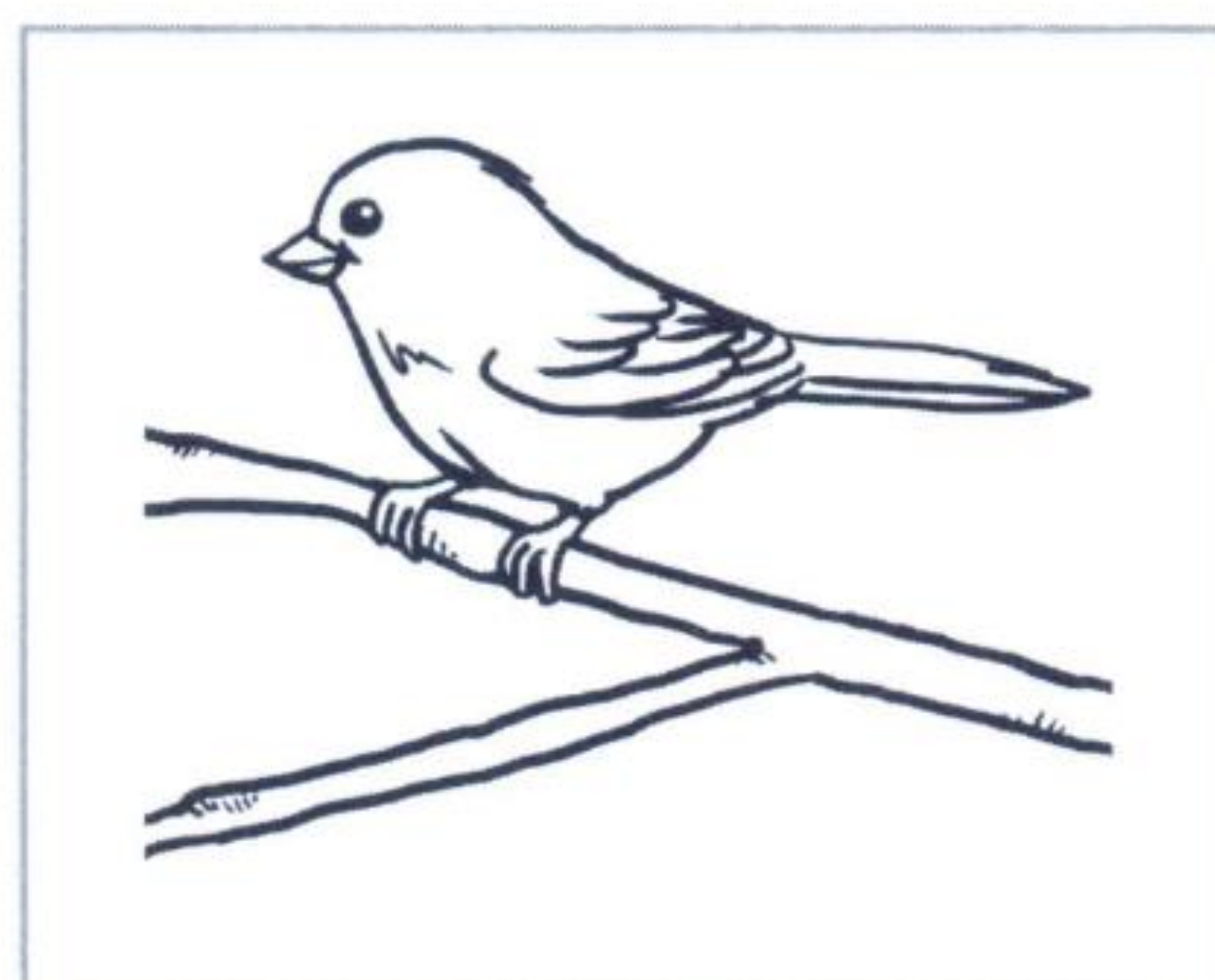

USI ____ LO

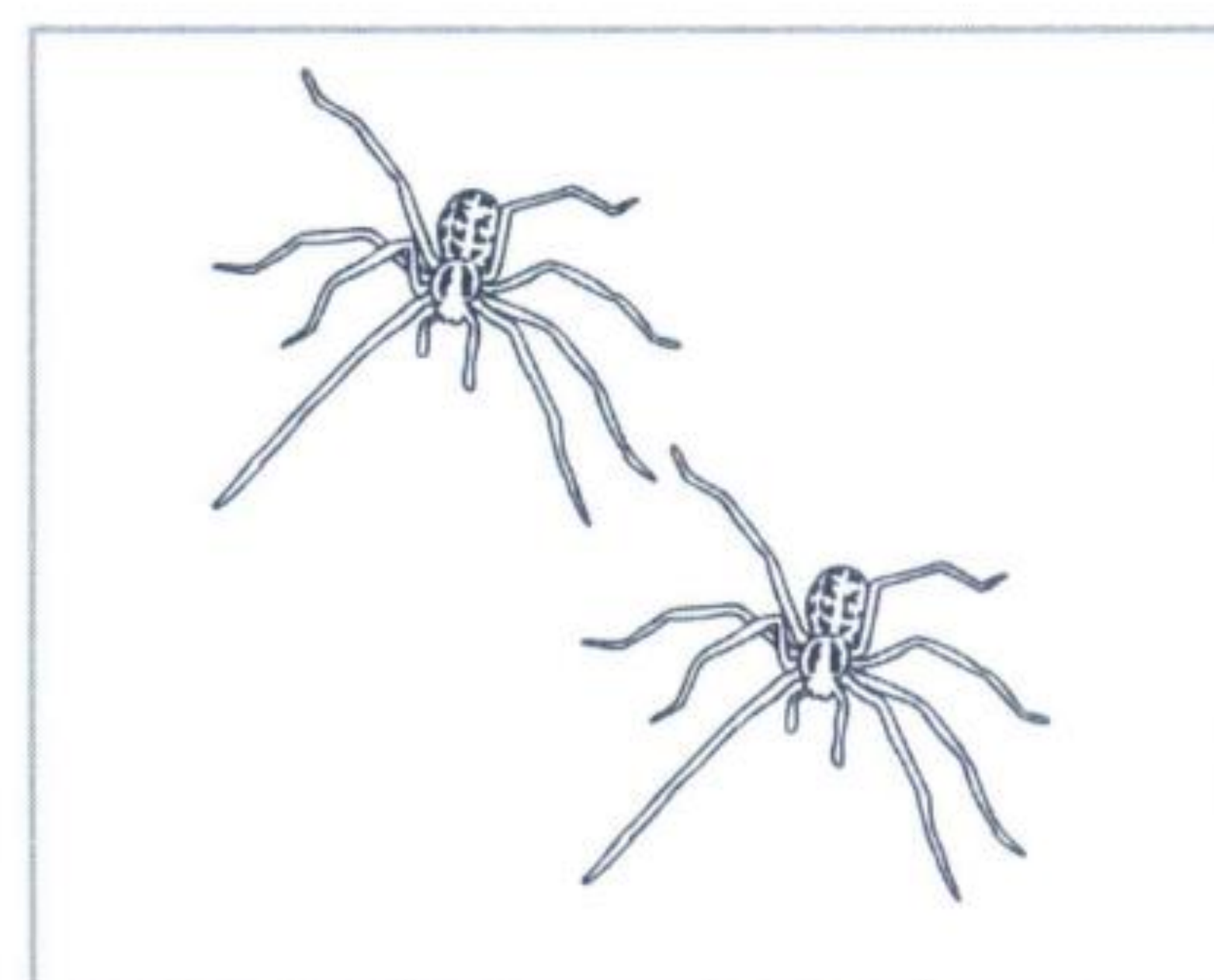

RA ____

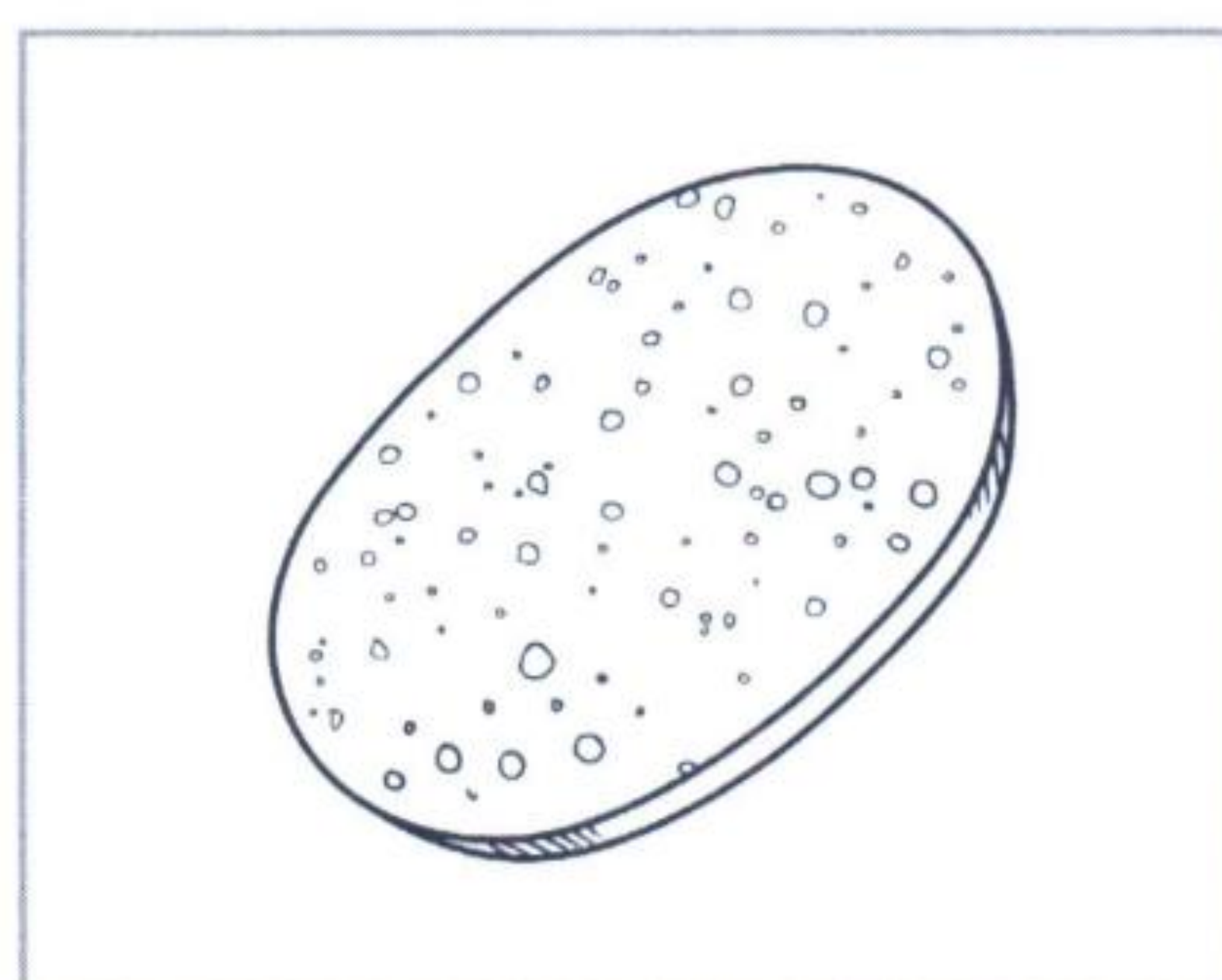

SPU ____



____ MO

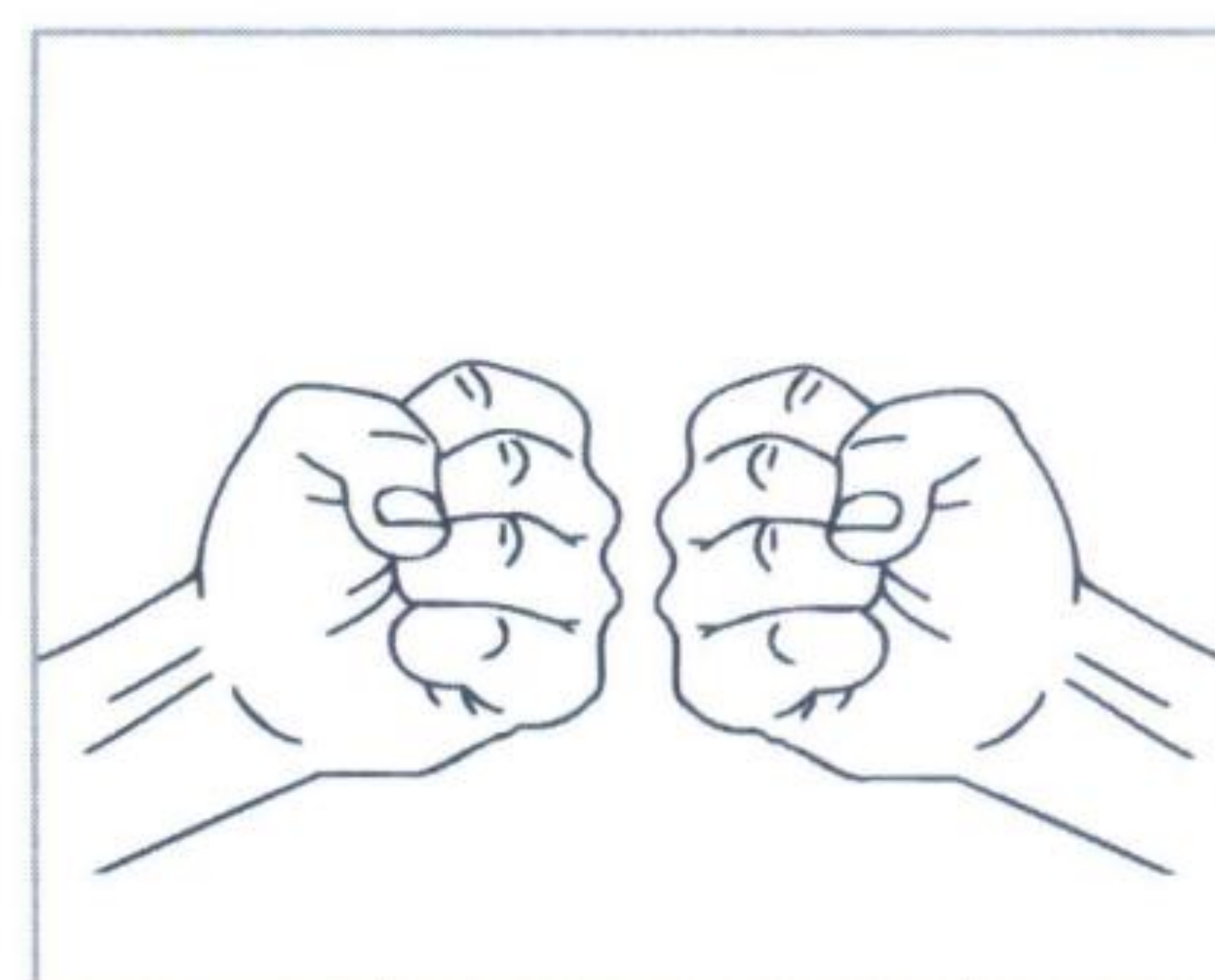

PU ____



___ RIFFO

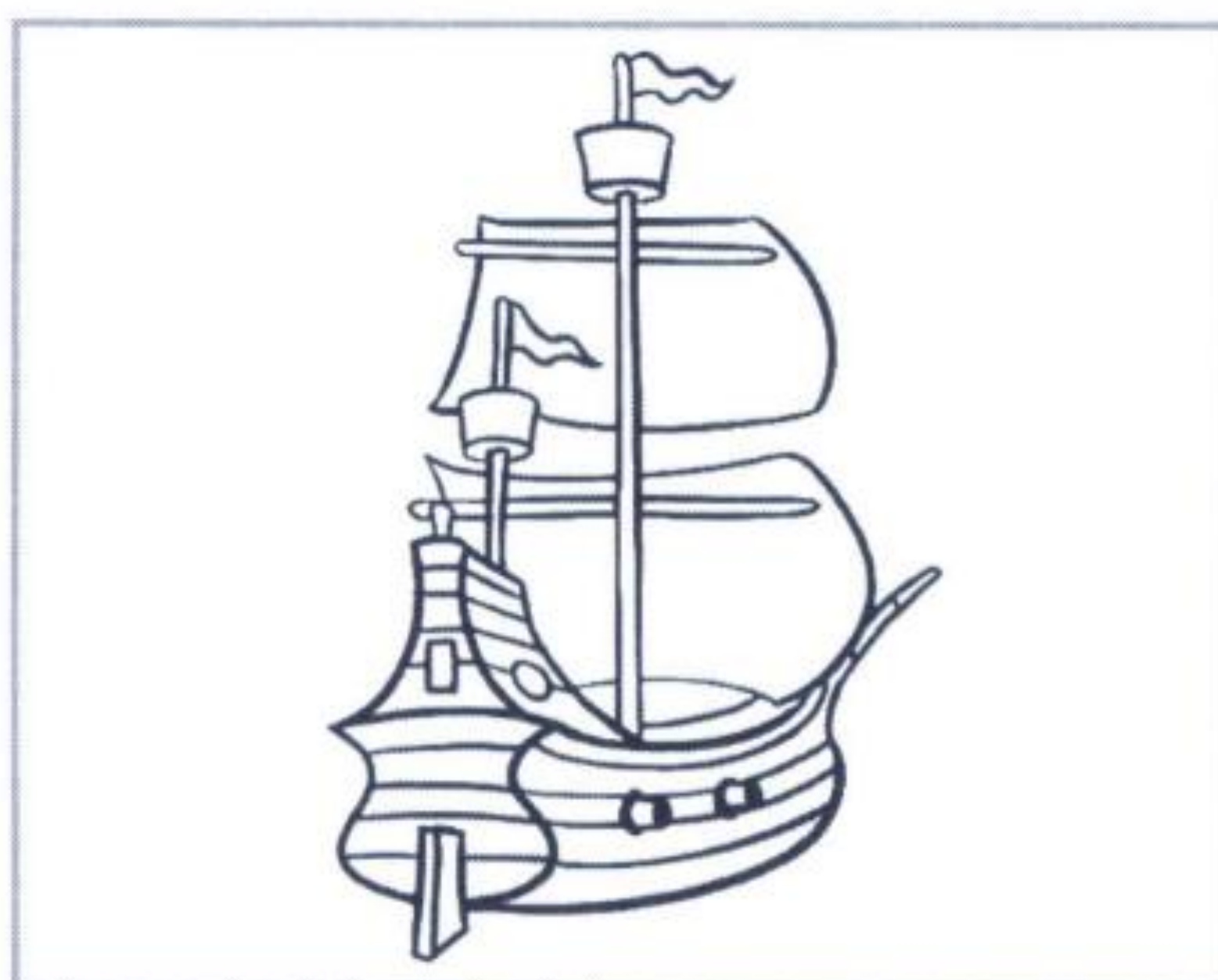

VA ___ LLO

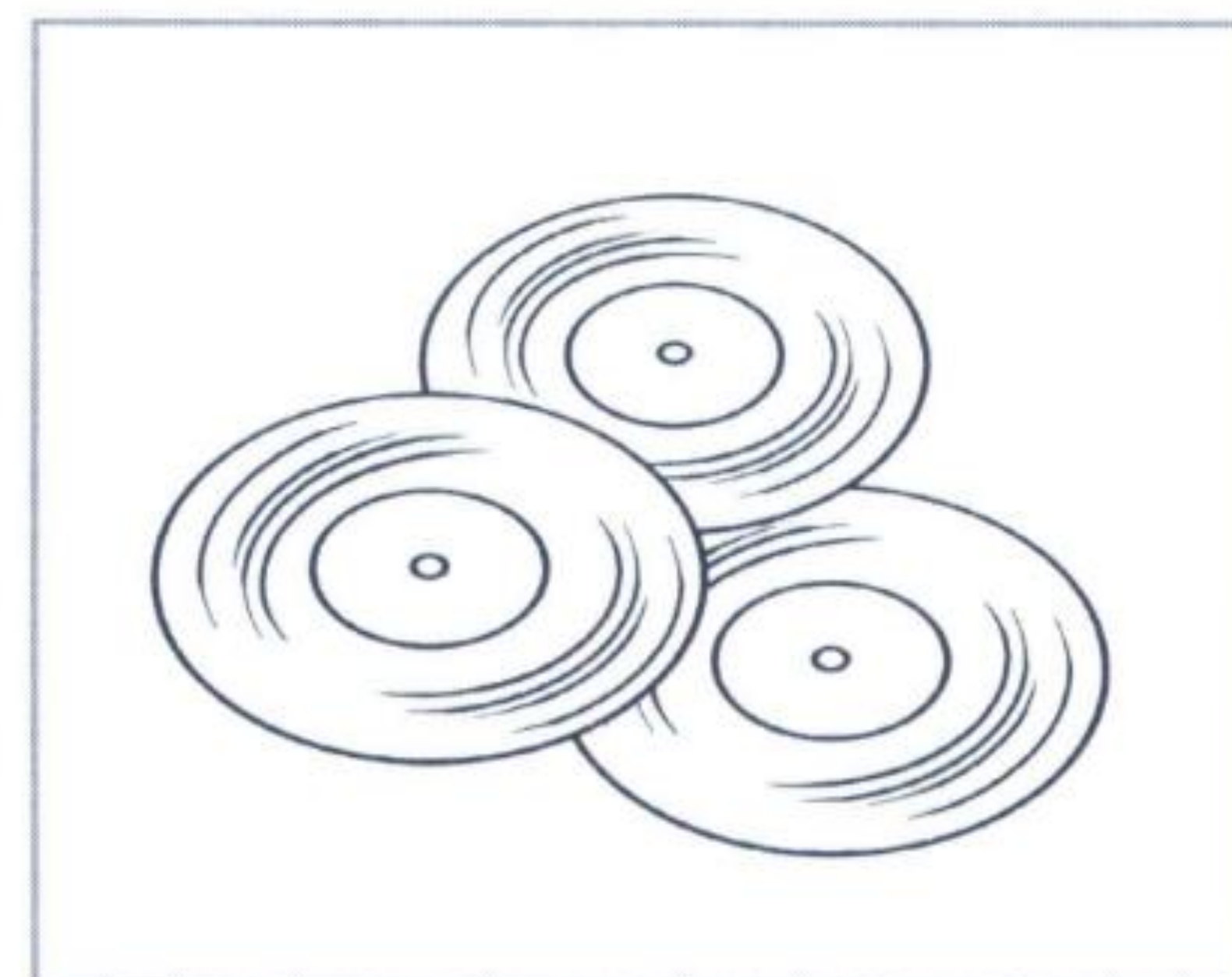

DI ___



___ ARPA

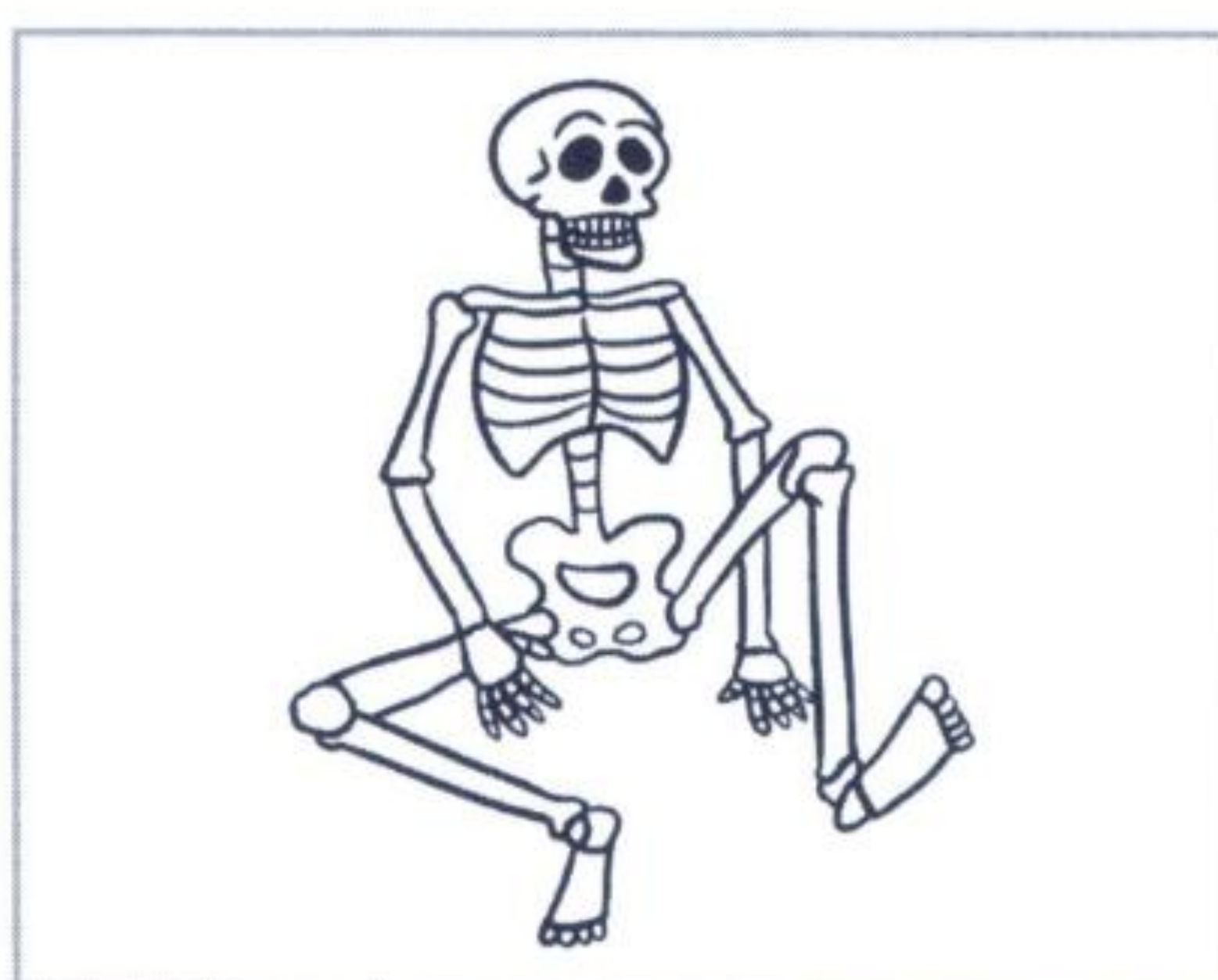

___ LETRO

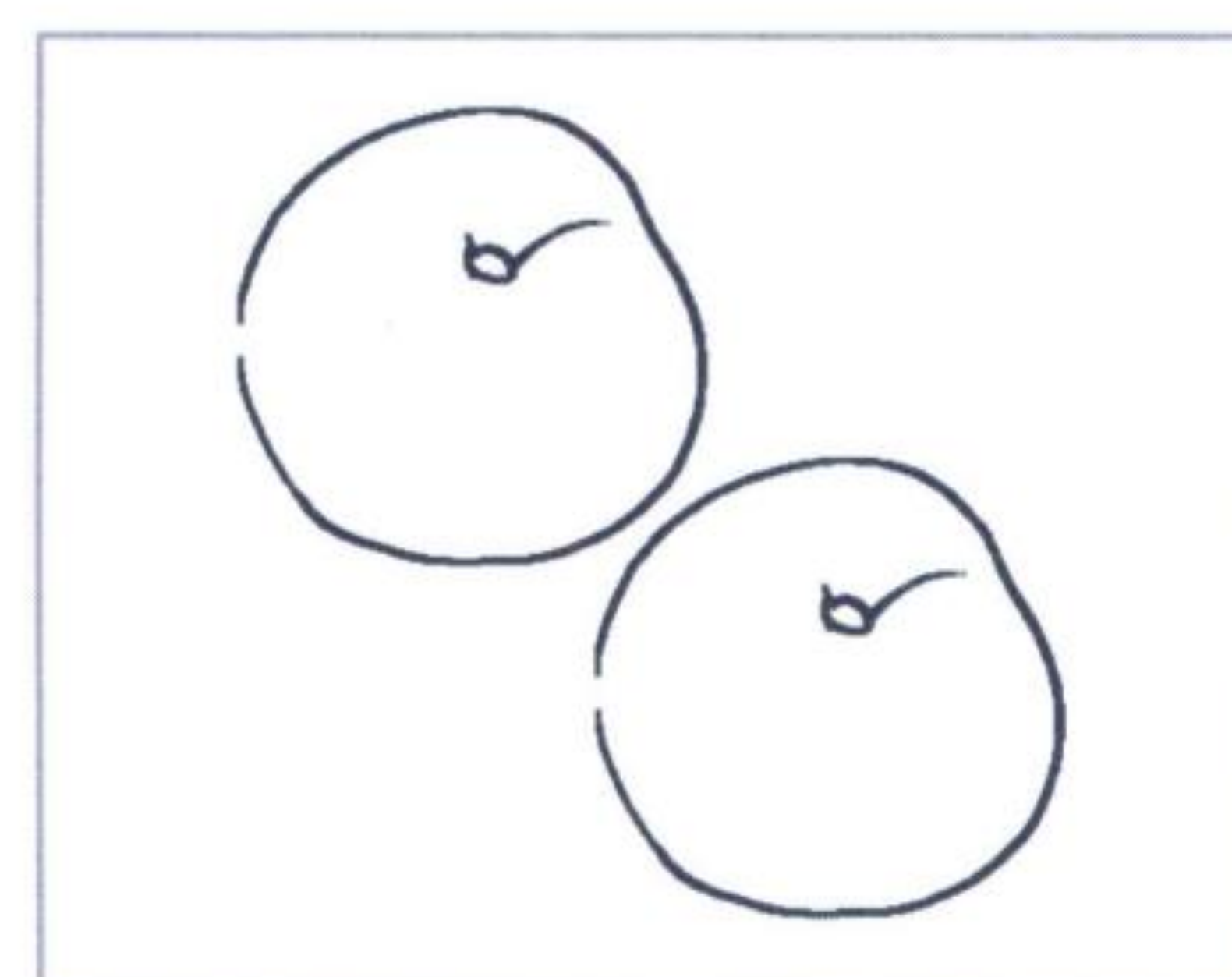

PE ___



___ MMIA



TA ___

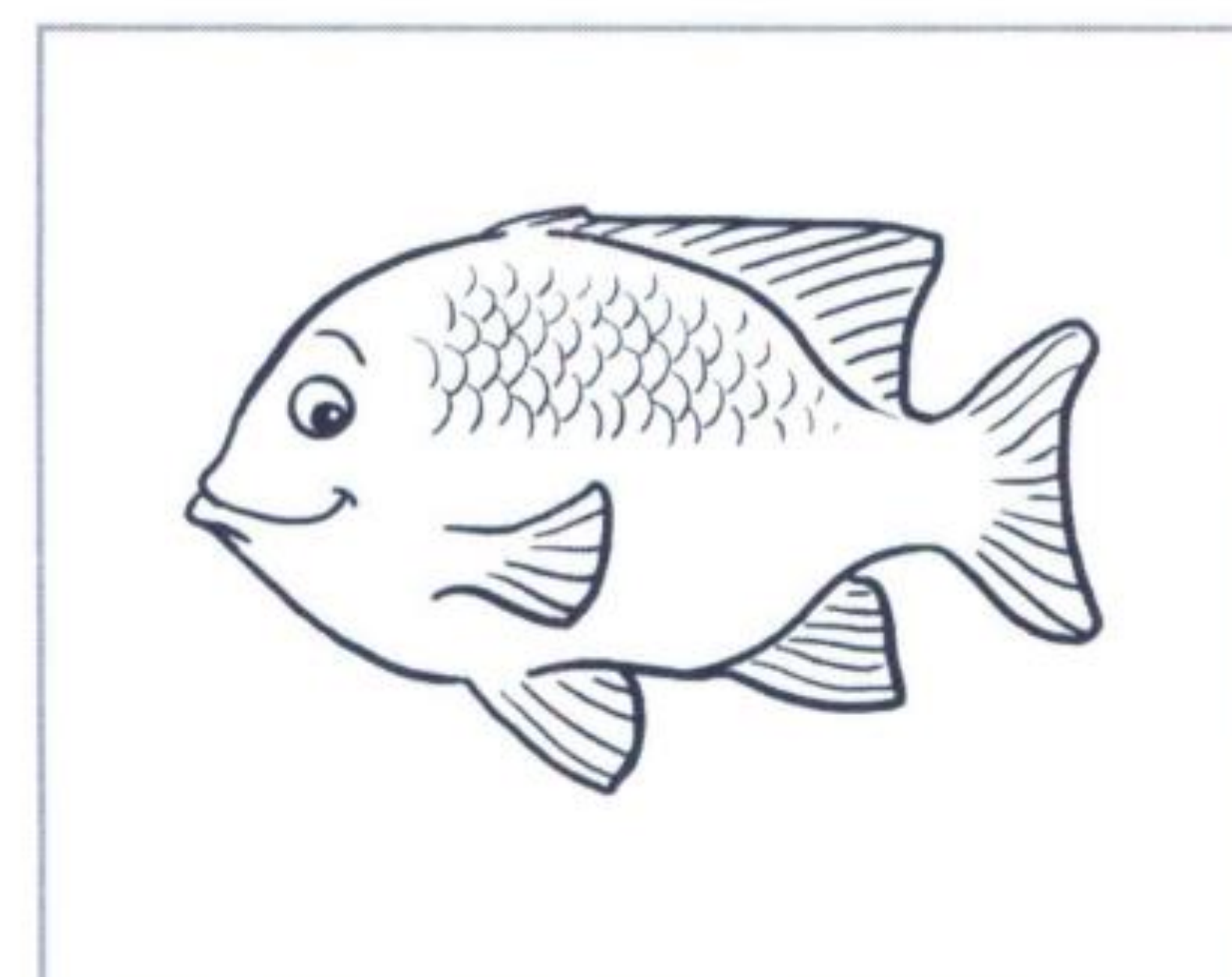

PE ___

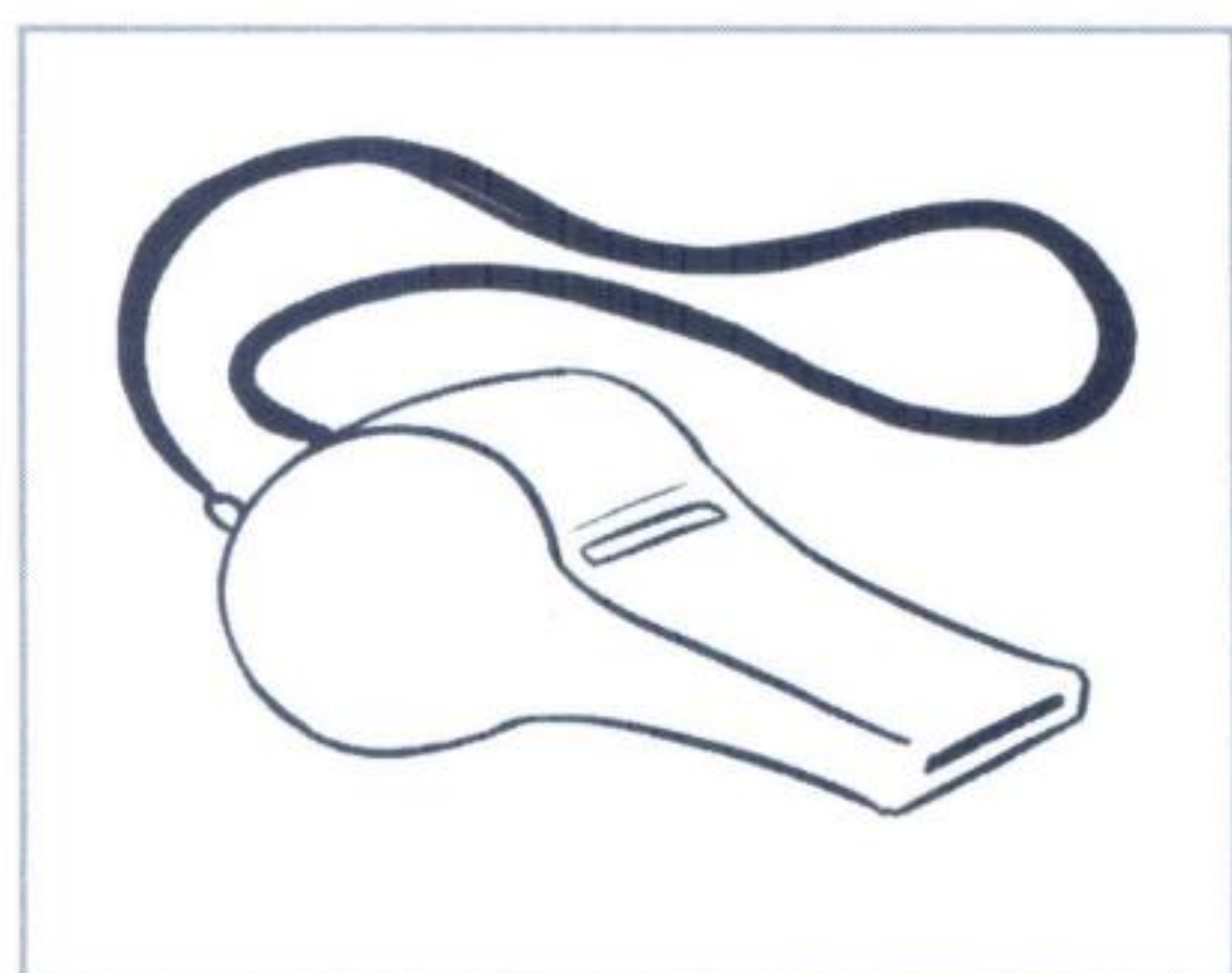

FI ___ ETTO

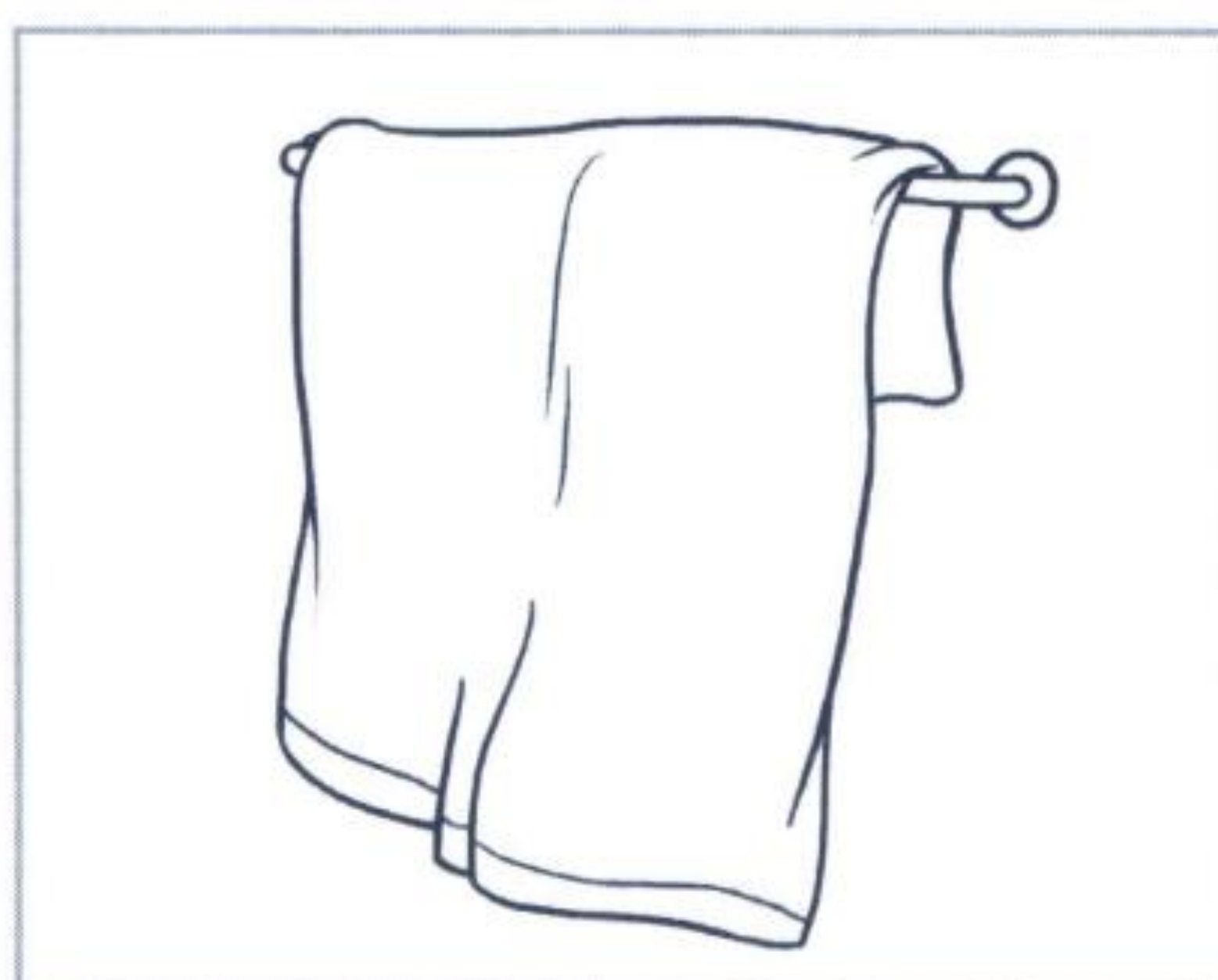

A ___ UGAMANO

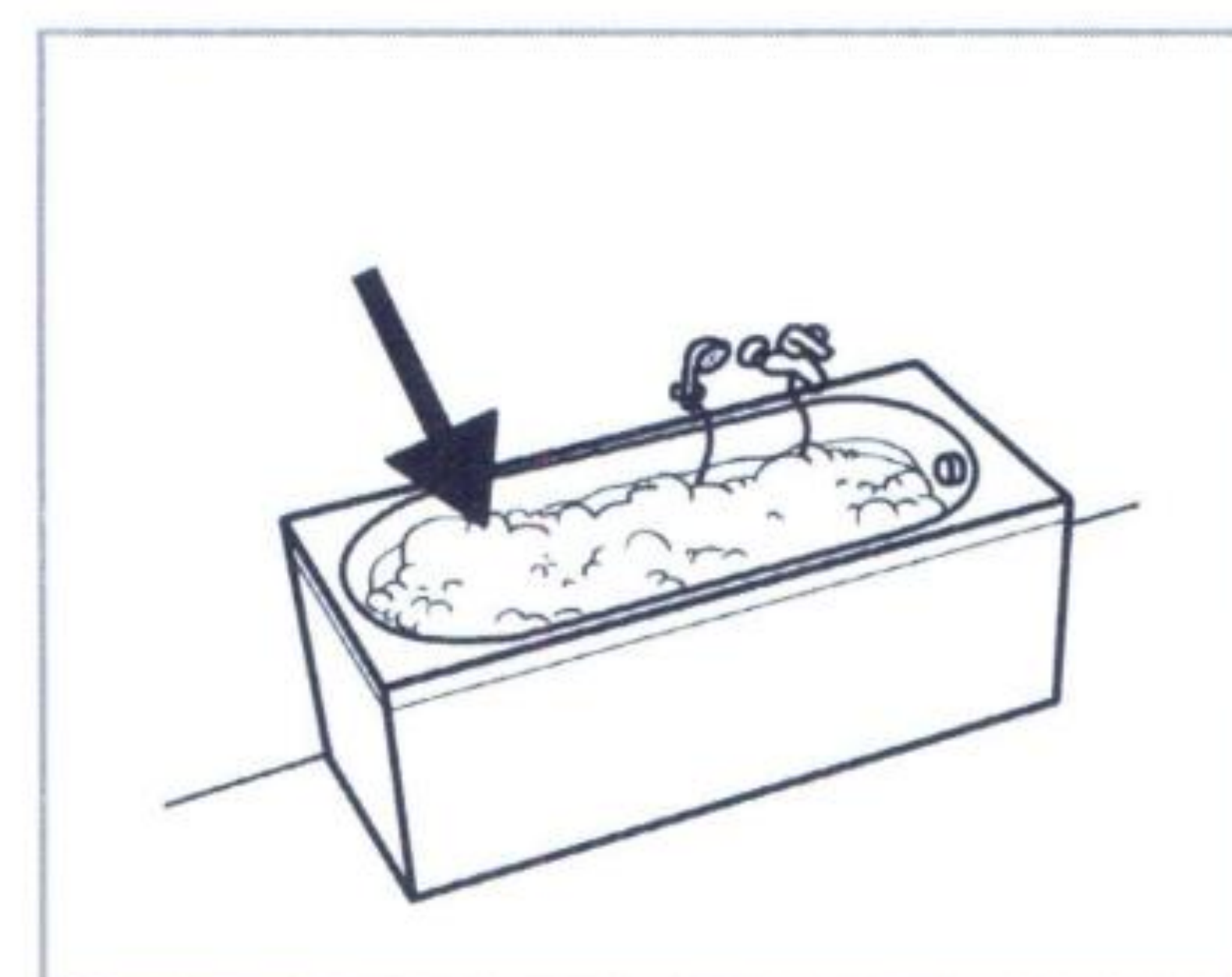

___ UMA



COMPLETA LE PAROLE INSERENDO «QUA», «QUE»,
«QUI» O «QUO»

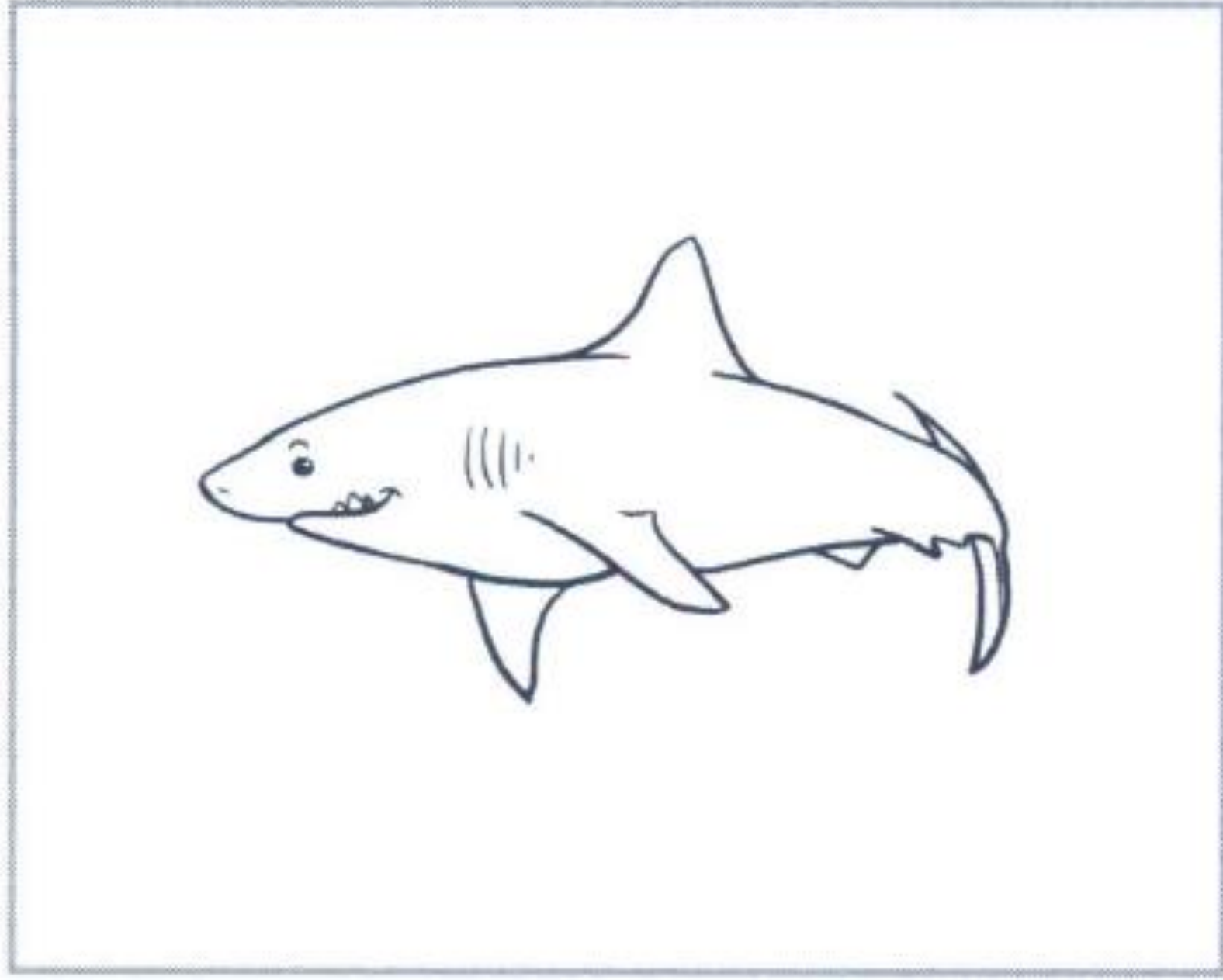

S _ _ LO

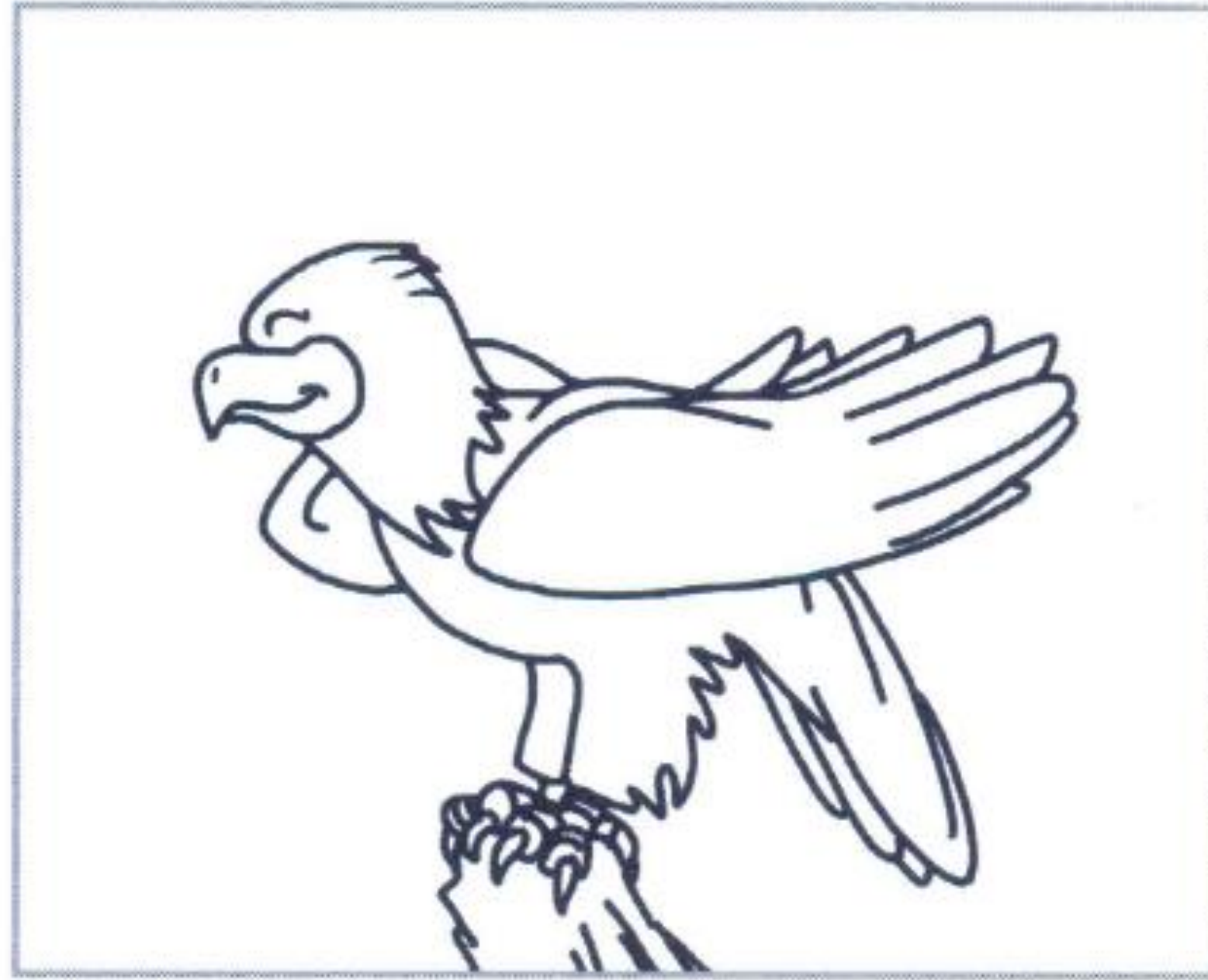

A _ _ LA

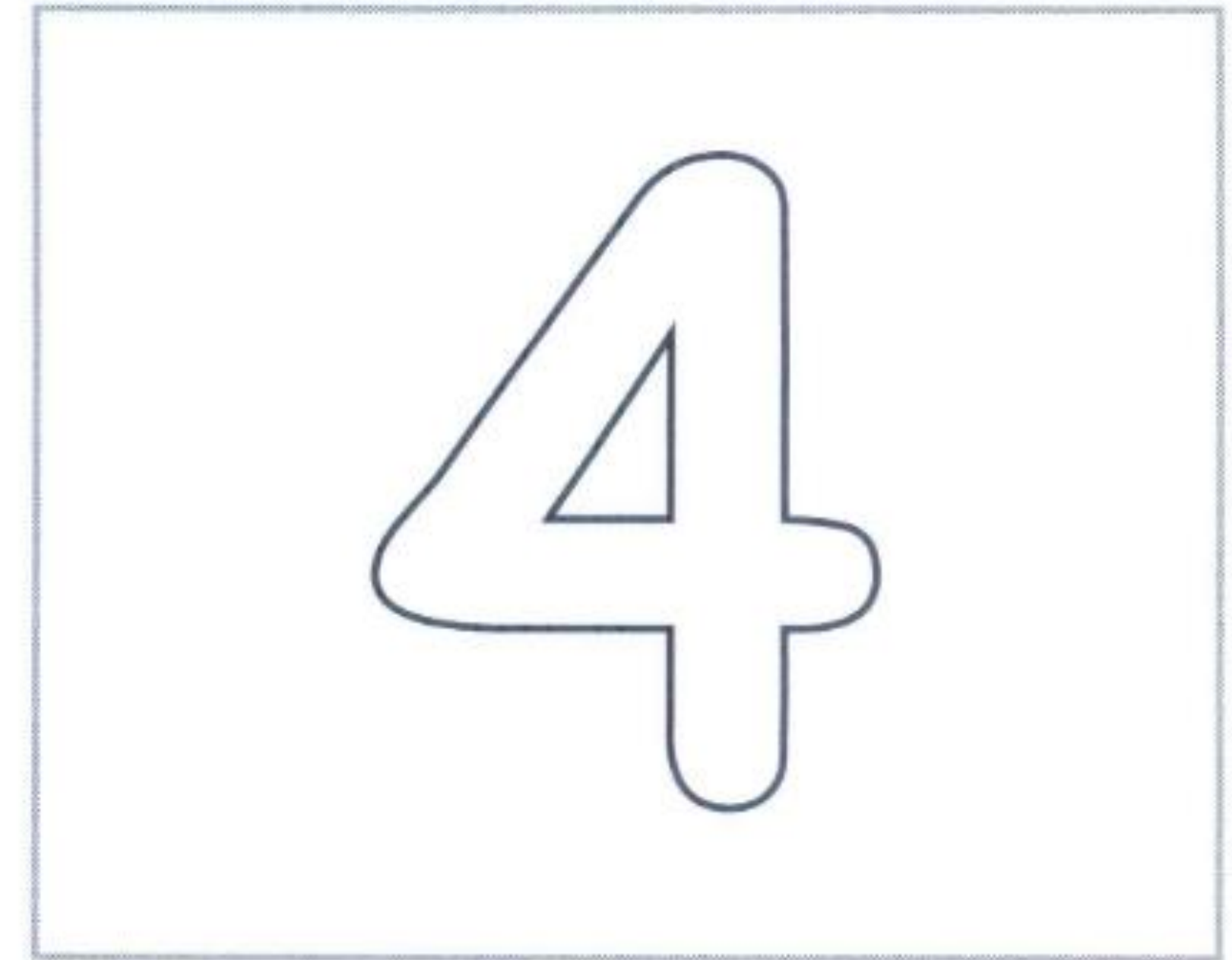

_ _ TTRO



LI _ _ RIZIA



_ _ DERNO



_ _ NDICI

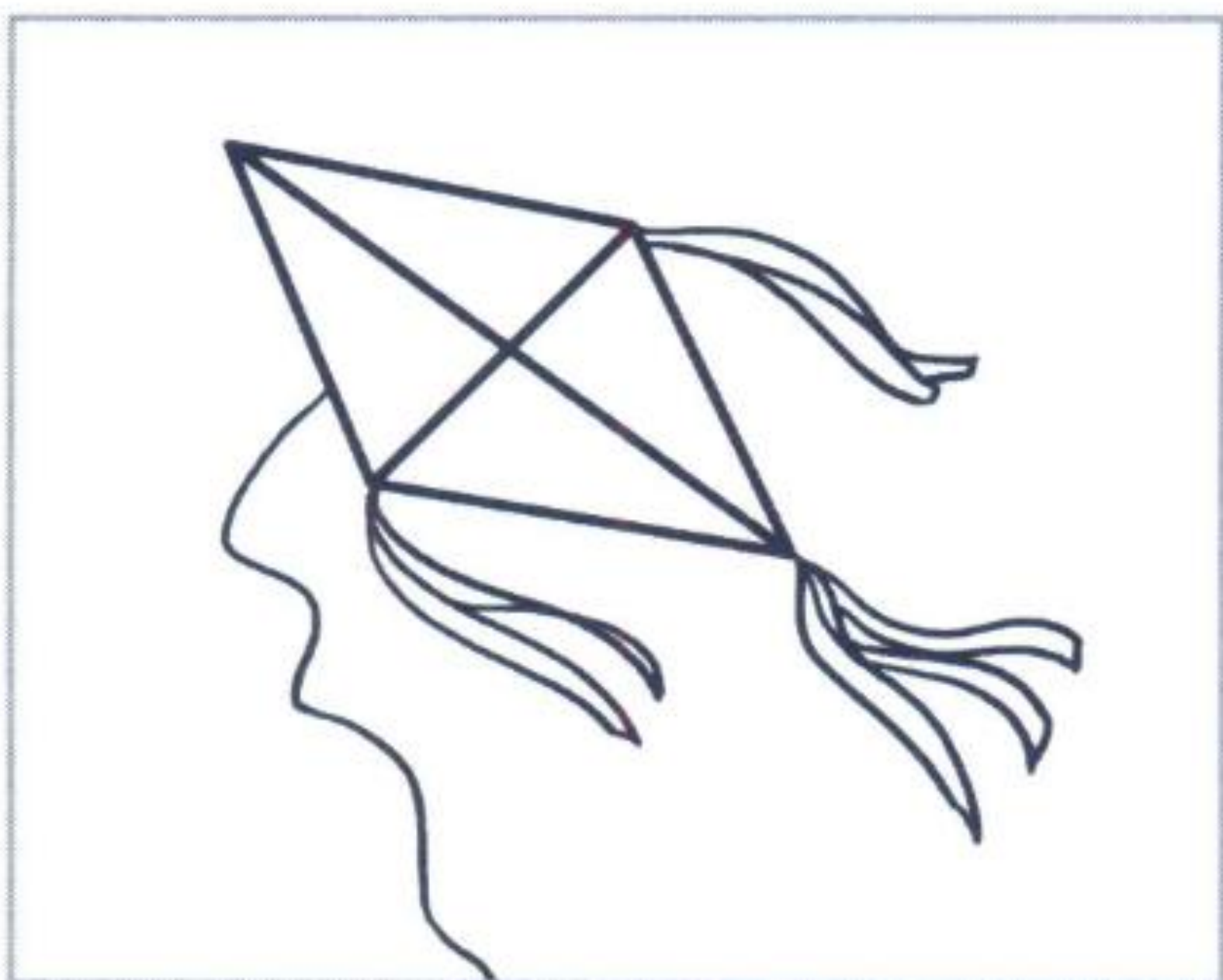

A _ _ LONE

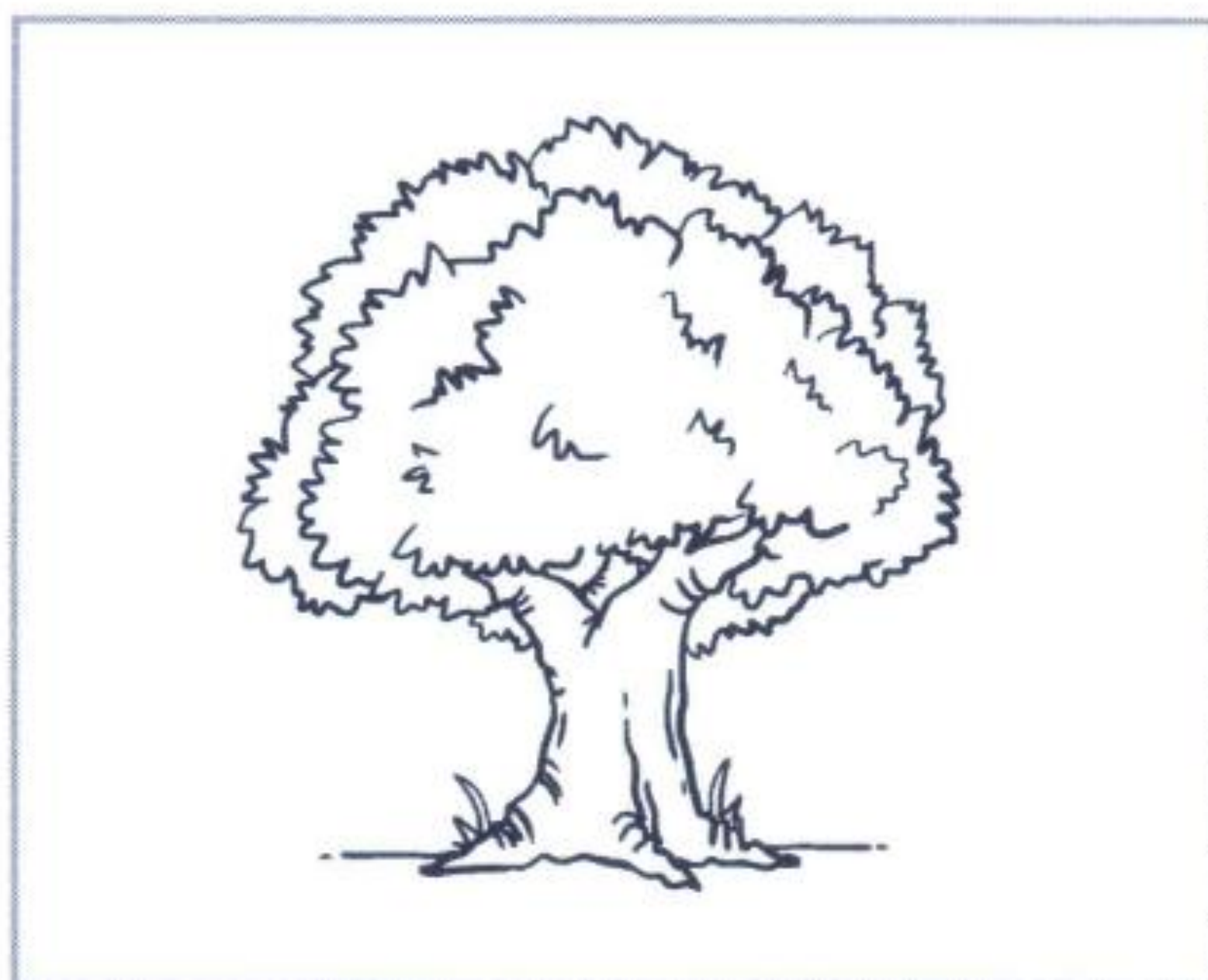

_ _ RCIA

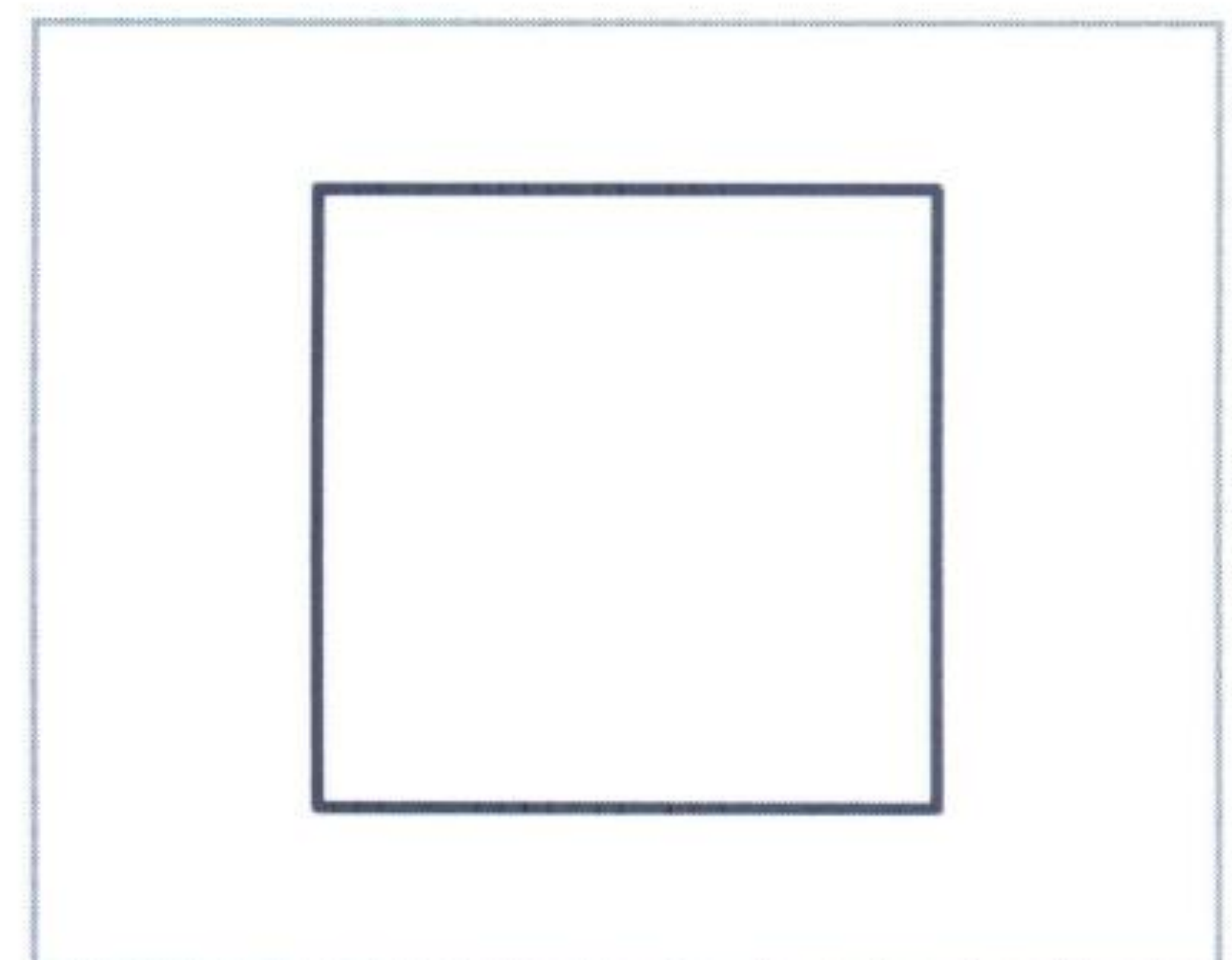

_ _ DRATO



LI _ _ RE

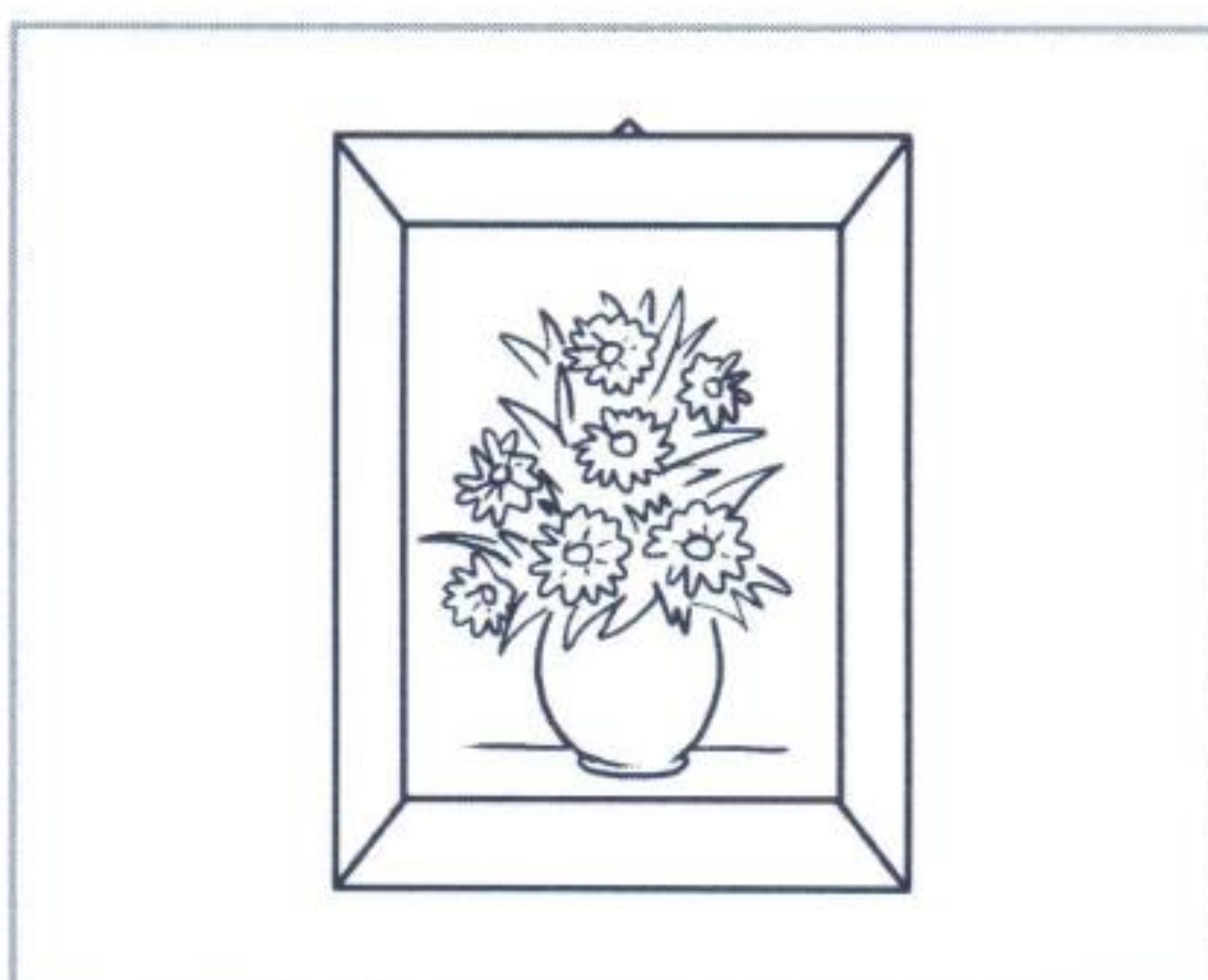

_ _ DRO



CIN _ _

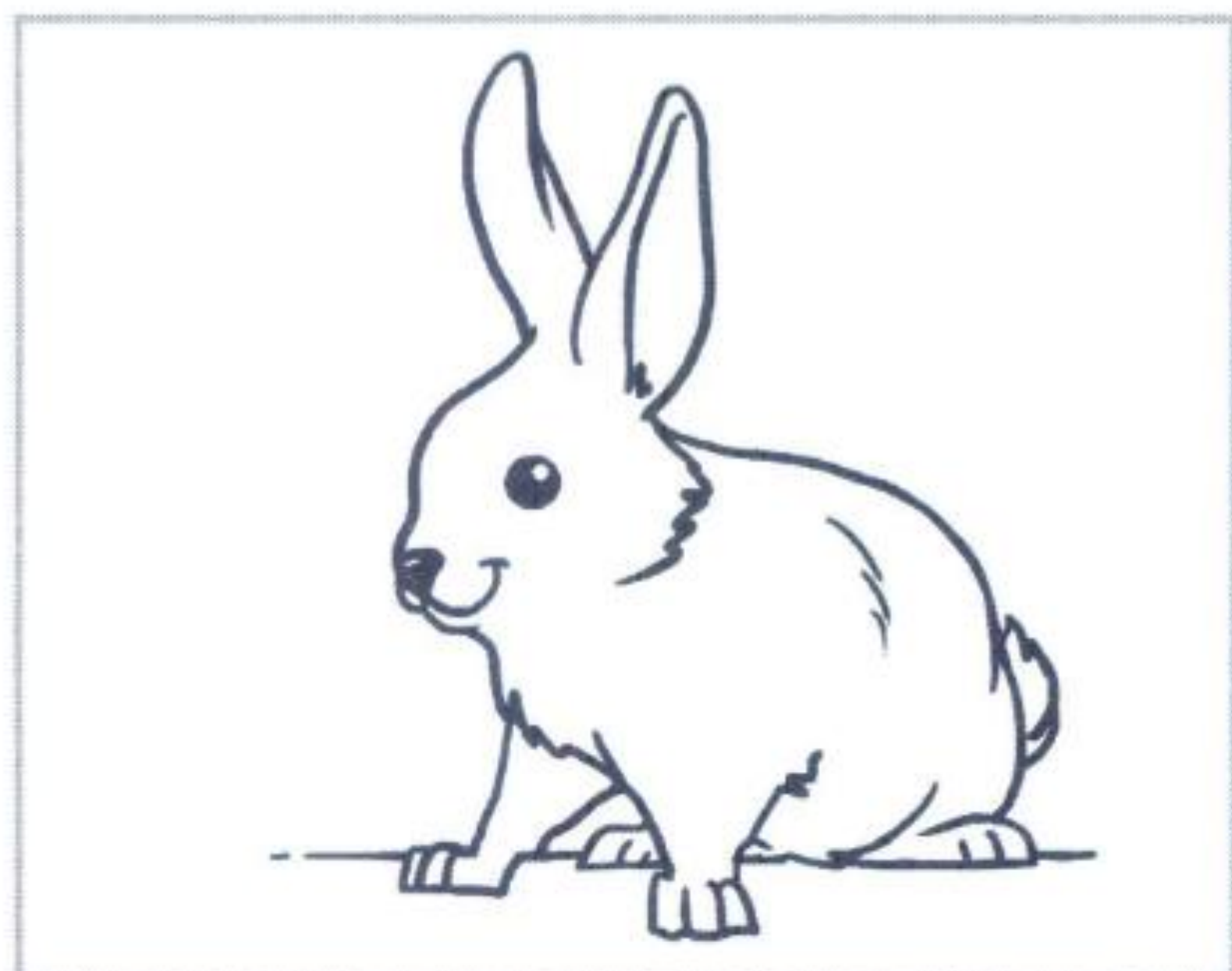

CONI _____



PA _____ CCIO



FO _____



MA _____ TTA

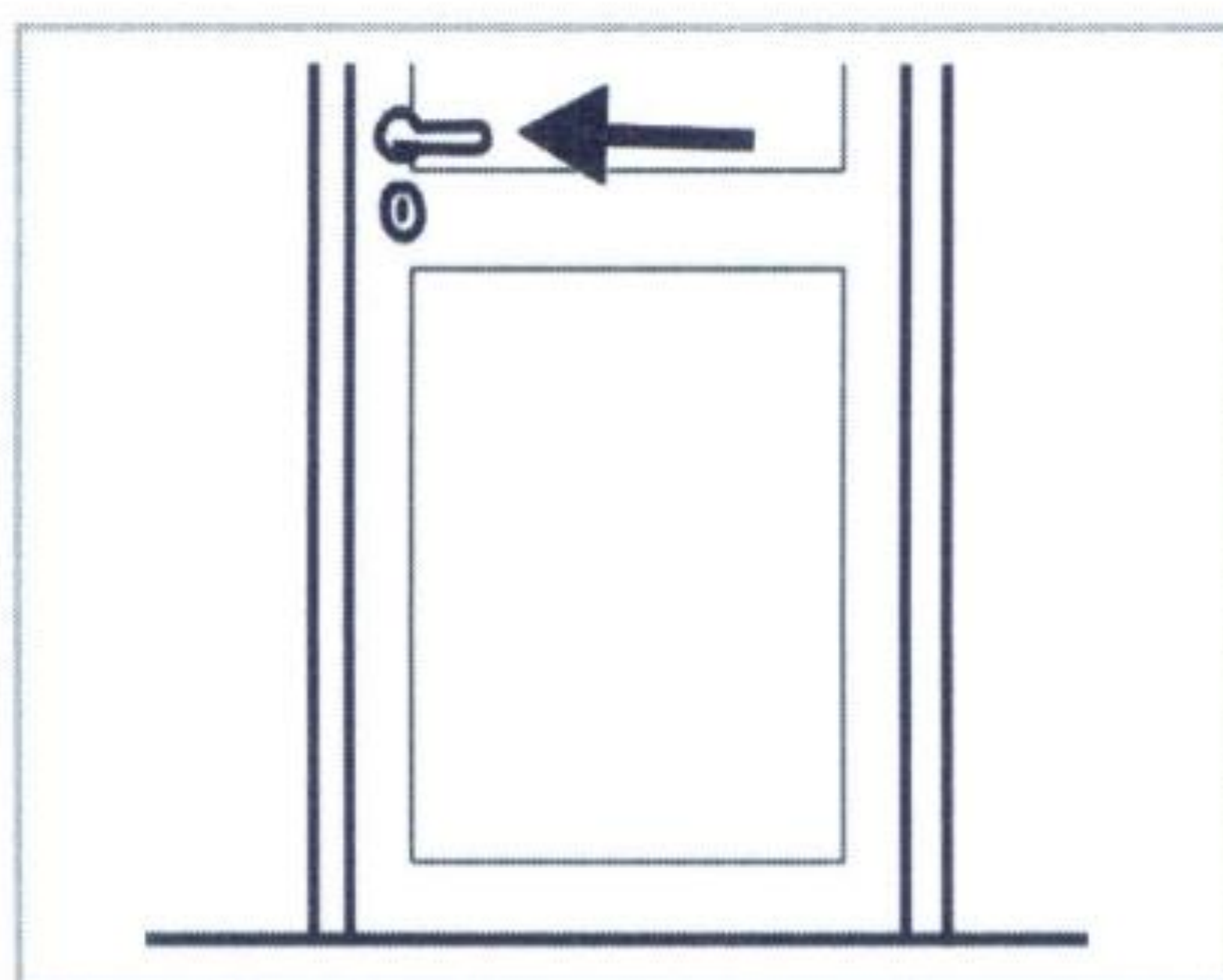

MANI _____

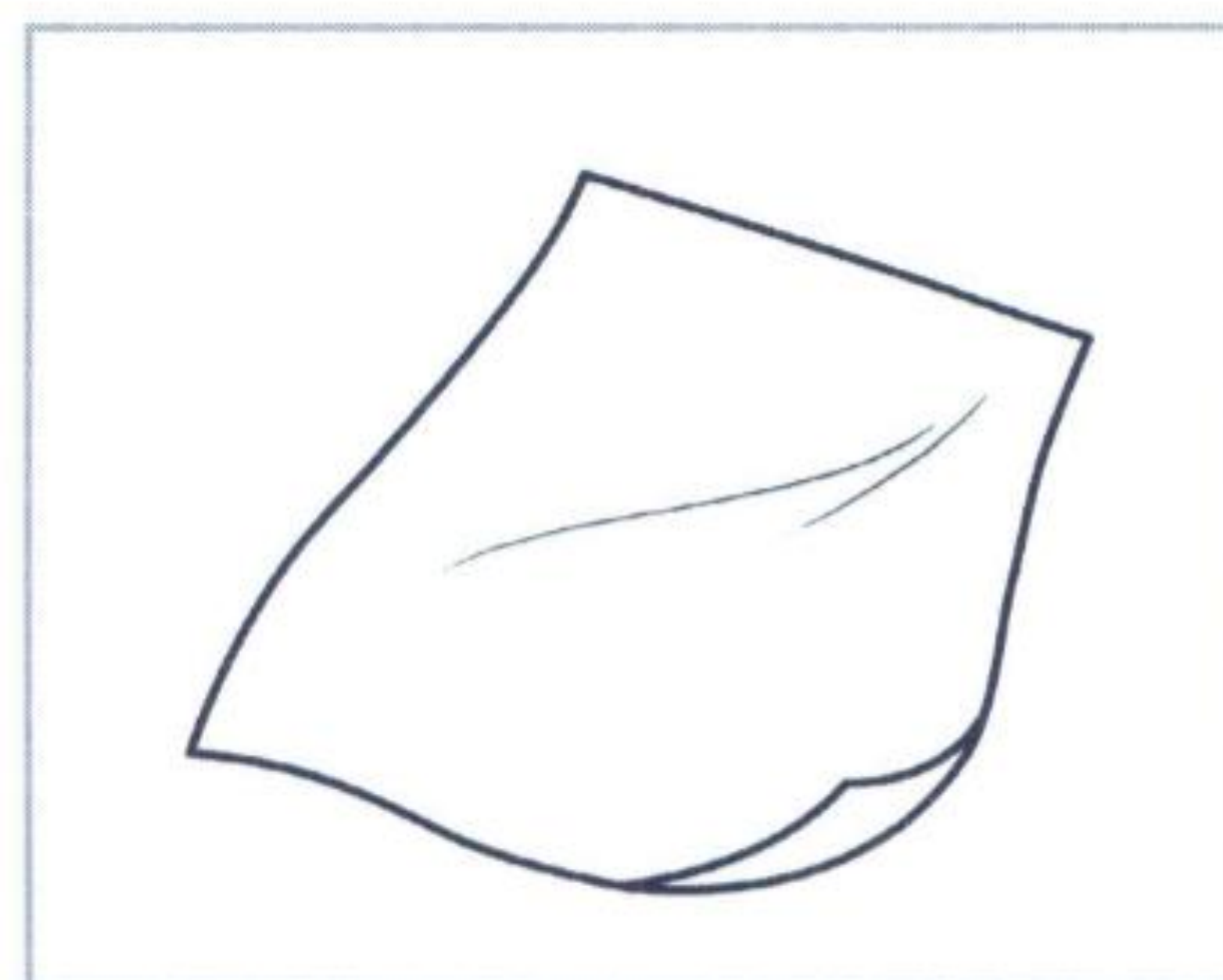

FO _____



SBADI _____

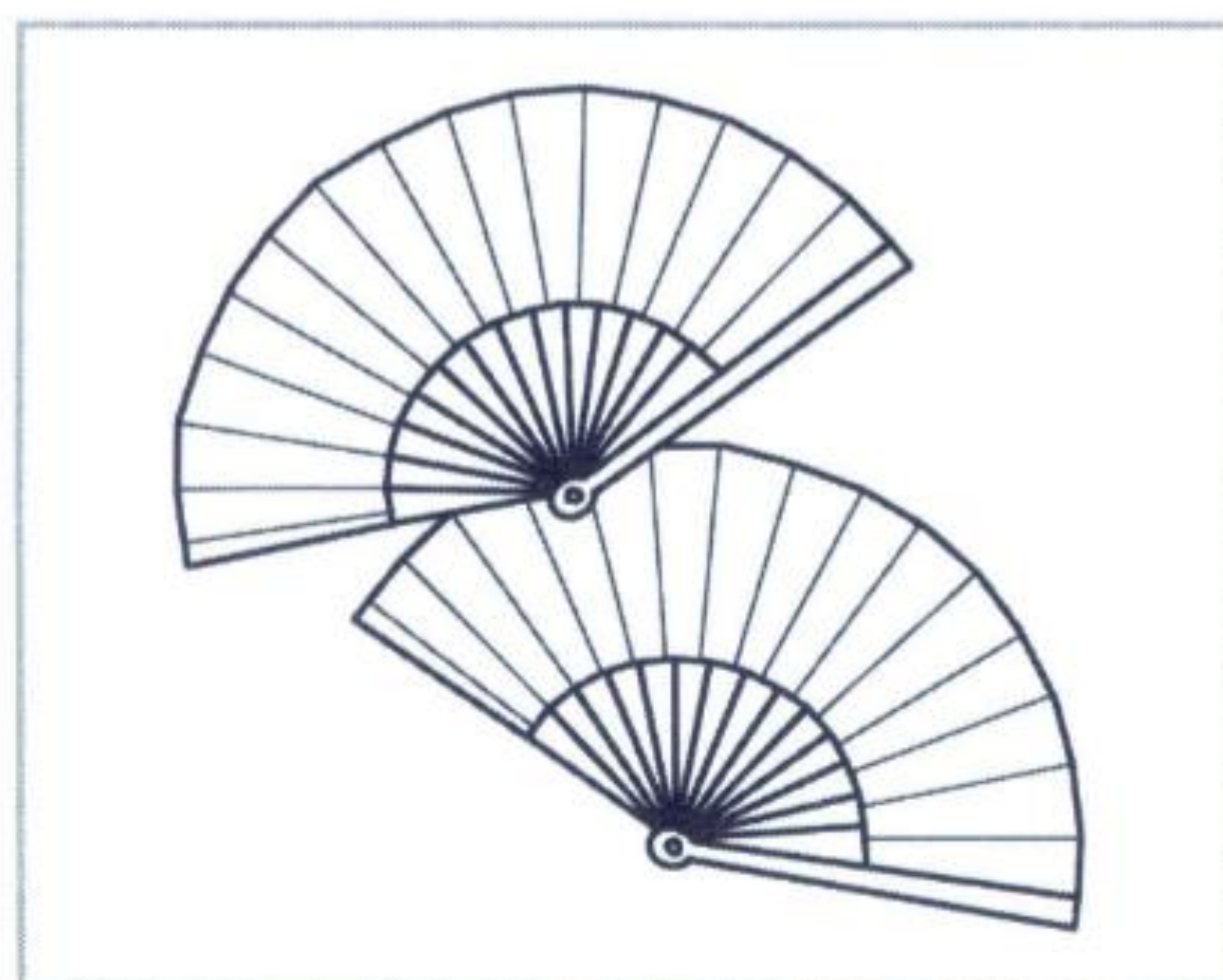

VENTA _____



CONCHI _____

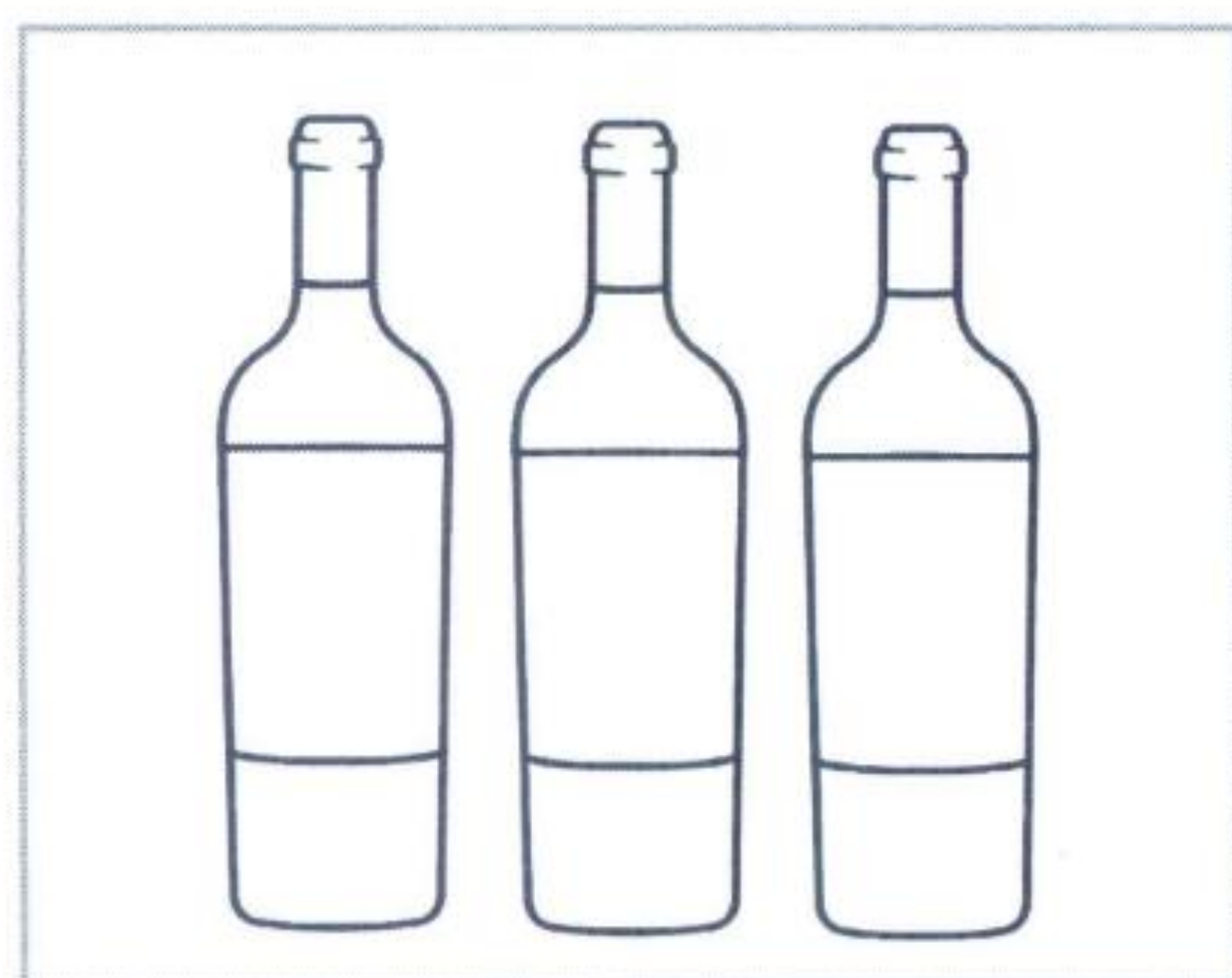

BOTTI _____

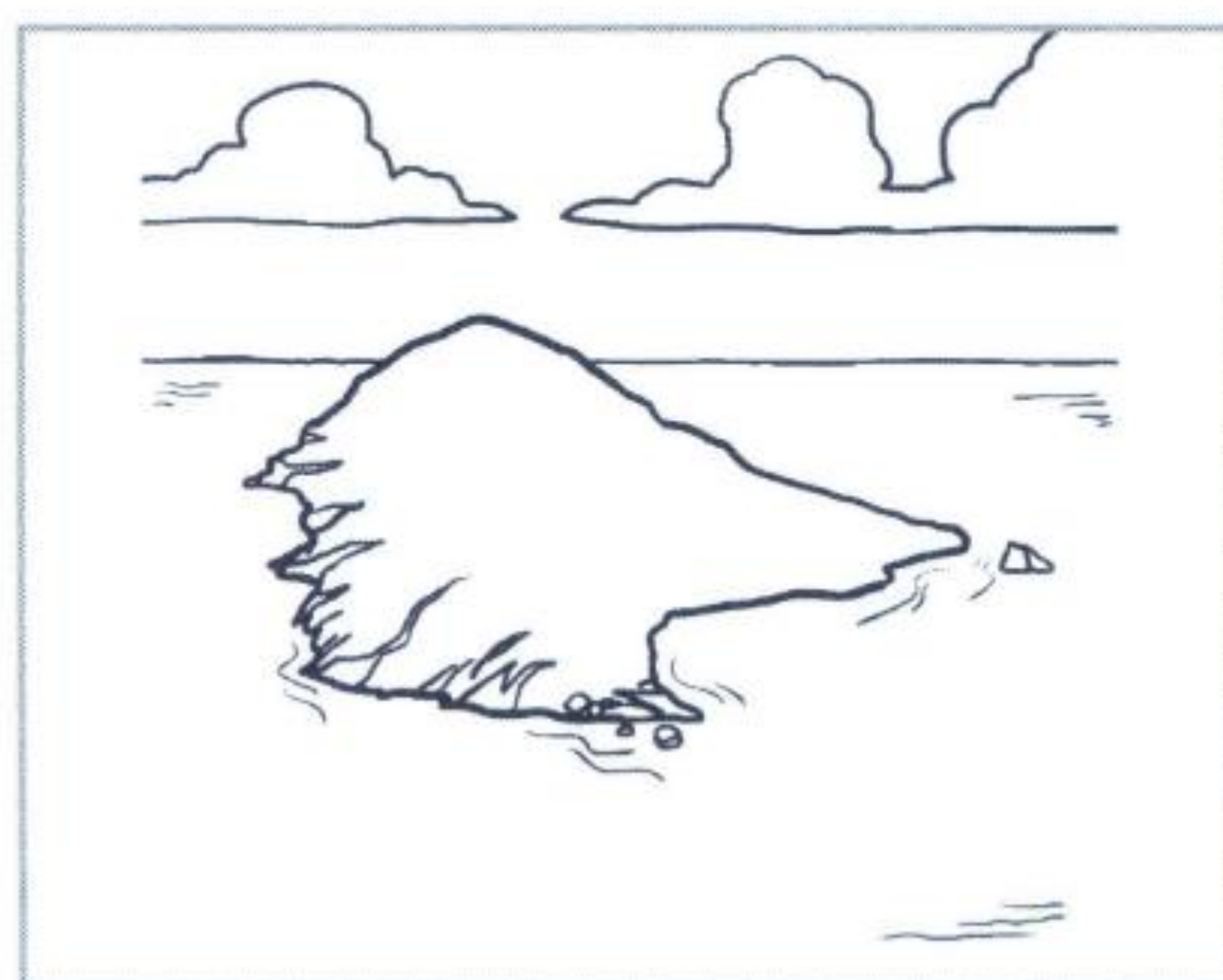

SCO _____

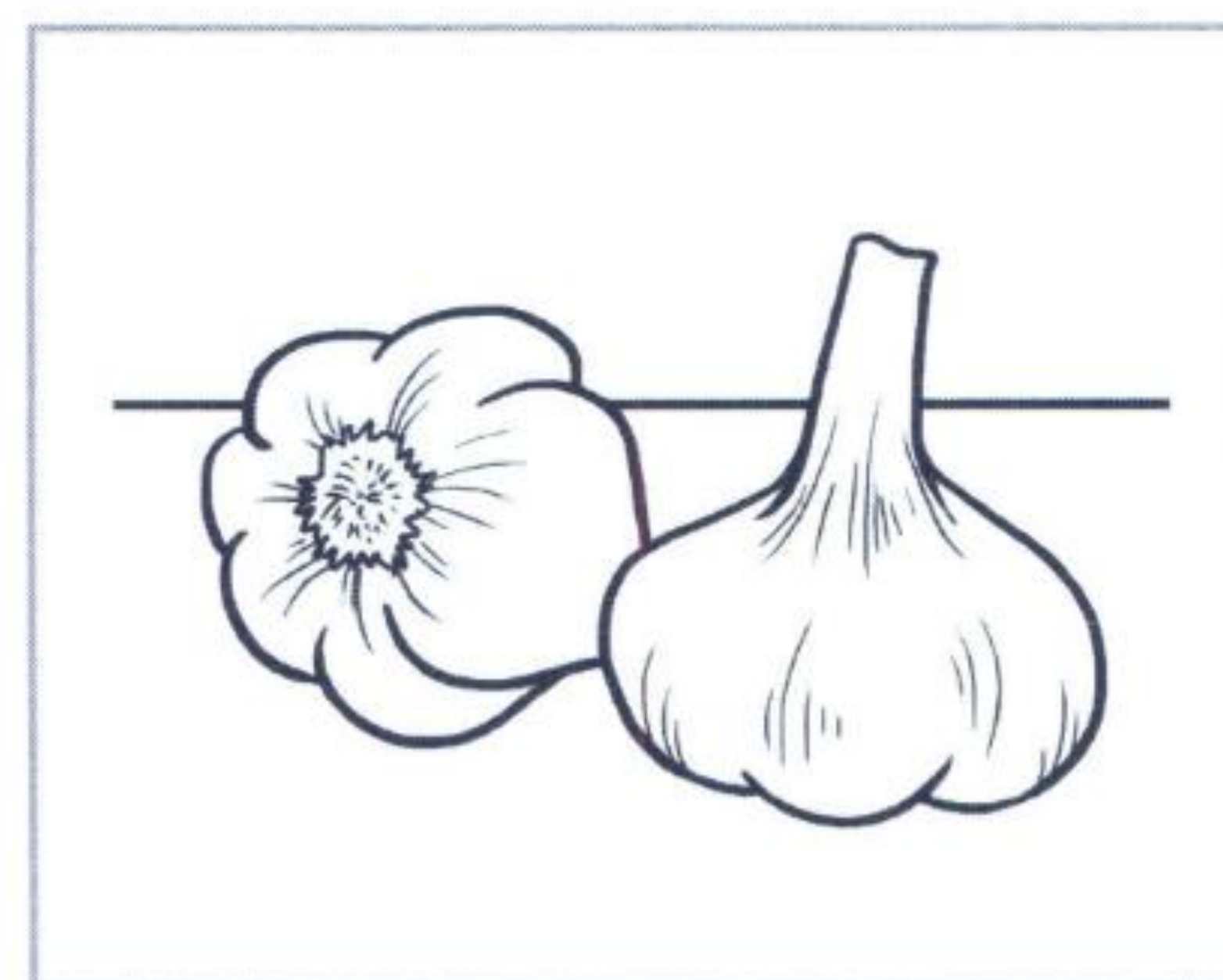

A _____